



Assembly code	Assembly description	Assembly image
ASM4288A/0.D00	General overview	
ASM4890A/0.D00	General overview	



**ASM4288A/0.D00 - General overview**

**FRONT**

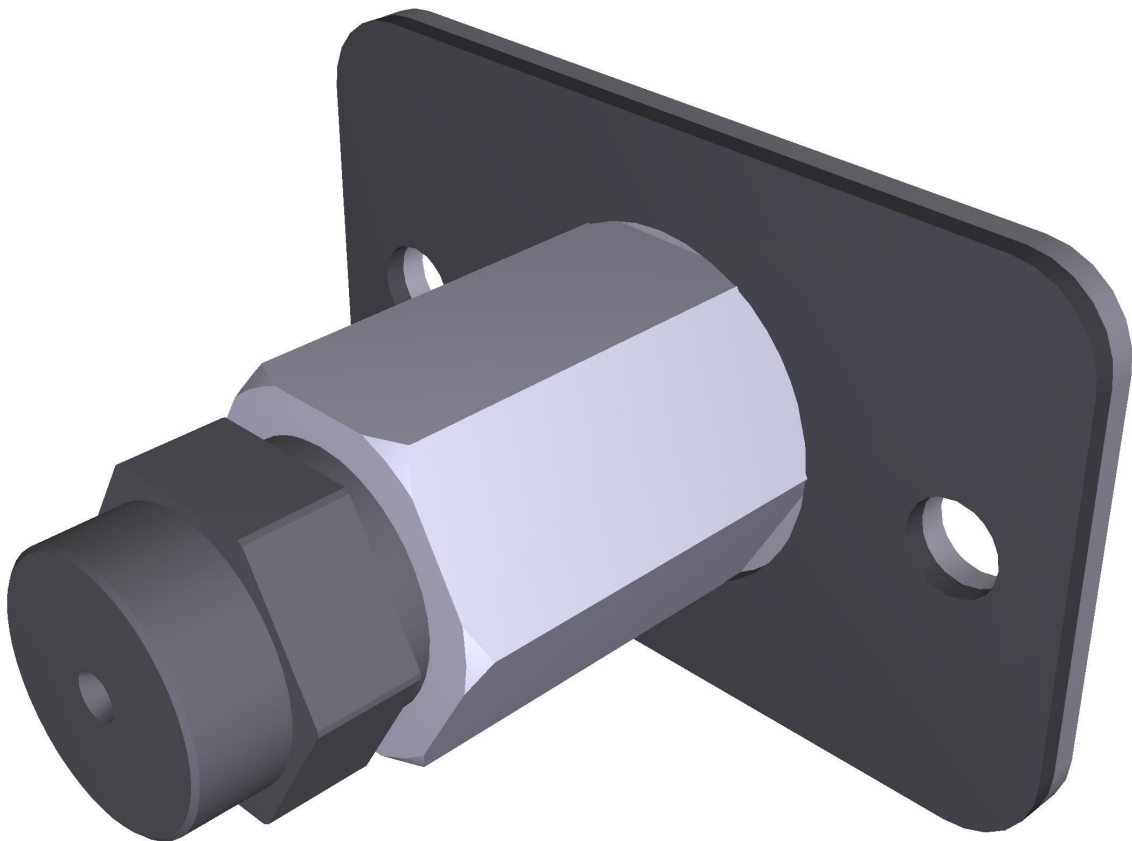



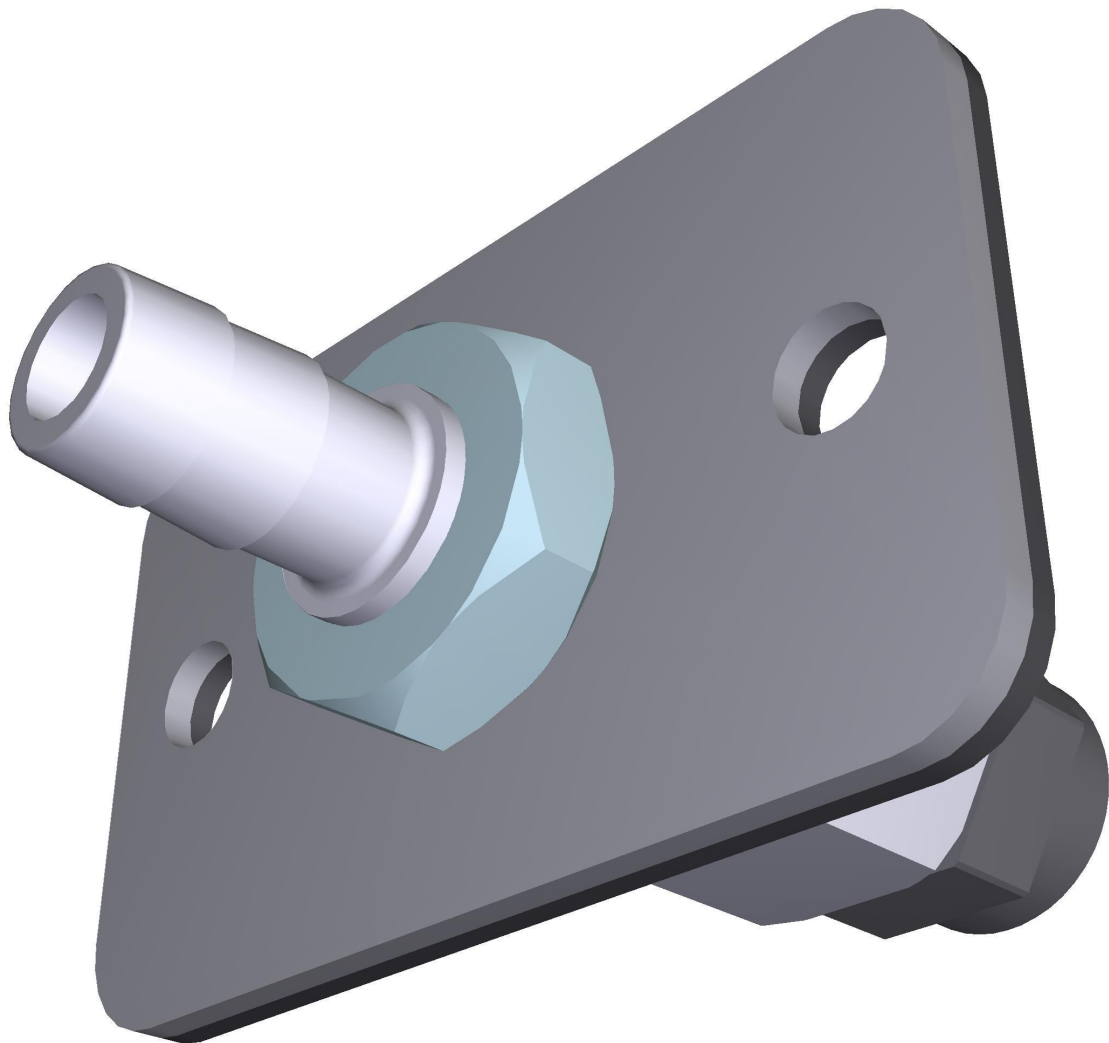

**ASM4288A/0.D00 - General overview**

**REAR**



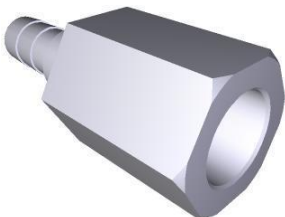

COMPONENT			SPARE PART										
Code	Description	Image	Code	Description	Kit components								
GN1608A	NOZZLE EXHAUST SEAL		GN1608A0	NOZZLE EXHAUST SEAL									
RC1400A	PROOFER TURNED FITTING		RC1400A1	PROOFER TURNED FITTING									
UG1004A	"XC415-515-625 1/8" WATER NOZZLE"		KUG1004A	XC415-515-625 1/8" WATER NOZZLE KIT	<table border="1"> <thead> <tr> <th>Code</th> <th>Description</th> <th>Qty</th> <th>UOM</th> </tr> </thead> <tbody> <tr> <td>UG1004A0</td> <td>"XC415-515-625 1/8" WATER NOZZLE"</td> <td>1.000</td> <td>PC</td> </tr> </tbody> </table>	Code	Description	Qty	UOM	UG1004A0	"XC415-515-625 1/8" WATER NOZZLE"	1.000	PC
Code	Description	Qty	UOM										
UG1004A0	"XC415-515-625 1/8" WATER NOZZLE"	1.000	PC										



**ASM4890A/0.D00 - General overview**

**FRONT**

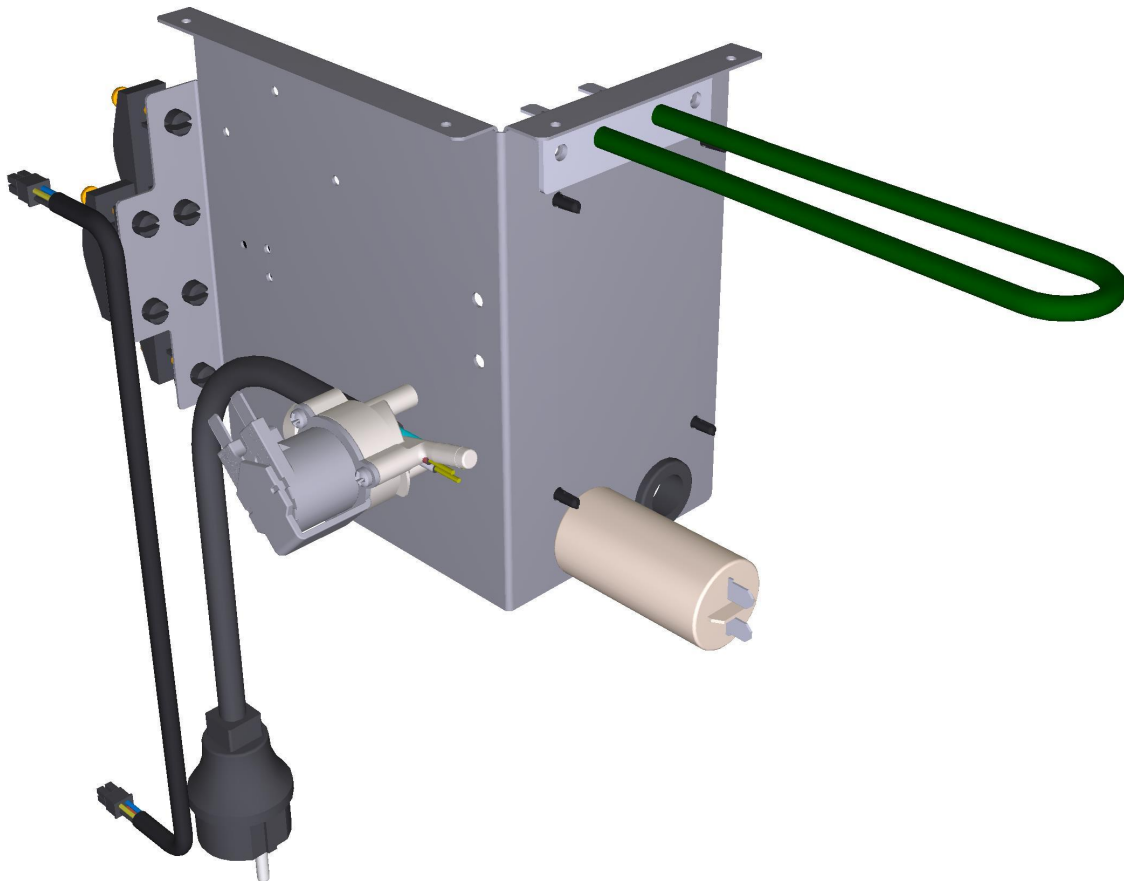

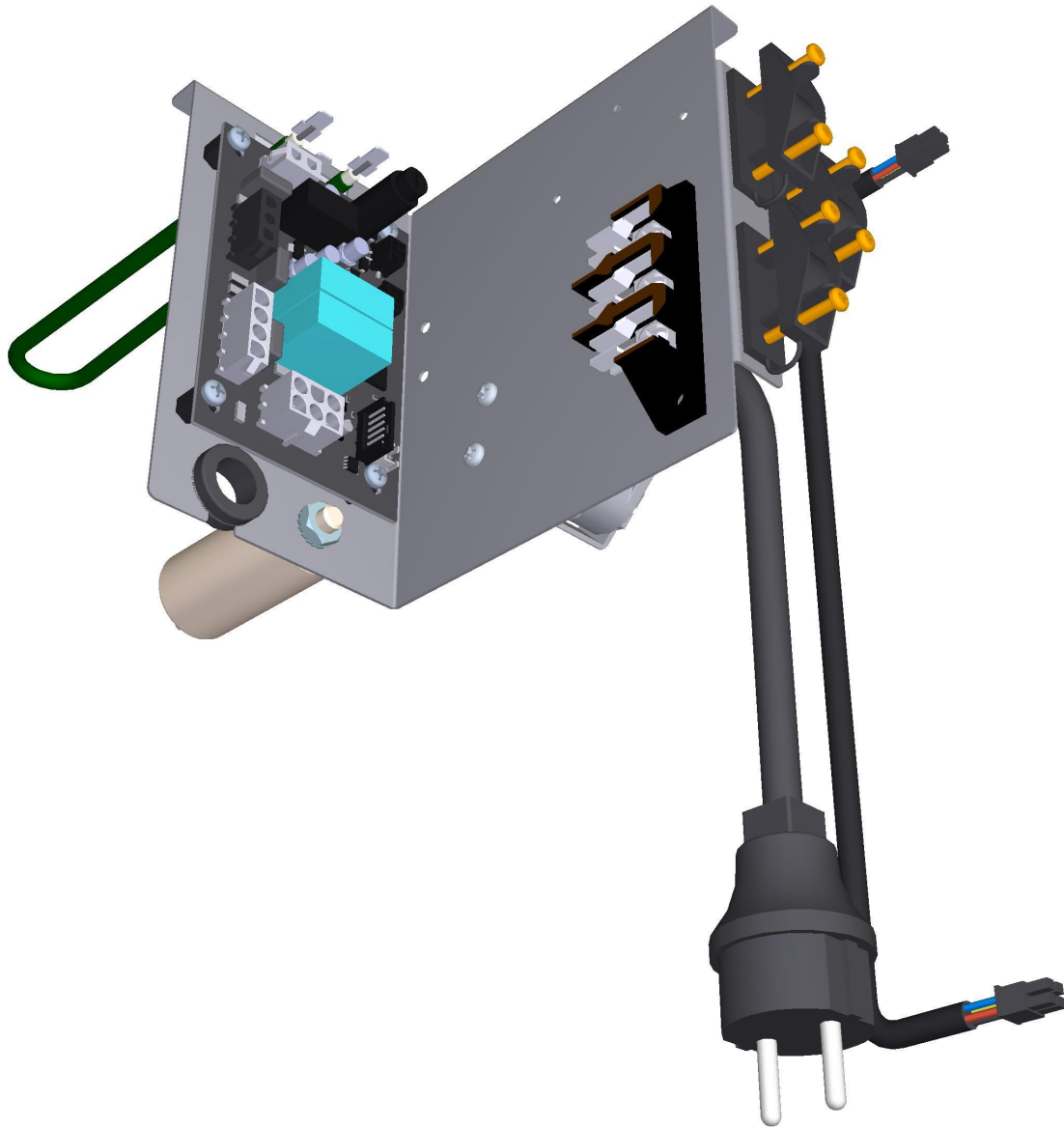

**ASM4890A/0.D00 - General overview**

**REAR**





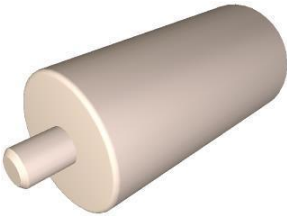
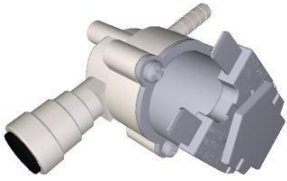

COMPONENT			SPARE PART																		
Code	Description	Image	Code	Description	Kit components																
0H7933A	SP800 CONDENSING HOOD UPPER BOARD PLATE		0H7933A0	SP800 CONDENSING HOOD UPPER BOARD PLATE																	
CE1095A	4 POLES MICROFIT 2 M BUS CABLE		KCE1095A	4POLES 2M BUS CABLE KIT POWER-CONTROL	<table border="1"> <thead> <tr> <th>Code</th> <th>Description</th> <th>Qty</th> <th>UOM</th> </tr> </thead> <tbody> <tr> <td>CE1095A0</td> <td>4 POLES MICROFIT 2 M BUS CABLE</td> <td>1.000</td> <td>PC</td> </tr> </tbody> </table>	Code	Description	Qty	UOM	CE1095A0	4 POLES MICROFIT 2 M BUS CABLE	1.000	PC								
Code	Description	Qty	UOM																		
CE1095A0	4 POLES MICROFIT 2 M BUS CABLE	1.000	PC																		
CE1581A	CABLE H07RNF 3G1.5 L1.5MT+K1/6+SCHU KO		KCE1581A	H07RNF 3G1.5 L1.5 MT + SHUKO PLUG KIT	<table border="1"> <thead> <tr> <th>Code</th> <th>Description</th> <th>Qty</th> <th>UOM</th> </tr> </thead> <tbody> <tr> <td>CE1581A0</td> <td>CABLE H07RNF 3G1.5 L1.5MT+K1/6+ SCHUKO</td> <td>1.000</td> <td>PC</td> </tr> </tbody> </table>	Code	Description	Qty	UOM	CE1581A0	CABLE H07RNF 3G1.5 L1.5MT+K1/6+ SCHUKO	1.000	PC								
Code	Description	Qty	UOM																		
CE1581A0	CABLE H07RNF 3G1.5 L1.5MT+K1/6+ SCHUKO	1.000	PC																		
CN1008A	MOTOR CAPACITOR 3,15µF 450V,CE/UL,P2 CL.		KCN1008A	MOTOR CAPACITOR 3,15µF 450V,CE/UL,P2 KIT	<table border="1"> <thead> <tr> <th>Code</th> <th>Description</th> <th>Qty</th> <th>UOM</th> </tr> </thead> <tbody> <tr> <td>CN1008A0</td> <td>MOTOR CAPACITOR 3,15µF 450V,CE/UL,P2 CL.</td> <td>1.000</td> <td>PC</td> </tr> <tr> <td>VI1931A0</td> <td>M8x1.65 H4 CH13 ZINC PLATED NUT</td> <td>1.000</td> <td>PC</td> </tr> <tr> <td>VI1932A0</td> <td>D8 INDENTED ZINC PLATED WASHER</td> <td>1.000</td> <td>PC</td> </tr> </tbody> </table>	Code	Description	Qty	UOM	CN1008A0	MOTOR CAPACITOR 3,15µF 450V,CE/UL,P2 CL.	1.000	PC	VI1931A0	M8x1.65 H4 CH13 ZINC PLATED NUT	1.000	PC	VI1932A0	D8 INDENTED ZINC PLATED WASHER	1.000	PC
Code	Description	Qty	UOM																		
CN1008A0	MOTOR CAPACITOR 3,15µF 450V,CE/UL,P2 CL.	1.000	PC																		
VI1931A0	M8x1.65 H4 CH13 ZINC PLATED NUT	1.000	PC																		
VI1932A0	D8 INDENTED ZINC PLATED WASHER	1.000	PC																		
EL1436A	H2O SOLENOID JG D8 CHECK VALVE		KEL1436B	D8 CONNECTION D6 NRV WATER VALVE KIT	<table border="1"> <thead> <tr> <th>Code</th> <th>Description</th> <th>Qty</th> <th>UOM</th> </tr> </thead> <tbody> <tr> <td>EL1436B0</td> <td>JG D8-BARBED D6 NRV WATER SOLENOID</td> <td>1.000</td> <td>PC</td> </tr> </tbody> </table>	Code	Description	Qty	UOM	EL1436B0	JG D8-BARBED D6 NRV WATER SOLENOID	1.000	PC								
Code	Description	Qty	UOM																		
EL1436B0	JG D8-BARBED D6 NRV WATER SOLENOID	1.000	PC																		





COMPONENT			SPARE PART																																																																										
Code	Description	Image	Code	Description	Kit components																																																																								
GN1312A	RUBBER CABLE-PASSING DE=26 DI=15 SP=10		KVL0001A	LM TOP CLEANING SYSTEM KIT	<table border="1"> <thead> <tr> <th>Code</th> <th>Description</th> <th>Qty</th> <th>UOM</th> </tr> </thead> <tbody> <tr> <td>0H1226B0</td> <td>LineMissTop WASHING SYTEM CIRCUIT COVE</td> <td>1.000</td> <td>PC</td> </tr> <tr> <td>EL1436B0</td> <td>JG D8-BARBED D6 NRV WATER SOLENOID</td> <td>1.000</td> <td>PC</td> </tr> <tr> <td>GN1312A0</td> <td>RUBBER CABLE-PASSI NG DE=26 DI=15 SP=10</td> <td>1.000</td> <td>PC</td> </tr> <tr> <td>GN1526A0</td> <td>INT. D.=6.9 TH=1.8 O-RIN</td> <td>1.000</td> <td>PC</td> </tr> <tr> <td>RC1019A0</td> <td>D=10 ELASTIC CLAMP</td> <td>5.000</td> <td>PC</td> </tr> <tr> <td>RC1242A0</td> <td>D=10 CLOSED CAP</td> <td>2.000</td> <td>PC</td> </tr> <tr> <td>RC1381A0</td> <td>BIFILAR PIPE CLIP D10.7</td> <td>3.000</td> <td>PC</td> </tr> <tr> <td>TB1114A1</td> <td>TB2820A-LM TOP DETERGENT PIPE COIL ROTOR</td> <td>1.000</td> <td>PC</td> </tr> <tr> <td>TB1116A0</td> <td>TB2343A-DETE RGENT HOLD DOWN WEIGHT PIPE</td> <td>1.000</td> <td>PC</td> </tr> <tr> <td>TB2821A0</td> <td>EPDM 6X10 L=40MM PIPE</td> <td>1.000</td> <td>PC</td> </tr> <tr> <td>VH1220A1</td> <td>4,2x12 TCB SELF-TAPPIN G SCREW</td> <td>1.000</td> <td>PC</td> </tr> <tr> <td>VL1019A0</td> <td>VIBRATION DETERGENT PUMP</td> <td>1.000</td> <td>PC</td> </tr> <tr> <td>VL1047A1</td> <td>D6 PIPE HOLDER - D8 J.G. TERMINAL</td> <td>1.000</td> <td>PC</td> </tr> <tr> <td>VL1053B0</td> <td>ONE WASHING SYS EXT DISTRIBUTOR</td> <td>1.000</td> <td>PC</td> </tr> <tr> <td>VL1054B0</td> <td>ONE WASHING SYS INLET DISTRIBUTOR</td> <td>1.000</td> <td>PC</td> </tr> <tr> <td>VL1061A0</td> <td>HOLD DOWN WEIGHT+NET FILTER+NON- RET. V.</td> <td>1.000</td> <td>PC</td> </tr> <tr> <td>VL1090A0</td> <td>1LT TANK UNOX.DET&amp;RI NSE CAP</td> <td>1.000</td> <td>PC</td> </tr> </tbody> </table>	Code	Description	Qty	UOM	0H1226B0	LineMissTop WASHING SYTEM CIRCUIT COVE	1.000	PC	EL1436B0	JG D8-BARBED D6 NRV WATER SOLENOID	1.000	PC	GN1312A0	RUBBER CABLE-PASSI NG DE=26 DI=15 SP=10	1.000	PC	GN1526A0	INT. D.=6.9 TH=1.8 O-RIN	1.000	PC	RC1019A0	D=10 ELASTIC CLAMP	5.000	PC	RC1242A0	D=10 CLOSED CAP	2.000	PC	RC1381A0	BIFILAR PIPE CLIP D10.7	3.000	PC	TB1114A1	TB2820A-LM TOP DETERGENT PIPE COIL ROTOR	1.000	PC	TB1116A0	TB2343A-DETE RGENT HOLD DOWN WEIGHT PIPE	1.000	PC	TB2821A0	EPDM 6X10 L=40MM PIPE	1.000	PC	VH1220A1	4,2x12 TCB SELF-TAPPIN G SCREW	1.000	PC	VL1019A0	VIBRATION DETERGENT PUMP	1.000	PC	VL1047A1	D6 PIPE HOLDER - D8 J.G. TERMINAL	1.000	PC	VL1053B0	ONE WASHING SYS EXT DISTRIBUTOR	1.000	PC	VL1054B0	ONE WASHING SYS INLET DISTRIBUTOR	1.000	PC	VL1061A0	HOLD DOWN WEIGHT+NET FILTER+NON- RET. V.	1.000	PC	VL1090A0	1LT TANK UNOX.DET&RI NSE CAP	1.000	PC
					Code	Description	Qty	UOM																																																																					
0H1226B0	LineMissTop WASHING SYTEM CIRCUIT COVE	1.000	PC																																																																										
EL1436B0	JG D8-BARBED D6 NRV WATER SOLENOID	1.000	PC																																																																										
GN1312A0	RUBBER CABLE-PASSI NG DE=26 DI=15 SP=10	1.000	PC																																																																										
GN1526A0	INT. D.=6.9 TH=1.8 O-RIN	1.000	PC																																																																										
RC1019A0	D=10 ELASTIC CLAMP	5.000	PC																																																																										
RC1242A0	D=10 CLOSED CAP	2.000	PC																																																																										
RC1381A0	BIFILAR PIPE CLIP D10.7	3.000	PC																																																																										
TB1114A1	TB2820A-LM TOP DETERGENT PIPE COIL ROTOR	1.000	PC																																																																										
TB1116A0	TB2343A-DETE RGENT HOLD DOWN WEIGHT PIPE	1.000	PC																																																																										
TB2821A0	EPDM 6X10 L=40MM PIPE	1.000	PC																																																																										
VH1220A1	4,2x12 TCB SELF-TAPPIN G SCREW	1.000	PC																																																																										
VL1019A0	VIBRATION DETERGENT PUMP	1.000	PC																																																																										
VL1047A1	D6 PIPE HOLDER - D8 J.G. TERMINAL	1.000	PC																																																																										
VL1053B0	ONE WASHING SYS EXT DISTRIBUTOR	1.000	PC																																																																										
VL1054B0	ONE WASHING SYS INLET DISTRIBUTOR	1.000	PC																																																																										
VL1061A0	HOLD DOWN WEIGHT+NET FILTER+NON- RET. V.	1.000	PC																																																																										
VL1090A0	1LT TANK UNOX.DET&RI NSE CAP	1.000	PC																																																																										

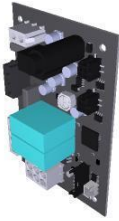
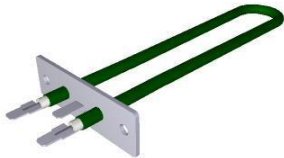

COMPONENT			SPARE PART																										
Code	Description	Image	Code	Description	Kit components																								
GN1312A	RUBBER CABLE-PASSING DE=26 DI=15 SP=10		KVL0001A	LM TOP CLEANING SYSTEM KIT	<table border="1"> <thead> <tr> <th>Code</th> <th>Description</th> <th>Qty</th> <th>UOM</th> </tr> </thead> <tbody> <tr> <td>VL1128A1</td> <td>D6 BARBED CHECK VALVE</td> <td>2.000</td> <td>PC</td> </tr> <tr> <td>VM1066A0</td> <td>SADDLE CLIP FOR CABLES PASSING</td> <td>3.000</td> <td>PC</td> </tr> <tr> <td>VM1088A0</td> <td>NYLON CLICK CLAMP D7.9-D9.2</td> <td>1.000</td> <td>PC</td> </tr> <tr> <td>VM1605A0</td> <td>CLIP TWIST LOCK DIAM. 10.2-12.7 MM</td> <td>1.000</td> <td>PC</td> </tr> <tr> <td>VM2172A0</td> <td>LOCKING CLIP FOR PUMP WITH CIRCUIT</td> <td>1.000</td> <td>PC</td> </tr> </tbody> </table>	Code	Description	Qty	UOM	VL1128A1	D6 BARBED CHECK VALVE	2.000	PC	VM1066A0	SADDLE CLIP FOR CABLES PASSING	3.000	PC	VM1088A0	NYLON CLICK CLAMP D7.9-D9.2	1.000	PC	VM1605A0	CLIP TWIST LOCK DIAM. 10.2-12.7 MM	1.000	PC	VM2172A0	LOCKING CLIP FOR PUMP WITH CIRCUIT	1.000	PC
					Code	Description	Qty	UOM																					
					VL1128A1	D6 BARBED CHECK VALVE	2.000	PC																					
					VM1066A0	SADDLE CLIP FOR CABLES PASSING	3.000	PC																					
					VM1088A0	NYLON CLICK CLAMP D7.9-D9.2	1.000	PC																					
VM1605A0	CLIP TWIST LOCK DIAM. 10.2-12.7 MM	1.000	PC																										
VM2172A0	LOCKING CLIP FOR PUMP WITH CIRCUIT	1.000	PC																										
MR1025A	3 POLES 450V 41A+GROUND TERMINAL BLOCK		KMR1025A	3 POLES TERMINAL BLOCK KIT	<table border="1"> <thead> <tr> <th>Code</th> <th>Description</th> <th>Qty</th> <th>UOM</th> </tr> </thead> <tbody> <tr> <td>MR1025A1</td> <td>3 POLES 450V 41A+GROUND TERMINAL BLOCK</td> <td>1.000</td> <td>PC</td> </tr> </tbody> </table>	Code	Description	Qty	UOM	MR1025A1	3 POLES 450V 41A+GROUND TERMINAL BLOCK	1.000	PC																
					Code	Description	Qty	UOM																					
					MR1025A1	3 POLES 450V 41A+GROUND TERMINAL BLOCK	1.000	PC																					
					PE2115A	BLSP HOOD AND PROVER POWER BOARD		KPE2115A	BLSP HOOD AND PROVER POWER BOARD KIT	<table border="1"> <thead> <tr> <th>Code</th> <th>Description</th> <th>Qty</th> <th>UOM</th> </tr> </thead> <tbody> <tr> <td>PE2115A0</td> <td>BLSP HOOD AND PROVER POWER BOAR</td> <td>1.000</td> <td>PC</td> </tr> <tr> <td>VI1850A0</td> <td>TCB M4x6 SCREW</td> <td>2.000</td> <td>PC</td> </tr> <tr> <td>VM1746A0</td> <td>H10 M4 JOINT BOARD FASTENING CLIP</td> <td>2.000</td> <td>PC</td> </tr> <tr> <td>VM1747A0</td> <td>JOINT-PIN H10 POWER BOARD FASTENING CLIP</td> <td>2.000</td> <td>PC</td> </tr> </tbody> </table>	Code	Description	Qty	UOM	PE2115A0	BLSP HOOD AND PROVER POWER BOAR	1.000	PC	VI1850A0	TCB M4x6 SCREW	2.000	PC	VM1746A0	H10 M4 JOINT BOARD FASTENING CLIP	2.000	PC	VM1747A0	JOINT-PIN H10 POWER BOARD FASTENING CLIP	2.000
Code	Description	Qty	UOM																										
PE2115A0	BLSP HOOD AND PROVER POWER BOAR	1.000	PC																										
VI1850A0	TCB M4x6 SCREW	2.000	PC																										
VM1746A0	H10 M4 JOINT BOARD FASTENING CLIP	2.000	PC																										
VM1747A0	JOINT-PIN H10 POWER BOARD FASTENING CLIP	2.000	PC																										
RS1100A	C.D.T. HEATING ELEMENT 90W 110V		KRS1100A	90W 110V BREAKING ELEMENT KIT	<table border="1"> <thead> <tr> <th>Code</th> <th>Description</th> <th>Qty</th> <th>UOM</th> </tr> </thead> <tbody> <tr> <td>RS1100A0</td> <td>C.D.T. HEATING ELEMENT 90W 110V</td> <td>1.000</td> <td>PC</td> </tr> </tbody> </table>	Code	Description	Qty	UOM	RS1100A0	C.D.T. HEATING ELEMENT 90W 110V	1.000	PC																
Code	Description	Qty	UOM																										
RS1100A0	C.D.T. HEATING ELEMENT 90W 110V	1.000	PC																										

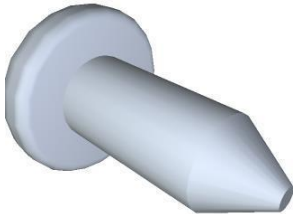

COMPONENT			SPARE PART										
Code	Description	Image	Code	Description	Kit components								
VE1075A	STRAIN RELIEF PA6 UL94V2+ FIXING SCREWS		KVE1075A	PANEL WIRE CLAMP 10PCS KIT	<table border="1"> <thead> <tr> <th>Code</th> <th>Description</th> <th>Qty</th> <th>UOM</th> </tr> </thead> <tbody> <tr> <td>VE1075A0</td> <td>STRAIN RELIEF PA6 UL94V2+ FIXING SCREWS</td> <td>10.000</td> <td>PC</td> </tr> </tbody> </table>	Code	Description	Qty	UOM	VE1075A0	STRAIN RELIEF PA6 UL94V2+ FIXING SCREWS	10.000	PC
Code	Description	Qty	UOM										
VE1075A0	STRAIN RELIEF PA6 UL94V2+ FIXING SCREWS	10.000	PC										
VI1095A	3,9x9,5 SELF-THREADING SCREW		VI1095A0	3,9x9,5 SELF-THREADING SCREW									
VM1745A	CARD SUPPORT		KVM1745A	BOARD SUPPORT 10 PCS KIT	<table border="1"> <thead> <tr> <th>Code</th> <th>Description</th> <th>Qty</th> <th>UOM</th> </tr> </thead> <tbody> <tr> <td>VM1745A0</td> <td>CARD SUPPORT</td> <td>10.000</td> <td>PC</td> </tr> </tbody> </table>	Code	Description	Qty	UOM	VM1745A0	CARD SUPPORT	10.000	PC
Code	Description	Qty	UOM										
VM1745A0	CARD SUPPORT	10.000	PC										