

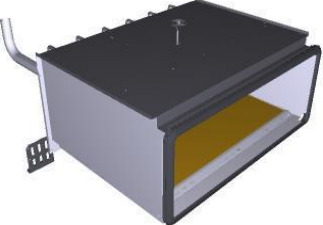





Assembly code	Assembly description	Assembly image
ASM1603A/0.D05	Cooking chamber	
ASM1668A/0.D01	General overview	
ASM3421A/0.D01	Door	
ASM4295A/0.D00	External cover	
ASM4296A/0.D00	Electrical system	

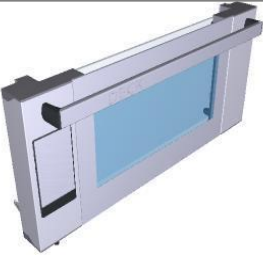

**ASM1603A/0.D05 - Cooking chamber**

**FRONT**

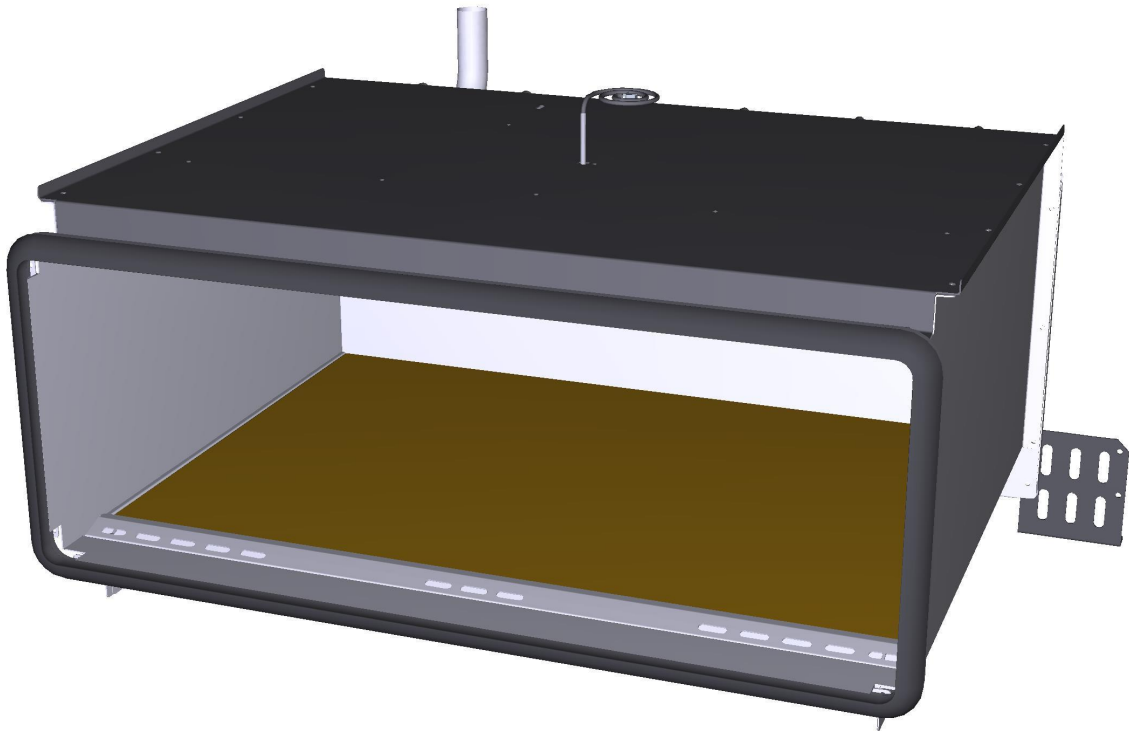



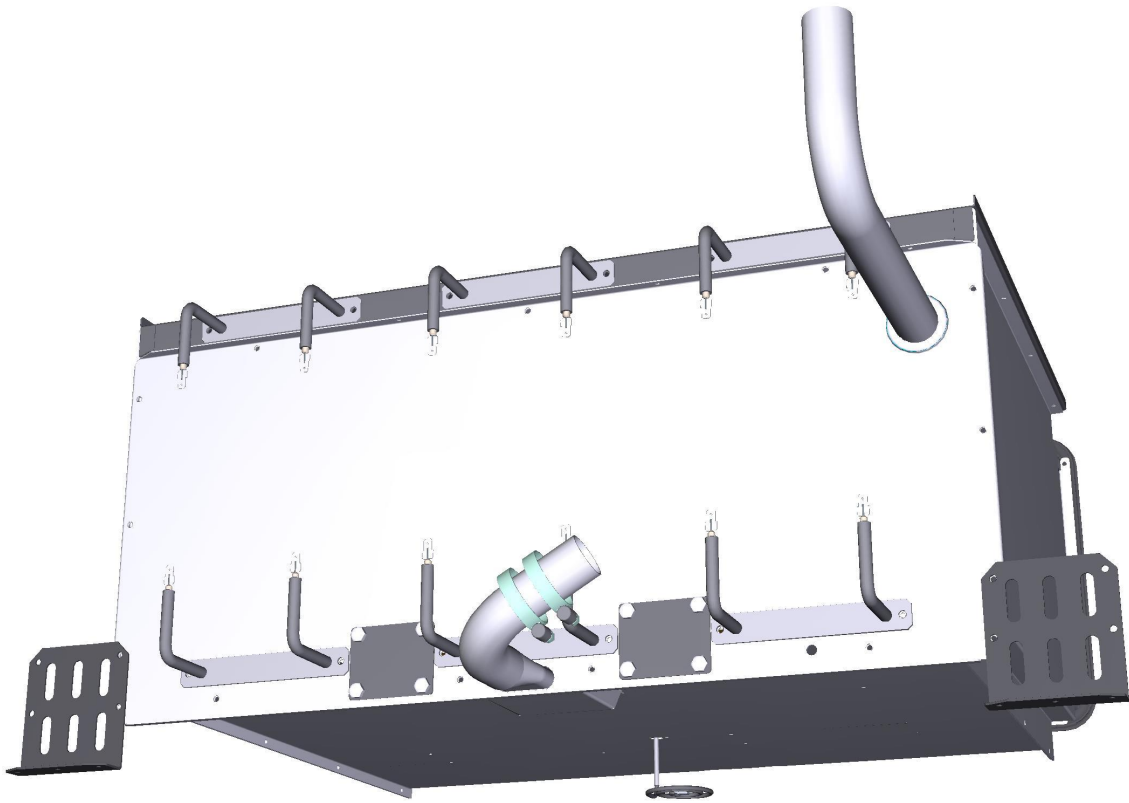

ASM1603A/0.D05 - Cooking chamber

REAR



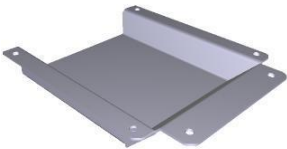



COMPONENT			SPARE PART		
Code	Description	Image	Code	Description	Kit components
0H1568A	DECK OVEN SAFETY THERMOSTAT COVER		0H1568A0	DECK OVEN SAFETY THERMOSTAT COVER	
0H2161A	DECK SP STEAM PIPE COVERING PLATE		0H2161A0	DECK SP STEAM PIPE COVERING PLATE	
0H4820A	BULB HOLDING BRACKET		0H4820A1	BULB HOLDING BRACKET	
0H7167A	L PLATE COMPENSATION FOR DECK STONE		0H7167A0	L PLATE COMPENSATION FOR DECK STONE	
0H6919A	DECK OVEN VENTURI CHAMBER		0H6919A0	DECK OVEN VENTURI CHAMBER	

COMPONENT			SPARE PART																			
Code	Description	Image	Code	Description	Kit components																	
RC1378A	HOSE CLAMP		KVM2379A	MM 200V VENTURI ACTUATOR SYSTEM KIT	<table border="1"> <thead> <tr> <th>Code</th> <th>Description</th> <th>Qty</th> <th>UOM</th> </tr> </thead> <tbody> <tr> <td>RC1378A0</td> <td>HOSE CLAMP</td> <td>3.000</td> <td>PC</td> </tr> <tr> <td>TB1520A0</td> <td>Int. Ø=38 TH=4 DRAIN BLACK RUBBER PIPE</td> <td>0.120</td> <td>M</td> </tr> <tr> <td>VM2379A1</td> <td></td> <td>1.000</td> <td>PC</td> </tr> </tbody> </table>	Code	Description	Qty	UOM	RC1378A0	HOSE CLAMP	3.000	PC	TB1520A0	Int. Ø=38 TH=4 DRAIN BLACK RUBBER PIPE	0.120	M	VM2379A1		1.000	PC	
			Code	Description	Qty	UOM																
			RC1378A0	HOSE CLAMP	3.000	PC																
			TB1520A0	Int. Ø=38 TH=4 DRAIN BLACK RUBBER PIPE	0.120	M																
VM2379A1		1.000	PC																			
KVM2378A	MM 240V VENTURI ACTUATOR SYSTEM KIT	<table border="1"> <thead> <tr> <th>Code</th> <th>Description</th> <th>Qty</th> <th>UOM</th> </tr> </thead> <tbody> <tr> <td>RC1378A0</td> <td>HOSE CLAMP</td> <td>3.000</td> <td>PC</td> </tr> <tr> <td>TB1520A0</td> <td>Int. Ø=38 TH=4 DRAIN BLACK RUBBER PIPE</td> <td>0.120</td> <td>M</td> </tr> <tr> <td>VM2378A1</td> <td></td> <td>1.000</td> <td>PC</td> </tr> </tbody> </table>	Code	Description	Qty	UOM	RC1378A0	HOSE CLAMP	3.000	PC	TB1520A0	Int. Ø=38 TH=4 DRAIN BLACK RUBBER PIPE	0.120	M	VM2378A1		1.000	PC				
Code	Description	Qty	UOM																			
RC1378A0	HOSE CLAMP	3.000	PC																			
TB1520A0	Int. Ø=38 TH=4 DRAIN BLACK RUBBER PIPE	0.120	M																			
VM2378A1		1.000	PC																			
KVM2377A	MM 220 V VENTURI ACTUATOR SYSTEM KIT	<table border="1"> <thead> <tr> <th>Code</th> <th>Description</th> <th>Qty</th> <th>UOM</th> </tr> </thead> <tbody> <tr> <td>RC1378A0</td> <td>HOSE CLAMP</td> <td>3.000</td> <td>PC</td> </tr> <tr> <td>TB1520A0</td> <td>Int. Ø=38 TH=4 DRAIN BLACK RUBBER PIPE</td> <td>0.120</td> <td>M</td> </tr> <tr> <td>VM2377A1</td> <td>220 V 50/60 HZ EUR VENTURI SET</td> <td>1.000</td> <td>PC</td> </tr> </tbody> </table>	Code	Description	Qty	UOM	RC1378A0	HOSE CLAMP	3.000	PC	TB1520A0	Int. Ø=38 TH=4 DRAIN BLACK RUBBER PIPE	0.120	M	VM2377A1	220 V 50/60 HZ EUR VENTURI SET	1.000	PC				
Code	Description	Qty	UOM																			
RC1378A0	HOSE CLAMP	3.000	PC																			
TB1520A0	Int. Ø=38 TH=4 DRAIN BLACK RUBBER PIPE	0.120	M																			
VM2377A1	220 V 50/60 HZ EUR VENTURI SET	1.000	PC																			
KVE1140A	S.5/5E JAPAN VERSION VENTURI COIL KIT	<table border="1"> <thead> <tr> <th>Code</th> <th>Description</th> <th>Qty</th> <th>UOM</th> </tr> </thead> <tbody> <tr> <td>RC1378A0</td> <td>HOSE CLAMP</td> <td>2.000</td> <td>PC</td> </tr> <tr> <td>TB1520A0</td> <td>Int. Ø=38 TH=4 DRAIN BLACK RUBBER PIPE</td> <td>0.050</td> <td>M</td> </tr> <tr> <td>VI1220A1</td> <td>4,2x12 TCB SELF-TAPPIN G SCREW</td> <td>1.000</td> <td>PC</td> </tr> <tr> <td>VM2632A0</td> <td></td> <td>1.000</td> <td>PC</td> </tr> </tbody> </table>	Code	Description	Qty	UOM	RC1378A0	HOSE CLAMP	2.000	PC	TB1520A0	Int. Ø=38 TH=4 DRAIN BLACK RUBBER PIPE	0.050	M	VI1220A1	4,2x12 TCB SELF-TAPPIN G SCREW	1.000	PC	VM2632A0		1.000	PC
Code	Description	Qty	UOM																			
RC1378A0	HOSE CLAMP	2.000	PC																			
TB1520A0	Int. Ø=38 TH=4 DRAIN BLACK RUBBER PIPE	0.050	M																			
VI1220A1	4,2x12 TCB SELF-TAPPIN G SCREW	1.000	PC																			
VM2632A0		1.000	PC																			
GN1120A	NTC TEMPERATURE PROBE SEAL		KVE1014A	US VERSION SERIES 5 VENTURI COIL KIT	<table border="1"> <thead> <tr> <th>Code</th> <th>Description</th> <th>Qty</th> <th>UOM</th> </tr> </thead> <tbody> <tr> <td>RC1378A0</td> <td>HOSE CLAMP</td> <td>2.000</td> <td>PC</td> </tr> <tr> <td>TB1520A0</td> <td>Int. Ø=38 TH=4 DRAIN BLACK RUBBER PIPE</td> <td>0.050</td> <td>M</td> </tr> <tr> <td>VM2633A0</td> <td></td> <td>1.000</td> <td>PC</td> </tr> </tbody> </table>	Code	Description	Qty	UOM	RC1378A0	HOSE CLAMP	2.000	PC	TB1520A0	Int. Ø=38 TH=4 DRAIN BLACK RUBBER PIPE	0.050	M	VM2633A0		1.000	PC	
			Code	Description	Qty	UOM																
			RC1378A0	HOSE CLAMP	2.000	PC																
TB1520A0	Int. Ø=38 TH=4 DRAIN BLACK RUBBER PIPE	0.050	M																			
VM2633A0		1.000	PC																			
KRC1378A	HOSE CLAMP 10 PCS KIT	<table border="1"> <thead> <tr> <th>Code</th> <th>Description</th> <th>Qty</th> <th>UOM</th> </tr> </thead> <tbody> <tr> <td>RC1378A0</td> <td>HOSE CLAMP</td> <td>10.000</td> <td>PC</td> </tr> </tbody> </table>	Code	Description	Qty	UOM	RC1378A0	HOSE CLAMP	10.000	PC												
Code	Description	Qty	UOM																			
RC1378A0	HOSE CLAMP	10.000	PC																			
KTR1106A	5-5E S. L2000 CHAMBER TEMP. PROBE KIT	<table border="1"> <thead> <tr> <th>Code</th> <th>Description</th> <th>Qty</th> <th>UOM</th> </tr> </thead> <tbody> <tr> <td>GN1285A0</td> <td>NTC TEMPERATUR E PROBE SEALING</td> <td>1.000</td> <td>PC</td> </tr> <tr> <td>SL1045A0</td> <td>S57 BLACK SILICONE - 80ml CARTRIDGE</td> <td>1.000</td> <td>PC</td> </tr> </tbody> </table>	Code	Description	Qty	UOM	GN1285A0	NTC TEMPERATUR E PROBE SEALING	1.000	PC	SL1045A0	S57 BLACK SILICONE - 80ml CARTRIDGE	1.000	PC								
Code	Description	Qty	UOM																			
GN1285A0	NTC TEMPERATUR E PROBE SEALING	1.000	PC																			
SL1045A0	S57 BLACK SILICONE - 80ml CARTRIDGE	1.000	PC																			

COMPONENT			SPARE PART																											
Code	Description	Image	Code	Description	Kit components																									
GN1120A	NTC TEMPERATURE PROBE SEAL		KTR1106A	5-5E S. L2000 CHAMBER TEMP. PROBE KIT	<table border="1"> <thead> <tr> <th>Code</th> <th>Description</th> <th>Qty</th> <th>UOM</th> </tr> </thead> <tbody> <tr> <td>TR1106A3</td> <td>PT100 L=2000 TEMPERATUR E PROBE</td> <td>1.000</td> <td>PC</td> </tr> <tr> <td>VI1220A1</td> <td>4,2x12 TCB SELF-TAPPIN G SCREW</td> <td>2.000</td> <td>PC</td> </tr> <tr> <td>VM1465A1</td> <td>CT BT TEMPERATUR E PROBE COVER</td> <td>1.000</td> <td>PC</td> </tr> </tbody> </table>	Code	Description	Qty	UOM	TR1106A3	PT100 L=2000 TEMPERATUR E PROBE	1.000	PC	VI1220A1	4,2x12 TCB SELF-TAPPIN G SCREW	2.000	PC	VM1465A1	CT BT TEMPERATUR E PROBE COVER	1.000	PC									
			Code	Description	Qty	UOM																								
			TR1106A3	PT100 L=2000 TEMPERATUR E PROBE	1.000	PC																								
VI1220A1	4,2x12 TCB SELF-TAPPIN G SCREW	2.000	PC																											
VM1465A1	CT BT TEMPERATUR E PROBE COVER	1.000	PC																											
KTR1096A	NTC 150 L=1500 TEMPERATURE PROBE KIT	<table border="1"> <thead> <tr> <th>Code</th> <th>Description</th> <th>Qty</th> <th>UOM</th> </tr> </thead> <tbody> <tr> <td>GN1120A1</td> <td>NTC TEMPERATUR E PROBE SEAL</td> <td>1.000</td> <td>PC</td> </tr> <tr> <td>GN1285A0</td> <td>NTC TEMPERATUR E PROBE SEALING</td> <td>2.000</td> <td>PC</td> </tr> <tr> <td>SL1045A0</td> <td>S57 BLACK SILICONE - 80ml CARTRIDGE</td> <td>1.000</td> <td>PC</td> </tr> <tr> <td>TR1096A0</td> <td>TEMPERATUR E PROBE NTC 150 L=1500</td> <td>1.000</td> <td>PC</td> </tr> <tr> <td>VI1220A1</td> <td>4,2x12 TCB SELF-TAPPIN G SCREW</td> <td>2.000</td> <td>PC</td> </tr> <tr> <td>VM1465A1</td> <td>CT BT TEMPERATUR E PROBE COVER</td> <td>1.000</td> <td>PC</td> </tr> </tbody> </table>	Code	Description	Qty	UOM	GN1120A1	NTC TEMPERATUR E PROBE SEAL	1.000	PC	GN1285A0	NTC TEMPERATUR E PROBE SEALING	2.000	PC	SL1045A0	S57 BLACK SILICONE - 80ml CARTRIDGE	1.000	PC	TR1096A0	TEMPERATUR E PROBE NTC 150 L=1500	1.000	PC	VI1220A1	4,2x12 TCB SELF-TAPPIN G SCREW	2.000	PC	VM1465A1	CT BT TEMPERATUR E PROBE COVER	1.000	PC
Code	Description	Qty	UOM																											
GN1120A1	NTC TEMPERATUR E PROBE SEAL	1.000	PC																											
GN1285A0	NTC TEMPERATUR E PROBE SEALING	2.000	PC																											
SL1045A0	S57 BLACK SILICONE - 80ml CARTRIDGE	1.000	PC																											
TR1096A0	TEMPERATUR E PROBE NTC 150 L=1500	1.000	PC																											
VI1220A1	4,2x12 TCB SELF-TAPPIN G SCREW	2.000	PC																											
VM1465A1	CT BT TEMPERATUR E PROBE COVER	1.000	PC																											
KTR1095A	NTC 150 L=1050 TEMPERATURE PROBE KIT	<table border="1"> <thead> <tr> <th>Code</th> <th>Description</th> <th>Qty</th> <th>UOM</th> </tr> </thead> <tbody> <tr> <td>GN1120A1</td> <td>NTC TEMPERATUR E PROBE SEAL</td> <td>1.000</td> <td>PC</td> </tr> <tr> <td>GN1285A0</td> <td>NTC TEMPERATUR E PROBE SEALING</td> <td>1.000</td> <td>PC</td> </tr> <tr> <td>SL1045A0</td> <td>S57 BLACK SILICONE - 80ml CARTRIDGE</td> <td>1.000</td> <td>PC</td> </tr> <tr> <td>TR1095A0</td> <td>TEMPERATUR E PROBE NTC 150 L=1050</td> <td>1.000</td> <td>PC</td> </tr> <tr> <td>VI1220A1</td> <td>4,2x12 TCB SELF-TAPPIN G SCREW</td> <td>2.000</td> <td>PC</td> </tr> <tr> <td>VM1465A1</td> <td>CT BT TEMPERATUR E PROBE COVER</td> <td>1.000</td> <td>PC</td> </tr> </tbody> </table>	Code	Description	Qty	UOM	GN1120A1	NTC TEMPERATUR E PROBE SEAL	1.000	PC	GN1285A0	NTC TEMPERATUR E PROBE SEALING	1.000	PC	SL1045A0	S57 BLACK SILICONE - 80ml CARTRIDGE	1.000	PC	TR1095A0	TEMPERATUR E PROBE NTC 150 L=1050	1.000	PC	VI1220A1	4,2x12 TCB SELF-TAPPIN G SCREW	2.000	PC	VM1465A1	CT BT TEMPERATUR E PROBE COVER	1.000	PC
Code	Description	Qty	UOM																											
GN1120A1	NTC TEMPERATUR E PROBE SEAL	1.000	PC																											
GN1285A0	NTC TEMPERATUR E PROBE SEALING	1.000	PC																											
SL1045A0	S57 BLACK SILICONE - 80ml CARTRIDGE	1.000	PC																											
TR1095A0	TEMPERATUR E PROBE NTC 150 L=1050	1.000	PC																											
VI1220A1	4,2x12 TCB SELF-TAPPIN G SCREW	2.000	PC																											
VM1465A1	CT BT TEMPERATUR E PROBE COVER	1.000	PC																											



COMPONENT			SPARE PART																										
Code	Description	Image	Code	Description	Kit components																								
TR1150B	CL.A L1200 46L2 PT1000 TEMPERATURE PROBE		KTR1150B	PT1000 L1200 TEMPERATURE PROBE KIT	<table border="1"> <thead> <tr> <th>Code</th> <th>Description</th> <th>Qty</th> <th>UOM</th> </tr> </thead> <tbody> <tr> <td>GN1285A0</td> <td>NTC TEMPERATUR E PROBE SEALING</td> <td>1.000</td> <td>PC</td> </tr> <tr> <td>TR1150B1</td> <td>CL.A L1200 46L2 PT1000 TEMPERATUR E PROBE</td> <td>1.000</td> <td>PC</td> </tr> <tr> <td>VI1220A1</td> <td>4,2x12 TCB SELF-TAPPIN G SCREW</td> <td>1.000</td> <td>PC</td> </tr> <tr> <td>VM1465A1</td> <td>CT BT TEMPERATUR E PROBE COVER</td> <td>1.000</td> <td>PC</td> </tr> </tbody> </table>	Code	Description	Qty	UOM	GN1285A0	NTC TEMPERATUR E PROBE SEALING	1.000	PC	TR1150B1	CL.A L1200 46L2 PT1000 TEMPERATUR E PROBE	1.000	PC	VI1220A1	4,2x12 TCB SELF-TAPPIN G SCREW	1.000	PC	VM1465A1	CT BT TEMPERATUR E PROBE COVER	1.000	PC				
Code	Description	Qty	UOM																										
GN1285A0	NTC TEMPERATUR E PROBE SEALING	1.000	PC																										
TR1150B1	CL.A L1200 46L2 PT1000 TEMPERATUR E PROBE	1.000	PC																										
VI1220A1	4,2x12 TCB SELF-TAPPIN G SCREW	1.000	PC																										
VM1465A1	CT BT TEMPERATUR E PROBE COVER	1.000	PC																										
GN1514A	XB264 DOOR GASKET 1676MM		KG1514A	XB262-264 DOOR GASKET KIT	<table border="1"> <thead> <tr> <th>Code</th> <th>Description</th> <th>Qty</th> <th>UOM</th> </tr> </thead> <tbody> <tr> <td>GN1110A2</td> <td>Line Miss/XVC105-0 55/XK/XL DOOR GASKE</td> <td>1.680</td> <td>M</td> </tr> </tbody> </table>	Code	Description	Qty	UOM	GN1110A2	Line Miss/XVC105-0 55/XK/XL DOOR GASKE	1.680	M																
Code	Description	Qty	UOM																										
GN1110A2	Line Miss/XVC105-0 55/XK/XL DOOR GASKE	1.680	M																										
IE3421A	IE3421A0		IE3421A0	IE3421A0																									
RS1273A	450W 77V 1 TURN FLAT ELEMENT		KRS1273A	XB262E FLAT HEATING ELEMENT KIT	<table border="1"> <thead> <tr> <th>Code</th> <th>Description</th> <th>Qty</th> <th>UOM</th> </tr> </thead> <tbody> <tr> <td>RS1273A0</td> <td>450W 77V 1 TURN FLAT ELEMENT</td> <td>1.000</td> <td>PC</td> </tr> <tr> <td>SL1045A0</td> <td>S57 BLACK SILICONE - 80ml CARTRIDGE</td> <td>1.000</td> <td>PC</td> </tr> <tr> <td>VI1220A1</td> <td>4,2x12 TCB SELF-TAPPIN G SCREW</td> <td>2.000</td> <td>PC</td> </tr> <tr> <td>VM1794A0</td> <td>250x4.8 PA66 BLACK CLAMP</td> <td>2.000</td> <td>PC</td> </tr> <tr> <td>VM2103A0</td> <td>CLAMP LOCK</td> <td>2.000</td> <td>PC</td> </tr> </tbody> </table>	Code	Description	Qty	UOM	RS1273A0	450W 77V 1 TURN FLAT ELEMENT	1.000	PC	SL1045A0	S57 BLACK SILICONE - 80ml CARTRIDGE	1.000	PC	VI1220A1	4,2x12 TCB SELF-TAPPIN G SCREW	2.000	PC	VM1794A0	250x4.8 PA66 BLACK CLAMP	2.000	PC	VM2103A0	CLAMP LOCK	2.000	PC
Code	Description	Qty	UOM																										
RS1273A0	450W 77V 1 TURN FLAT ELEMENT	1.000	PC																										
SL1045A0	S57 BLACK SILICONE - 80ml CARTRIDGE	1.000	PC																										
VI1220A1	4,2x12 TCB SELF-TAPPIN G SCREW	2.000	PC																										
VM1794A0	250x4.8 PA66 BLACK CLAMP	2.000	PC																										
VM2103A0	CLAMP LOCK	2.000	PC																										



**ASM1668A/0.D01 - General overview**

**FRONT**

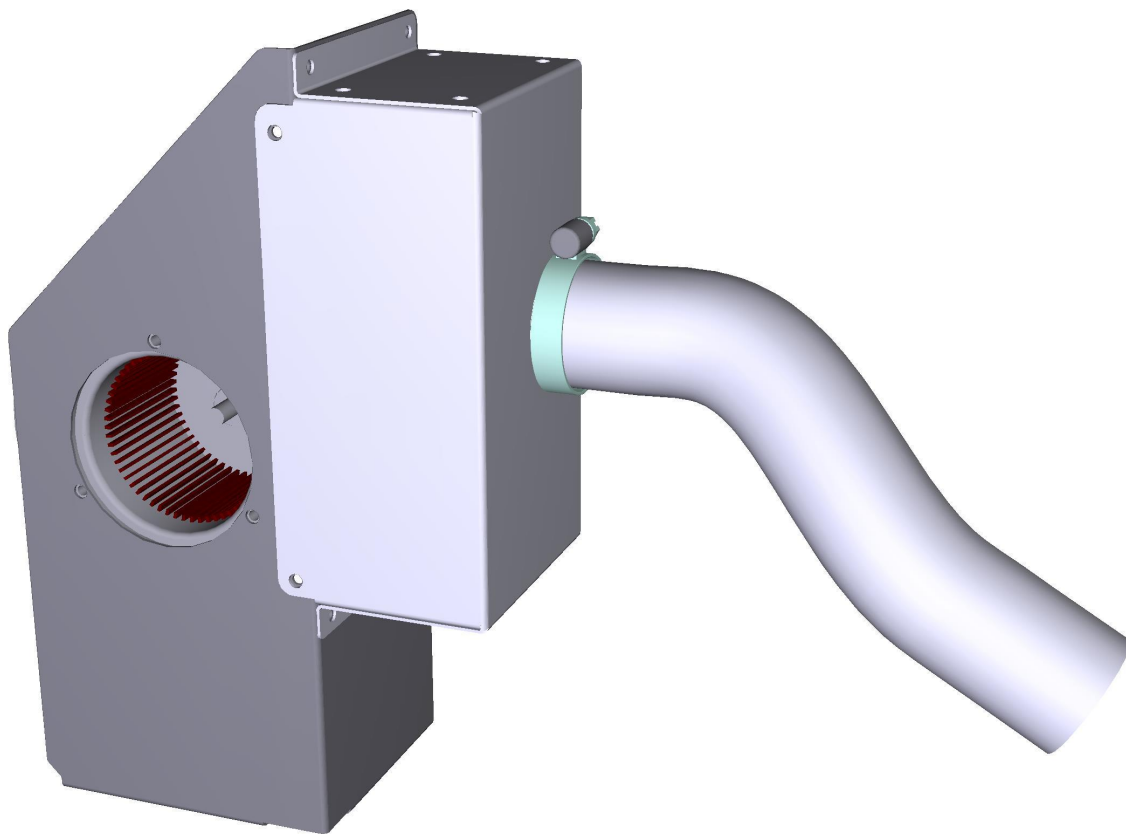





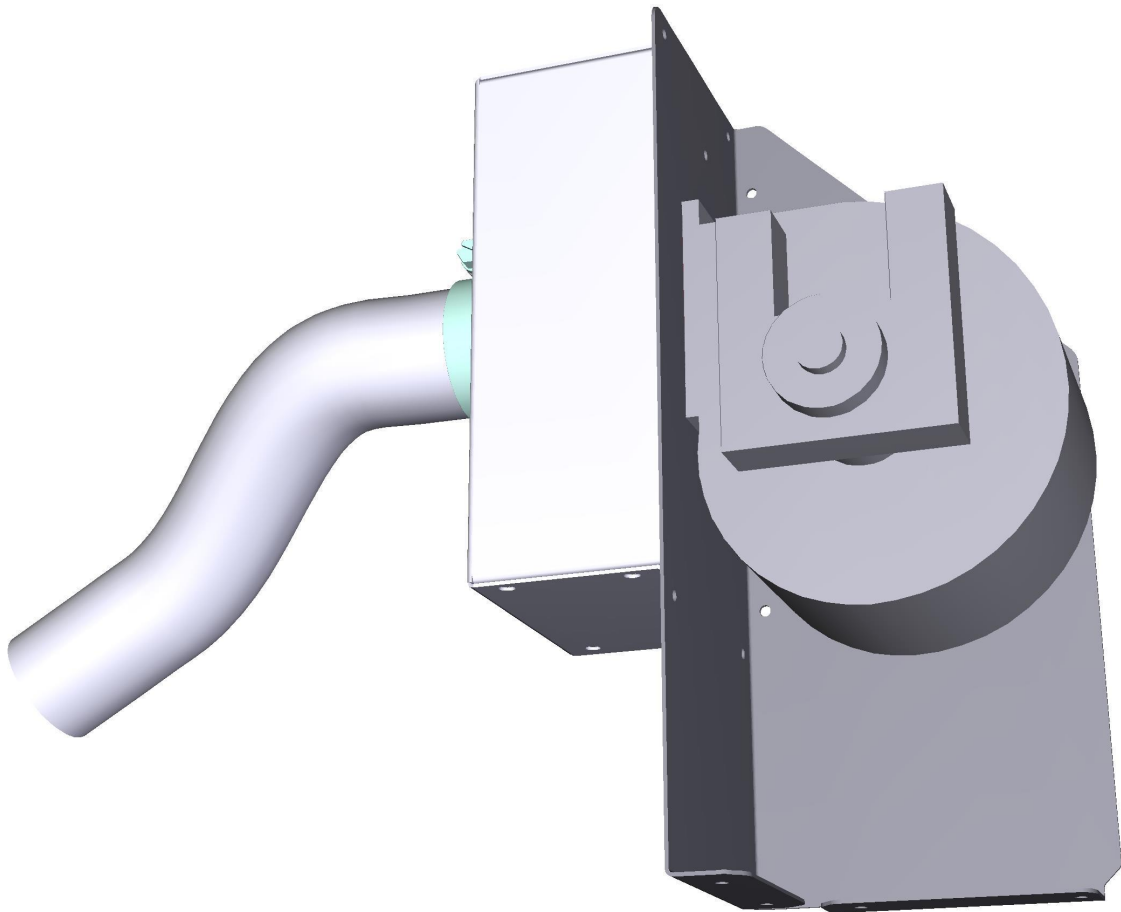

**ASM1668A/0.D01 - General overview**

**REAR**



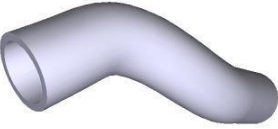

COMPONENT			SPARE PART										
Code	Description	Image	Code	Description	Kit components								
0H6620A	DECKTOP FAN HOLDER		0H6620A0	DECKTOP FAN HOLDER									
0H6621A	XB262 DECK OVEN FAN BOX		0H6621A0	XB262 DECK OVEN FAN BOX									
0H6622A	XB262 DECK OVEN FLAP PRESS		0H6622A0	XB262 DECK OVEN FLAP PRESS									
GN1419A	DECK OVEN VENTURI FLAP		GN1419A0	DECK OVEN VENTURI FLAP									
MT1015A	DECK TOP CENTRIFUGAL FAN		KMT1015A	DECK OVEN FAN MOTOR KIT	<table border="1"> <thead> <tr> <th>Code</th> <th>Description</th> <th>Qty</th> <th>UOM</th> </tr> </thead> <tbody> <tr> <td>MT1015A1</td> <td>DECK OVEN CENTRIFUGAL FAN</td> <td>1.000</td> <td>PC</td> </tr> </tbody> </table>	Code	Description	Qty	UOM	MT1015A1	DECK OVEN CENTRIFUGAL FAN	1.000	PC
Code	Description	Qty	UOM										
MT1015A1	DECK OVEN CENTRIFUGAL FAN	1.000	PC										

COMPONENT			SPARE PART																			
Code	Description	Image	Code	Description	Kit components																	
RC1378A	HOSE CLAMP		KVM2379A	MM 200V VENTURI ACTUATOR SYSTEM KIT	<table border="1"> <thead> <tr> <th>Code</th> <th>Description</th> <th>Qty</th> <th>UOM</th> </tr> </thead> <tbody> <tr> <td>RC1378A0</td> <td>HOSE CLAMP</td> <td>3.000</td> <td>PC</td> </tr> <tr> <td>TB1520A0</td> <td>Int. Ø=38 TH=4 DRAIN BLACK RUBBER PIPE</td> <td>0.120</td> <td>M</td> </tr> <tr> <td>VM2379A1</td> <td></td> <td>1.000</td> <td>PC</td> </tr> </tbody> </table>	Code	Description	Qty	UOM	RC1378A0	HOSE CLAMP	3.000	PC	TB1520A0	Int. Ø=38 TH=4 DRAIN BLACK RUBBER PIPE	0.120	M	VM2379A1		1.000	PC	
			Code	Description	Qty	UOM																
			RC1378A0	HOSE CLAMP	3.000	PC																
			TB1520A0	Int. Ø=38 TH=4 DRAIN BLACK RUBBER PIPE	0.120	M																
			VM2379A1		1.000	PC																
KVM2378A	MM 240V VENTURI ACTUATOR SYSTEM KIT	<table border="1"> <thead> <tr> <th>Code</th> <th>Description</th> <th>Qty</th> <th>UOM</th> </tr> </thead> <tbody> <tr> <td>RC1378A0</td> <td>HOSE CLAMP</td> <td>3.000</td> <td>PC</td> </tr> <tr> <td>TB1520A0</td> <td>Int. Ø=38 TH=4 DRAIN BLACK RUBBER PIPE</td> <td>0.120</td> <td>M</td> </tr> <tr> <td>VM2378A1</td> <td></td> <td>1.000</td> <td>PC</td> </tr> </tbody> </table>	Code	Description	Qty	UOM	RC1378A0	HOSE CLAMP	3.000	PC	TB1520A0	Int. Ø=38 TH=4 DRAIN BLACK RUBBER PIPE	0.120	M	VM2378A1		1.000	PC				
Code	Description	Qty	UOM																			
RC1378A0	HOSE CLAMP	3.000	PC																			
TB1520A0	Int. Ø=38 TH=4 DRAIN BLACK RUBBER PIPE	0.120	M																			
VM2378A1		1.000	PC																			
KVM2377A	MM 220 V VENTURI ACTUATOR SYSTEM KIT	<table border="1"> <thead> <tr> <th>Code</th> <th>Description</th> <th>Qty</th> <th>UOM</th> </tr> </thead> <tbody> <tr> <td>RC1378A0</td> <td>HOSE CLAMP</td> <td>3.000</td> <td>PC</td> </tr> <tr> <td>TB1520A0</td> <td>Int. Ø=38 TH=4 DRAIN BLACK RUBBER PIPE</td> <td>0.120</td> <td>M</td> </tr> <tr> <td>VM2377A1</td> <td>220 V 50/60 HZ EUR VENTURI SET</td> <td>1.000</td> <td>PC</td> </tr> </tbody> </table>	Code	Description	Qty	UOM	RC1378A0	HOSE CLAMP	3.000	PC	TB1520A0	Int. Ø=38 TH=4 DRAIN BLACK RUBBER PIPE	0.120	M	VM2377A1	220 V 50/60 HZ EUR VENTURI SET	1.000	PC				
Code	Description	Qty	UOM																			
RC1378A0	HOSE CLAMP	3.000	PC																			
TB1520A0	Int. Ø=38 TH=4 DRAIN BLACK RUBBER PIPE	0.120	M																			
VM2377A1	220 V 50/60 HZ EUR VENTURI SET	1.000	PC																			
KVE1140A	S.5/5E JAPAN VERSION VENTURI COIL KIT	<table border="1"> <thead> <tr> <th>Code</th> <th>Description</th> <th>Qty</th> <th>UOM</th> </tr> </thead> <tbody> <tr> <td>RC1378A0</td> <td>HOSE CLAMP</td> <td>2.000</td> <td>PC</td> </tr> <tr> <td>TB1520A0</td> <td>Int. Ø=38 TH=4 DRAIN BLACK RUBBER PIPE</td> <td>0.050</td> <td>M</td> </tr> <tr> <td>VI1220A1</td> <td>4,2x12 TCB SELF-TAPPIN G SCREW</td> <td>1.000</td> <td>PC</td> </tr> <tr> <td>VM2632A0</td> <td></td> <td>1.000</td> <td>PC</td> </tr> </tbody> </table>	Code	Description	Qty	UOM	RC1378A0	HOSE CLAMP	2.000	PC	TB1520A0	Int. Ø=38 TH=4 DRAIN BLACK RUBBER PIPE	0.050	M	VI1220A1	4,2x12 TCB SELF-TAPPIN G SCREW	1.000	PC	VM2632A0		1.000	PC
Code	Description	Qty	UOM																			
RC1378A0	HOSE CLAMP	2.000	PC																			
TB1520A0	Int. Ø=38 TH=4 DRAIN BLACK RUBBER PIPE	0.050	M																			
VI1220A1	4,2x12 TCB SELF-TAPPIN G SCREW	1.000	PC																			
VM2632A0		1.000	PC																			
KVE1014A	US VERSION SERIES 5 VENTURI COIL KIT	<table border="1"> <thead> <tr> <th>Code</th> <th>Description</th> <th>Qty</th> <th>UOM</th> </tr> </thead> <tbody> <tr> <td>RC1378A0</td> <td>HOSE CLAMP</td> <td>2.000</td> <td>PC</td> </tr> <tr> <td>TB1520A0</td> <td>Int. Ø=38 TH=4 DRAIN BLACK RUBBER PIPE</td> <td>0.050</td> <td>M</td> </tr> <tr> <td>VM2633A0</td> <td></td> <td>1.000</td> <td>PC</td> </tr> </tbody> </table>	Code	Description	Qty	UOM	RC1378A0	HOSE CLAMP	2.000	PC	TB1520A0	Int. Ø=38 TH=4 DRAIN BLACK RUBBER PIPE	0.050	M	VM2633A0		1.000	PC				
Code	Description	Qty	UOM																			
RC1378A0	HOSE CLAMP	2.000	PC																			
TB1520A0	Int. Ø=38 TH=4 DRAIN BLACK RUBBER PIPE	0.050	M																			
VM2633A0		1.000	PC																			
KRC1378A	HOSE CLAMP 10 PCS KIT	<table border="1"> <thead> <tr> <th>Code</th> <th>Description</th> <th>Qty</th> <th>UOM</th> </tr> </thead> <tbody> <tr> <td>RC1378A0</td> <td>HOSE CLAMP</td> <td>10.000</td> <td>PC</td> </tr> </tbody> </table>	Code	Description	Qty	UOM	RC1378A0	HOSE CLAMP	10.000	PC												
Code	Description	Qty	UOM																			
RC1378A0	HOSE CLAMP	10.000	PC																			
TB3371A	TB3371A0		TB3371A0	TB3371A0																		

ASM3421A/0.D01 - Door

FRONT

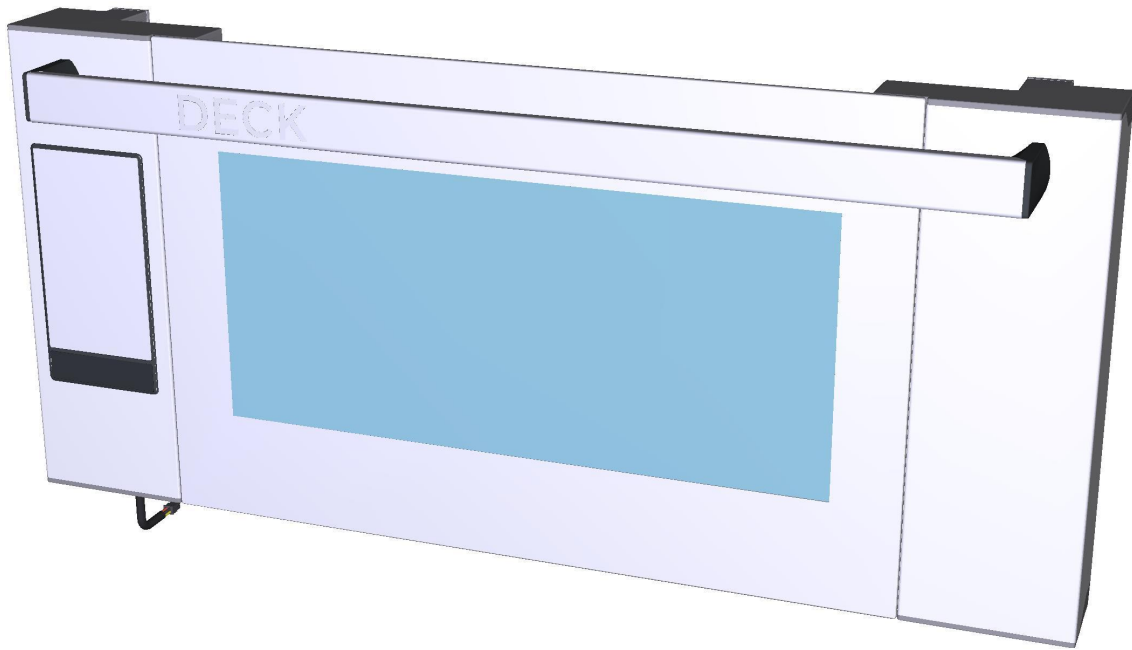



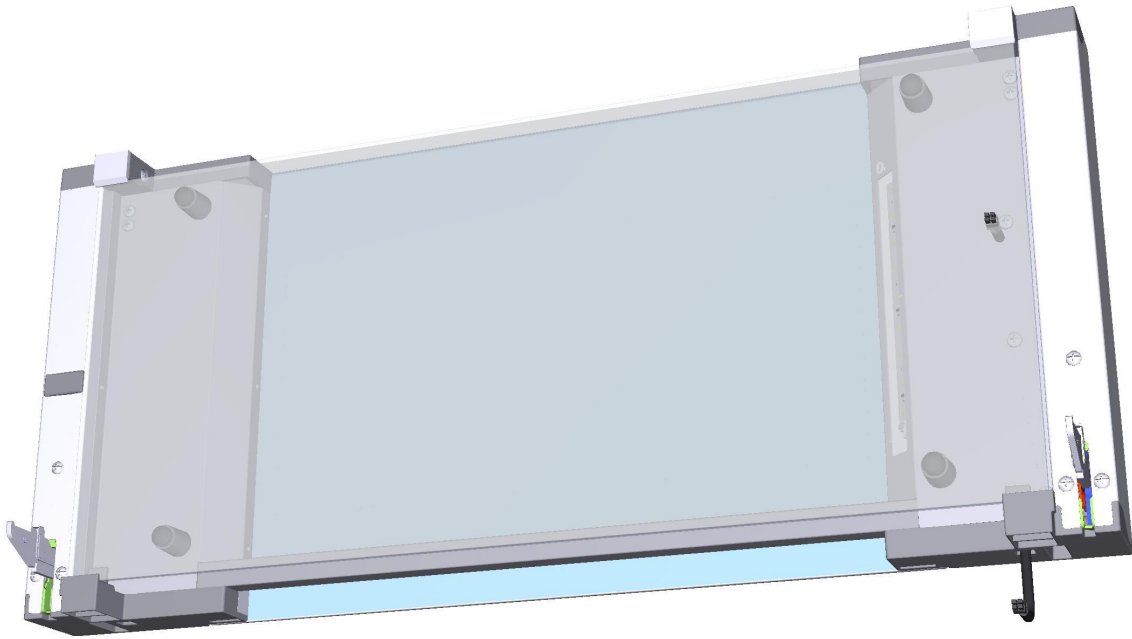

ASM3421A/0.D01 - Door



REAR





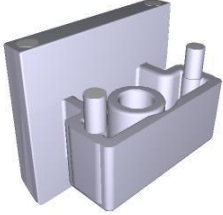

COMPONENT			SPARE PART																						
Code	Description	Image	Code	Description	Kit components																				
OB1286A	OB1286A0		OB1286A0	OB1286A0																					
OB1288A	OB1288A0		OB1288A0	OB1288A0																					
LP1050A	BL SHOP.PRO L180 COMPLETE LED BA		KLP1050A	L180 COMPLETE LED LIGHT BAR KIT	<table border="1"> <thead> <tr> <th>Code</th> <th>Description</th> <th>Qty</th> <th>UOM</th> </tr> </thead> <tbody> <tr> <td>LP1050A0</td> <td>BL SHOP.PRO L180 COMPLETE LED BAR</td> <td>1.000</td> <td>PC</td> </tr> <tr> <td>VI1014A0</td> <td>STAINLESS STEEL WASHER 4.5X9X0.8</td> <td>1.000</td> <td>PC</td> </tr> <tr> <td>VI1220A1</td> <td>4,2x12 TCB SELF-TAPPING SCREW</td> <td>1.000</td> <td>PC</td> </tr> </tbody> </table>	Code	Description	Qty	UOM	LP1050A0	BL SHOP.PRO L180 COMPLETE LED BAR	1.000	PC	VI1014A0	STAINLESS STEEL WASHER 4.5X9X0.8	1.000	PC	VI1220A1	4,2x12 TCB SELF-TAPPING SCREW	1.000	PC				
Code	Description	Qty	UOM																						
LP1050A0	BL SHOP.PRO L180 COMPLETE LED BAR	1.000	PC																						
VI1014A0	STAINLESS STEEL WASHER 4.5X9X0.8	1.000	PC																						
VI1220A1	4,2x12 TCB SELF-TAPPING SCREW	1.000	PC																						
TB3370A	DROP-DOWN DECK SP HANDLE TUBE		TB3370A0	DROP-DOWN DECK SP HANDLE TUBE																					
VM2456A	BAKERLUX SHOP.PRO HANDLE END		KVM2456A	2 PCS BAKERLUX SHOP.PRO HANDLE END KIT	<table border="1"> <thead> <tr> <th>Code</th> <th>Description</th> <th>Qty</th> <th>UOM</th> </tr> </thead> <tbody> <tr> <td>VI1147A0</td> <td>5X25 STAINLESS STEEL SCREW</td> <td>4.000</td> <td>PC</td> </tr> <tr> <td>VM2456A0</td> <td>BAKERLUX SHOP.PRO HANDLE END</td> <td>1.000</td> <td>PC</td> </tr> <tr> <td>VM2489A0</td> <td>SP HANDLE END KIT + STYLUS KIT</td> <td>1.000</td> <td>PC</td> </tr> <tr> <td>VM2527A0</td> <td>STYLUS PEN FOR SP</td> <td>1.000</td> <td>PC</td> </tr> </tbody> </table>	Code	Description	Qty	UOM	VI1147A0	5X25 STAINLESS STEEL SCREW	4.000	PC	VM2456A0	BAKERLUX SHOP.PRO HANDLE END	1.000	PC	VM2489A0	SP HANDLE END KIT + STYLUS KIT	1.000	PC	VM2527A0	STYLUS PEN FOR SP	1.000	PC
Code	Description	Qty	UOM																						
VI1147A0	5X25 STAINLESS STEEL SCREW	4.000	PC																						
VM2456A0	BAKERLUX SHOP.PRO HANDLE END	1.000	PC																						
VM2489A0	SP HANDLE END KIT + STYLUS KIT	1.000	PC																						
VM2527A0	STYLUS PEN FOR SP	1.000	PC																						



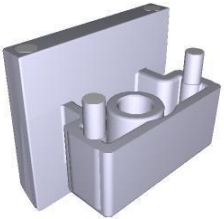

COMPONENT			SPARE PART																		
Code	Description	Image	Code	Description	Kit components																
VM2471A	BL SP LOWER CLAMP INT LOCK GLASS SLIDER		KVM2471A	BL SP INTERNAL GLASS LOCK HOLDER KIT	<table border="1"> <thead> <tr> <th>Code</th> <th>Description</th> <th>Qty</th> <th>UOM</th> </tr> </thead> <tbody> <tr> <td>VI1998A0</td> <td>ZINC PLATED SCREW 5X30 TCB</td> <td>2.000</td> <td>PC</td> </tr> <tr> <td>VM2471A0</td> <td>BL SP LOWER CLAMP INT LOCK GLASS SLIDER</td> <td>1.000</td> <td>PC</td> </tr> <tr> <td>VM2472A0</td> <td>BL SP UPPER CLAMP INT LOCK GLASS SLIDER</td> <td>1.000</td> <td>PC</td> </tr> </tbody> </table>	Code	Description	Qty	UOM	VI1998A0	ZINC PLATED SCREW 5X30 TCB	2.000	PC	VM2471A0	BL SP LOWER CLAMP INT LOCK GLASS SLIDER	1.000	PC	VM2472A0	BL SP UPPER CLAMP INT LOCK GLASS SLIDER	1.000	PC
					Code	Description	Qty	UOM													
					VI1998A0	ZINC PLATED SCREW 5X30 TCB	2.000	PC													
VM2471A0	BL SP LOWER CLAMP INT LOCK GLASS SLIDER	1.000	PC																		
VM2472A0	BL SP UPPER CLAMP INT LOCK GLASS SLIDER	1.000	PC																		
<table border="1"> <thead> <tr> <th>Code</th> <th>Description</th> <th>Qty</th> <th>UOM</th> </tr> </thead> <tbody> <tr> <td>VM2503A0</td> <td>SLIDE TO FIX INTERNAL NON REMOV GLASS SP</td> <td>2.000</td> <td>PC</td> </tr> </tbody> </table>	Code	Description	Qty	UOM	VM2503A0	SLIDE TO FIX INTERNAL NON REMOV GLASS SP	2.000	PC													
Code	Description	Qty	UOM																		
VM2503A0	SLIDE TO FIX INTERNAL NON REMOV GLASS SP	2.000	PC																		
<table border="1"> <thead> <tr> <th>Code</th> <th>Description</th> <th>Qty</th> <th>UOM</th> </tr> </thead> <tbody> <tr> <td>VM2464A0</td> <td>SHOP.PRO LEFT UPPER CAP DROP DOWN DOOR</td> <td>1.000</td> <td>PC</td> </tr> </tbody> </table>	Code	Description	Qty	UOM	VM2464A0	SHOP.PRO LEFT UPPER CAP DROP DOWN DOOR	1.000	PC													
Code	Description	Qty	UOM																		
VM2464A0	SHOP.PRO LEFT UPPER CAP DROP DOWN DOOR	1.000	PC																		
VM2503A	SLIDE TO FIX INTERNAL NON REMOV GLASS SP		KVM2503A	BL SP INT FIXED GLASS LOCK 2 PCS KIT	<table border="1"> <thead> <tr> <th>Code</th> <th>Description</th> <th>Qty</th> <th>UOM</th> </tr> </thead> <tbody> <tr> <td>VM2503A0</td> <td>SLIDE TO FIX INTERNAL NON REMOV GLASS SP</td> <td>2.000</td> <td>PC</td> </tr> </tbody> </table>	Code	Description	Qty	UOM	VM2503A0	SLIDE TO FIX INTERNAL NON REMOV GLASS SP	2.000	PC								
Code	Description	Qty	UOM																		
VM2503A0	SLIDE TO FIX INTERNAL NON REMOV GLASS SP	2.000	PC																		
VM2464A	SHOP.PRO LEFT UPPER CAP DROP DOWN DOOR		KVM2464A	BL SP LEFT UPPER DROPDOWN DOOR CAP KIT	<table border="1"> <thead> <tr> <th>Code</th> <th>Description</th> <th>Qty</th> <th>UOM</th> </tr> </thead> <tbody> <tr> <td>VM2464A0</td> <td>SHOP.PRO LEFT UPPER CAP DROP DOWN DOOR</td> <td>1.000</td> <td>PC</td> </tr> </tbody> </table>	Code	Description	Qty	UOM	VM2464A0	SHOP.PRO LEFT UPPER CAP DROP DOWN DOOR	1.000	PC								
Code	Description	Qty	UOM																		
VM2464A0	SHOP.PRO LEFT UPPER CAP DROP DOWN DOOR	1.000	PC																		
VM2472A	BL SP UPPER CLAMP INT LOCK GLASS SLIDER		KVM2471A	BL SP INTERNAL GLASS LOCK HOLDER KIT	<table border="1"> <thead> <tr> <th>Code</th> <th>Description</th> <th>Qty</th> <th>UOM</th> </tr> </thead> <tbody> <tr> <td>VI1998A0</td> <td>ZINC PLATED SCREW 5X30 TCB</td> <td>2.000</td> <td>PC</td> </tr> <tr> <td>VM2471A0</td> <td>BL SP LOWER CLAMP INT LOCK GLASS SLIDER</td> <td>1.000</td> <td>PC</td> </tr> <tr> <td>VM2472A0</td> <td>BL SP UPPER CLAMP INT LOCK GLASS SLIDER</td> <td>1.000</td> <td>PC</td> </tr> </tbody> </table>	Code	Description	Qty	UOM	VI1998A0	ZINC PLATED SCREW 5X30 TCB	2.000	PC	VM2471A0	BL SP LOWER CLAMP INT LOCK GLASS SLIDER	1.000	PC	VM2472A0	BL SP UPPER CLAMP INT LOCK GLASS SLIDER	1.000	PC
					Code	Description	Qty	UOM													
					VI1998A0	ZINC PLATED SCREW 5X30 TCB	2.000	PC													
VM2471A0	BL SP LOWER CLAMP INT LOCK GLASS SLIDER	1.000	PC																		
VM2472A0	BL SP UPPER CLAMP INT LOCK GLASS SLIDER	1.000	PC																		
<table border="1"> <thead> <tr> <th>Code</th> <th>Description</th> <th>Qty</th> <th>UOM</th> </tr> </thead> <tbody> <tr> <td>VM2503A0</td> <td>SLIDE TO FIX INTERNAL NON REMOV GLASS SP</td> <td>2.000</td> <td>PC</td> </tr> </tbody> </table>	Code	Description	Qty	UOM	VM2503A0	SLIDE TO FIX INTERNAL NON REMOV GLASS SP	2.000	PC													
Code	Description	Qty	UOM																		
VM2503A0	SLIDE TO FIX INTERNAL NON REMOV GLASS SP	2.000	PC																		
<table border="1"> <thead> <tr> <th>Code</th> <th>Description</th> <th>Qty</th> <th>UOM</th> </tr> </thead> <tbody> <tr> <td>VM2464A0</td> <td>SHOP.PRO LEFT UPPER CAP DROP DOWN DOOR</td> <td>1.000</td> <td>PC</td> </tr> </tbody> </table>	Code	Description	Qty	UOM	VM2464A0	SHOP.PRO LEFT UPPER CAP DROP DOWN DOOR	1.000	PC													
Code	Description	Qty	UOM																		
VM2464A0	SHOP.PRO LEFT UPPER CAP DROP DOWN DOOR	1.000	PC																		

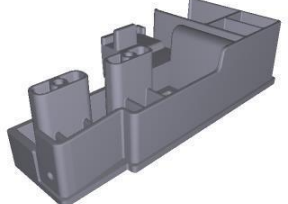
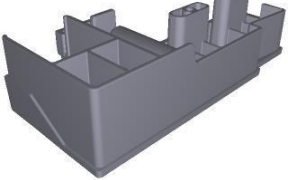





COMPONENT			SPARE PART										
Code	Description	Image	Code	Description	Kit components								
VM2503A	SLIDE TO FIX INTERNAL NON REMOV GLASS SP		KVM2503A	BL SP INT FIXED GLASS LOCK 2 PCS KIT	<table border="1"> <thead> <tr> <th>Code</th> <th>Description</th> <th>Qty</th> <th>UOM</th> </tr> </thead> <tbody> <tr> <td>VM2503A0</td> <td>SLIDE TO FIX INTERNAL NON REMOV GLASS SP</td> <td>2.000</td> <td>PC</td> </tr> </tbody> </table>	Code	Description	Qty	UOM	VM2503A0	SLIDE TO FIX INTERNAL NON REMOV GLASS SP	2.000	PC
Code	Description	Qty	UOM										
VM2503A0	SLIDE TO FIX INTERNAL NON REMOV GLASS SP	2.000	PC										
VM2463A	SHOP.PRO RIGHT UPPER CAP DROP DOWN DOOR		KVM2463A	BL SP RIGHT UPPER DROPDOWN DOOR CAP KIT	<table border="1"> <thead> <tr> <th>Code</th> <th>Description</th> <th>Qty</th> <th>UOM</th> </tr> </thead> <tbody> <tr> <td>VM2463A0</td> <td>SHOP.PRO RIGHT UPPER CAP DROP DOWN DOOR</td> <td>1.000</td> <td>PC</td> </tr> </tbody> </table>	Code	Description	Qty	UOM	VM2463A0	SHOP.PRO RIGHT UPPER CAP DROP DOWN DOOR	1.000	PC
Code	Description	Qty	UOM										
VM2463A0	SHOP.PRO RIGHT UPPER CAP DROP DOWN DOOR	1.000	PC										
TB1563A	DOOR LATERAL BEAM SP800		TB1563A0	DOOR LATERAL BEAM SP800									
VM2461A	BL SP RIGHT LOWER DROPDOWN DOOR CAP KIT		KVM2461A	BL SP RIGHT LOWER DROPDOWN DOOR CAP KIT	<table border="1"> <thead> <tr> <th>Code</th> <th>Description</th> <th>Qty</th> <th>UOM</th> </tr> </thead> <tbody> <tr> <td>VM2461A0</td> <td>BL SP RIGHT LOWER DROPDOWN DOOR CAP KIT</td> <td>1.000</td> <td>PC</td> </tr> </tbody> </table>	Code	Description	Qty	UOM	VM2461A0	BL SP RIGHT LOWER DROPDOWN DOOR CAP KIT	1.000	PC
Code	Description	Qty	UOM										
VM2461A0	BL SP RIGHT LOWER DROPDOWN DOOR CAP KIT	1.000	PC										
VM2462A	BL SP LEFT LOWER DROPDOWN DOOR CAP		KVM2462A	BL SP LEFT LOWER DROPDOWN DOOR CAP KIT	<table border="1"> <thead> <tr> <th>Code</th> <th>Description</th> <th>Qty</th> <th>UOM</th> </tr> </thead> <tbody> <tr> <td>VM2462A0</td> <td>BL SP LEFT LOWER DROPDOWN DOOR CAP</td> <td>1.000</td> <td>PC</td> </tr> </tbody> </table>	Code	Description	Qty	UOM	VM2462A0	BL SP LEFT LOWER DROPDOWN DOOR CAP	1.000	PC
Code	Description	Qty	UOM										
VM2462A0	BL SP LEFT LOWER DROPDOWN DOOR CAP	1.000	PC										





COMPONENT			SPARE PART														
Code	Description	Image	Code	Description	Kit components												
VM1630A	INTERNAL GLASS PUSHING CAP		KVM1630A	CAP FOR INTERNAL GLASS 10 PCS KIT	<table border="1"> <thead> <tr> <th>Code</th> <th>Description</th> <th>Qty</th> <th>UOM</th> </tr> </thead> <tbody> <tr> <td>VM1630A1</td> <td>INTERNAL GLASS PUSHING CAP</td> <td>10.000</td> <td>PC</td> </tr> </tbody> </table>	Code	Description	Qty	UOM	VM1630A1	INTERNAL GLASS PUSHING CAP	10.000	PC				
Code	Description	Qty	UOM														
VM1630A1	INTERNAL GLASS PUSHING CAP	10.000	PC														
VM2479A	BL SP GLASS H6 PUSHING BRACKET		KVM2479A	BL SHOP.PRO H6 GLASS SUPPORT 6 PCS KIT	<table border="1"> <thead> <tr> <th>Code</th> <th>Description</th> <th>Qty</th> <th>UOM</th> </tr> </thead> <tbody> <tr> <td>VM1630A1</td> <td>INTERNAL GLASS PUSHING CAP</td> <td>6.000</td> <td>PC</td> </tr> <tr> <td>VM2479A0</td> <td>BL SP GLASS H6 PUSHING BRACKET</td> <td>6.000</td> <td>PC</td> </tr> </tbody> </table>	Code	Description	Qty	UOM	VM1630A1	INTERNAL GLASS PUSHING CAP	6.000	PC	VM2479A0	BL SP GLASS H6 PUSHING BRACKET	6.000	PC
Code	Description	Qty	UOM														
VM1630A1	INTERNAL GLASS PUSHING CAP	6.000	PC														
VM2479A0	BL SP GLASS H6 PUSHING BRACKET	6.000	PC														
CE1095A	4 POLES MICROFIT 2 M BUS CABLE		KCE1095A	4POLES 2M BUS CABLE KIT POWER-CONTROL	<table border="1"> <thead> <tr> <th>Code</th> <th>Description</th> <th>Qty</th> <th>UOM</th> </tr> </thead> <tbody> <tr> <td>CE1095A0</td> <td>4 POLES MICROFIT 2 M BUS CABLE</td> <td>1.000</td> <td>PC</td> </tr> </tbody> </table>	Code	Description	Qty	UOM	CE1095A0	4 POLES MICROFIT 2 M BUS CABLE	1.000	PC				
Code	Description	Qty	UOM														
CE1095A0	4 POLES MICROFIT 2 M BUS CABLE	1.000	PC														
CE1285A	EMI ROUND FERRITE MOD.2643801502		KCE1285A	ROUND FERRITE ELECTROMAGN PROT. 2PCS KIT	<table border="1"> <thead> <tr> <th>Code</th> <th>Description</th> <th>Qty</th> <th>UOM</th> </tr> </thead> <tbody> <tr> <td>CE1285A0</td> <td>EMI ROUND FERRITE MOD.2643801502</td> <td>2.000</td> <td>PC</td> </tr> </tbody> </table>	Code	Description	Qty	UOM	CE1285A0	EMI ROUND FERRITE MOD.2643801502	2.000	PC				
Code	Description	Qty	UOM														
CE1285A0	EMI ROUND FERRITE MOD.2643801502	2.000	PC														
CR1112A	BLSP ARIANNA-ELENA DROPDOWN DOOR HINGE		KCR1112A	BAKERLUX SP ARIANNA-ELENA HINGE KIT	<table border="1"> <thead> <tr> <th>Code</th> <th>Description</th> <th>Qty</th> <th>UOM</th> </tr> </thead> <tbody> <tr> <td>CR1112A1</td> <td></td> <td>1.000</td> <td>PC</td> </tr> <tr> <td>VI1280A3</td> <td>M5x10 TC1/2T SCREW</td> <td>3.000</td> <td>PC</td> </tr> </tbody> </table>	Code	Description	Qty	UOM	CR1112A1		1.000	PC	VI1280A3	M5x10 TC1/2T SCREW	3.000	PC
Code	Description	Qty	UOM														
CR1112A1		1.000	PC														
VI1280A3	M5x10 TC1/2T SCREW	3.000	PC														

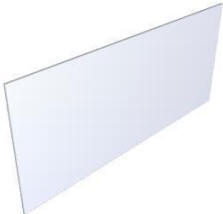

COMPONENT			SPARE PART														
Code	Description	Image	Code	Description	Kit components												
PE2127A	SP DECK CONTROL BOARD KIT		KPE2127A	BAKERLUX SP DECK CONTROL BOARD KIT	<table border="1"> <thead> <tr> <th>Code</th> <th>Description</th> <th>Qty</th> <th>UOM</th> </tr> </thead> <tbody> <tr> <td>PE2127A0</td> <td>SP DECK CONTROL BOARD KIT</td> <td>1.000</td> <td>PC</td> </tr> <tr> <td>VI1147A0</td> <td>5X25 STAINLESS STEEL SCREW</td> <td>2.000</td> <td>PC</td> </tr> </tbody> </table>	Code	Description	Qty	UOM	PE2127A0	SP DECK CONTROL BOARD KIT	1.000	PC	VI1147A0	5X25 STAINLESS STEEL SCREW	2.000	PC
Code	Description	Qty	UOM														
PE2127A0	SP DECK CONTROL BOARD KIT	1.000	PC														
VI1147A0	5X25 STAINLESS STEEL SCREW	2.000	PC														
VM2512A	BL SP DOOR-MICROSWITCH SOFT CLOSING		KVM2512A	BL SP DOOR-MICROSWITCH SOFT CLOSING KIT	<table border="1"> <thead> <tr> <th>Code</th> <th>Description</th> <th>Qty</th> <th>UOM</th> </tr> </thead> <tbody> <tr> <td>VM1339A0</td> <td></td> <td>1.000</td> <td>PC</td> </tr> </tbody> </table>	Code	Description	Qty	UOM	VM1339A0		1.000	PC				
Code	Description	Qty	UOM														
VM1339A0		1.000	PC														
VT1331A	SP ELENA 715x318.5x6 INNER GLASS		KVT1331A	BL SP ELENA DOOR INNER GLASS KIT	<table border="1"> <thead> <tr> <th>Code</th> <th>Description</th> <th>Qty</th> <th>UOM</th> </tr> </thead> <tbody> <tr> <td>VT1331A0</td> <td>SP ELENA 715x318.5x6 INNER GLASS</td> <td>1.000</td> <td>PC</td> </tr> </tbody> </table>	Code	Description	Qty	UOM	VT1331A0	SP ELENA 715x318.5x6 INNER GLASS	1.000	PC				
Code	Description	Qty	UOM														
VT1331A0	SP ELENA 715x318.5x6 INNER GLASS	1.000	PC														
VT1363A	VT1363A0		VT1363A0	VT1363A0													



**ASM4295A/0.D00 - External cover**

**FRONT**

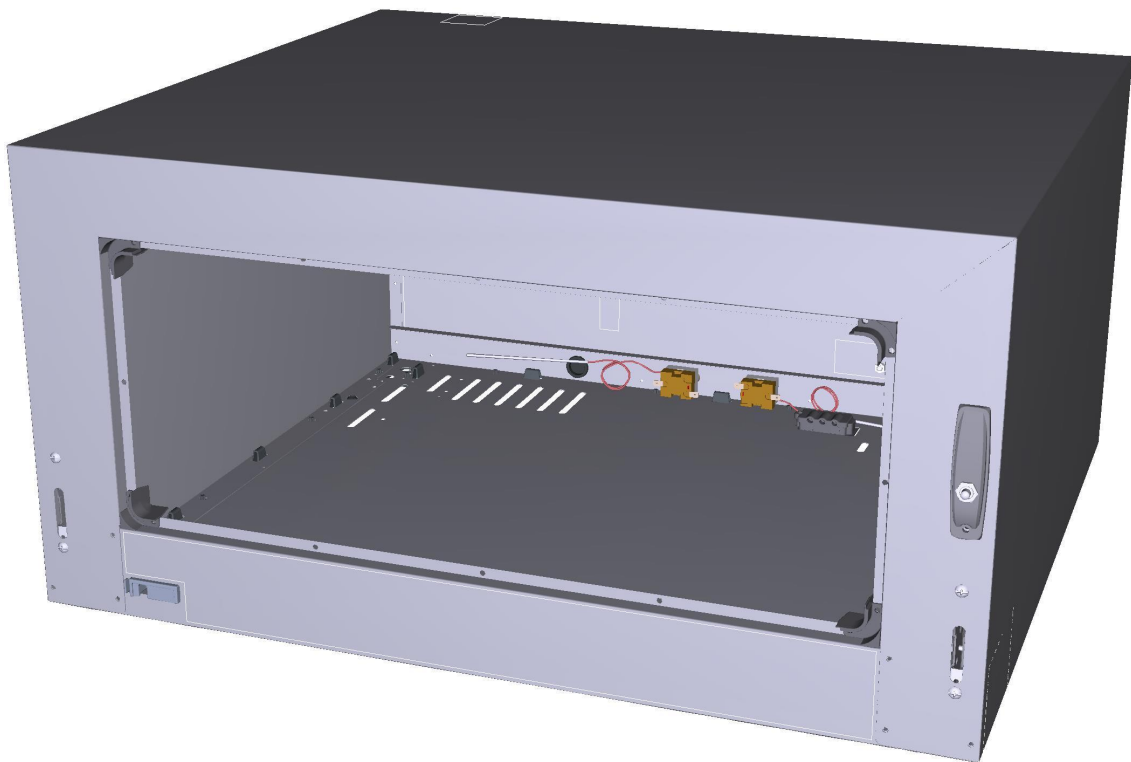







**ASM4295A/0.D00 - External cover**

**REAR**









COMPONENT			SPARE PART																		
Code	Description	Image	Code	Description	Kit components																
0D2489A	SHOP PRO DECK EXTERNAL CASING		0D2489A0	SHOP PRO DECK EXTERNAL CASING																	
0E1395A	0E1395A0		0E1395A0	0E1395A0																	
0F1549A	SP DECK EXTERNAL BACK PANEL		0F1549A0	SP DECK EXTERNAL BACK PANEL																	
CR1000A	HINGE LATCH L.M.		KCR1000A	LM HINGES LATCH KIT	<table border="1"> <thead> <tr> <th>Code</th> <th>Description</th> <th>Qty</th> <th>UOM</th> </tr> </thead> <tbody> <tr> <td>CR1000A0</td> <td>HINGE LATCH L.M.</td> <td>1.000</td> <td>PC</td> </tr> <tr> <td>VI1280A3</td> <td>M5x10 TC1/2T SCREW</td> <td>2.000</td> <td>PC</td> </tr> </tbody> </table>	Code	Description	Qty	UOM	CR1000A0	HINGE LATCH L.M.	1.000	PC	VI1280A3	M5x10 TC1/2T SCREW	2.000	PC				
Code	Description	Qty	UOM																		
CR1000A0	HINGE LATCH L.M.	1.000	PC																		
VI1280A3	M5x10 TC1/2T SCREW	2.000	PC																		
VM1555A	CT BT COOLING FAN SUPPORT		KVN1165A	S.5E ADVANCE/MM 230V COOLING FAN KIT	<table border="1"> <thead> <tr> <th>Code</th> <th>Description</th> <th>Qty</th> <th>UOM</th> </tr> </thead> <tbody> <tr> <td>VI1099A0</td> <td>SELF-DRILLIN G SCREW 4.8X13 TCB+ Z</td> <td>4.000</td> <td>PC</td> </tr> <tr> <td>VM1555A2</td> <td>CT BT COOLING FAN SUPPORT</td> <td>1.000</td> <td>PC</td> </tr> <tr> <td>VN1165A0</td> <td>230Vac 50/60Hz COOLING DOWN FAN</td> <td>1.000</td> <td>PC</td> </tr> </tbody> </table>	Code	Description	Qty	UOM	VI1099A0	SELF-DRILLIN G SCREW 4.8X13 TCB+ Z	4.000	PC	VM1555A2	CT BT COOLING FAN SUPPORT	1.000	PC	VN1165A0	230Vac 50/60Hz COOLING DOWN FAN	1.000	PC
Code	Description	Qty	UOM																		
VI1099A0	SELF-DRILLIN G SCREW 4.8X13 TCB+ Z	4.000	PC																		
VM1555A2	CT BT COOLING FAN SUPPORT	1.000	PC																		
VN1165A0	230Vac 50/60Hz COOLING DOWN FAN	1.000	PC																		



COMPONENT			SPARE PART																		
Code	Description	Image	Code	Description	Kit components																
VM1555A	CT BT COOLING FAN SUPPORT		KVN1164A	S.5/5E 12VDC COOLING DOWN FAN KIT	<table border="1"> <thead> <tr> <th>Code</th> <th>Description</th> <th>Qty</th> <th>UOM</th> </tr> </thead> <tbody> <tr> <td>VI1099A0</td> <td>SELF-DRILLIN G SCREW 4.8X13 TCB+ Z</td> <td>4.000</td> <td>PC</td> </tr> <tr> <td>VM1555A2</td> <td>CT BT COOLING FAN SUPPORT</td> <td>1.000</td> <td>PC</td> </tr> <tr> <td>VN1164A0</td> <td>12VDC COOLING DOWN FAN</td> <td>1.000</td> <td>PC</td> </tr> </tbody> </table>	Code	Description	Qty	UOM	VI1099A0	SELF-DRILLIN G SCREW 4.8X13 TCB+ Z	4.000	PC	VM1555A2	CT BT COOLING FAN SUPPORT	1.000	PC	VN1164A0	12VDC COOLING DOWN FAN	1.000	PC
Code	Description	Qty	UOM																		
VI1099A0	SELF-DRILLIN G SCREW 4.8X13 TCB+ Z	4.000	PC																		
VM1555A2	CT BT COOLING FAN SUPPORT	1.000	PC																		
VN1164A0	12VDC COOLING DOWN FAN	1.000	PC																		
VM1556A	XBC-XVC COOLING FAN GUARD		KVM1556A	XBC-XVC COOLING FAN GUARD KIT	<table border="1"> <thead> <tr> <th>Code</th> <th>Description</th> <th>Qty</th> <th>UOM</th> </tr> </thead> <tbody> <tr> <td>VM1556A0</td> <td>XBC-XVC COOLING FAN GUARD</td> <td>1.000</td> <td>PC</td> </tr> </tbody> </table>	Code	Description	Qty	UOM	VM1556A0	XBC-XVC COOLING FAN GUARD	1.000	PC								
Code	Description	Qty	UOM																		
VM1556A0	XBC-XVC COOLING FAN GUARD	1.000	PC																		
VN1165A	230Vac 50/60Hz COOLING DOWN FA		KVN1165A	S.5E ADVANCE/MM 230V COOLING FAN KIT	<table border="1"> <thead> <tr> <th>Code</th> <th>Description</th> <th>Qty</th> <th>UOM</th> </tr> </thead> <tbody> <tr> <td>VI1099A0</td> <td>SELF-DRILLIN G SCREW 4.8X13 TCB+ Z</td> <td>4.000</td> <td>PC</td> </tr> <tr> <td>VM1555A2</td> <td>CT BT COOLING FAN SUPPORT</td> <td>1.000</td> <td>PC</td> </tr> <tr> <td>VN1165A0</td> <td>230Vac 50/60Hz COOLING DOWN FAN</td> <td>1.000</td> <td>PC</td> </tr> </tbody> </table>	Code	Description	Qty	UOM	VI1099A0	SELF-DRILLIN G SCREW 4.8X13 TCB+ Z	4.000	PC	VM1555A2	CT BT COOLING FAN SUPPORT	1.000	PC	VN1165A0	230Vac 50/60Hz COOLING DOWN FAN	1.000	PC
Code	Description	Qty	UOM																		
VI1099A0	SELF-DRILLIN G SCREW 4.8X13 TCB+ Z	4.000	PC																		
VM1555A2	CT BT COOLING FAN SUPPORT	1.000	PC																		
VN1165A0	230Vac 50/60Hz COOLING DOWN FAN	1.000	PC																		
VE1295A	MK 16A 230V DOOR MICROSWITCH		KVE1295A	16A 230V DOOR MICROSWITCH KIT	<table border="1"> <thead> <tr> <th>Code</th> <th>Description</th> <th>Qty</th> <th>UOM</th> </tr> </thead> <tbody> <tr> <td>VE1295A0</td> <td>MK 16A 230V DOOR MICROSWITCH</td> <td>1.000</td> <td>PC</td> </tr> </tbody> </table>	Code	Description	Qty	UOM	VE1295A0	MK 16A 230V DOOR MICROSWITCH	1.000	PC								
Code	Description	Qty	UOM																		
VE1295A0	MK 16A 230V DOOR MICROSWITCH	1.000	PC																		
VM2508A	BAKERLUX SHOP.PRO DOOR SWITCH COVER		KVM2508A	BAKERLUX SHOP.PRO MICROSWITCH COVER KIT	<table border="1"> <thead> <tr> <th>Code</th> <th>Description</th> <th>Qty</th> <th>UOM</th> </tr> </thead> <tbody> <tr> <td>VM2508A0</td> <td>BAKERLUX SHOP.PRO DOOR SWITCH COVE</td> <td>1.000</td> <td>PC</td> </tr> </tbody> </table>	Code	Description	Qty	UOM	VM2508A0	BAKERLUX SHOP.PRO DOOR SWITCH COVE	1.000	PC								
Code	Description	Qty	UOM																		
VM2508A0	BAKERLUX SHOP.PRO DOOR SWITCH COVE	1.000	PC																		



COMPONENT			SPARE PART																										
Code	Description	Image	Code	Description	Kit components																								
VM1631A	PLUS INNER GLASS PUSHING CAP		KVM1631A	CAP FOR INTERNAL GLASS 10 PCS KIT	<table border="1"> <thead> <tr> <th>Code</th> <th>Description</th> <th>Qty</th> <th>UOM</th> </tr> </thead> <tbody> <tr> <td>VM1631A0</td> <td>PLUS INNER GLASS PUSHING CAP</td> <td>10.000</td> <td>PC</td> </tr> </tbody> </table>	Code	Description	Qty	UOM	VM1631A0	PLUS INNER GLASS PUSHING CAP	10.000	PC																
Code	Description	Qty	UOM																										
VM1631A0	PLUS INNER GLASS PUSHING CAP	10.000	PC																										
VM2492A	BL SP 600x400 EXT BOTTOM PANEL GASKET		KVM2492A	SP 600X400 EXT BOT PANEL GASKET 2PC KIT	<table border="1"> <thead> <tr> <th>Code</th> <th>Description</th> <th>Qty</th> <th>UOM</th> </tr> </thead> <tbody> <tr> <td>VM1794A0</td> <td>250x4.8 PA66 BLACK CLAMP</td> <td>1.000</td> <td>PC</td> </tr> <tr> <td>VM2103A0</td> <td>CLAMP LOCK</td> <td>1.000</td> <td>PC</td> </tr> <tr> <td>VM2492A0</td> <td>BL SP 600x400 EXT BOTTOM PANEL GASKE</td> <td>2.000</td> <td>PC</td> </tr> </tbody> </table>	Code	Description	Qty	UOM	VM1794A0	250x4.8 PA66 BLACK CLAMP	1.000	PC	VM2103A0	CLAMP LOCK	1.000	PC	VM2492A0	BL SP 600x400 EXT BOTTOM PANEL GASKE	2.000	PC								
Code	Description	Qty	UOM																										
VM1794A0	250x4.8 PA66 BLACK CLAMP	1.000	PC																										
VM2103A0	CLAMP LOCK	1.000	PC																										
VM2492A0	BL SP 600x400 EXT BOTTOM PANEL GASKE	2.000	PC																										
VM2493A	BL SP 600x400 EX LAT BOTTOM PANEL GASKET		KVM2493A	SP 600X400 BOT LAT PANEL GASKET 2PC KIT	<table border="1"> <thead> <tr> <th>Code</th> <th>Description</th> <th>Qty</th> <th>UOM</th> </tr> </thead> <tbody> <tr> <td>VM1631A0</td> <td>PLUS INNER GLASS PUSHING CAP</td> <td>4.000</td> <td>PC</td> </tr> <tr> <td>VM1794A0</td> <td>250x4.8 PA66 BLACK CLAMP</td> <td>1.000</td> <td>PC</td> </tr> <tr> <td>VM2103A0</td> <td>CLAMP LOCK</td> <td>1.000</td> <td>PC</td> </tr> <tr> <td>VM2493A1</td> <td>EXT. LATERAL BACK GASKET SP800</td> <td>2.000</td> <td>PC</td> </tr> </tbody> </table>	Code	Description	Qty	UOM	VM1631A0	PLUS INNER GLASS PUSHING CAP	4.000	PC	VM1794A0	250x4.8 PA66 BLACK CLAMP	1.000	PC	VM2103A0	CLAMP LOCK	1.000	PC	VM2493A1	EXT. LATERAL BACK GASKET SP800	2.000	PC				
Code	Description	Qty	UOM																										
VM1631A0	PLUS INNER GLASS PUSHING CAP	4.000	PC																										
VM1794A0	250x4.8 PA66 BLACK CLAMP	1.000	PC																										
VM2103A0	CLAMP LOCK	1.000	PC																										
VM2493A1	EXT. LATERAL BACK GASKET SP800	2.000	PC																										
TR1136A	318°C -0/+24 1 POLE SAFETY THERMOSTAT		KTR1136A	318°C -0/+24 SAFETY THERMOSTAT KIT	<table border="1"> <thead> <tr> <th>Code</th> <th>Description</th> <th>Qty</th> <th>UOM</th> </tr> </thead> <tbody> <tr> <td>0H7030A0</td> <td>THERMOSTAT BULB INLET COVER</td> <td>1.000</td> <td>PC</td> </tr> <tr> <td>GN1531A0</td> <td>THERMOSTAT BULB INLET SEALING</td> <td>1.000</td> <td>PC</td> </tr> <tr> <td>SL1045A0</td> <td>S57 BLACK SILICONE - 80ml CARTRIDGE</td> <td>1.000</td> <td>PC</td> </tr> <tr> <td>TR1136A0</td> <td>318°C -0/+24 1 POLE SAFETY THERMOSTAT</td> <td>1.000</td> <td>PC</td> </tr> <tr> <td>VI1220A1</td> <td>4,2x12 TCB SELF-TAPPIN G SCREW</td> <td>3.000</td> <td>PC</td> </tr> </tbody> </table>	Code	Description	Qty	UOM	0H7030A0	THERMOSTAT BULB INLET COVER	1.000	PC	GN1531A0	THERMOSTAT BULB INLET SEALING	1.000	PC	SL1045A0	S57 BLACK SILICONE - 80ml CARTRIDGE	1.000	PC	TR1136A0	318°C -0/+24 1 POLE SAFETY THERMOSTAT	1.000	PC	VI1220A1	4,2x12 TCB SELF-TAPPIN G SCREW	3.000	PC
Code	Description	Qty	UOM																										
0H7030A0	THERMOSTAT BULB INLET COVER	1.000	PC																										
GN1531A0	THERMOSTAT BULB INLET SEALING	1.000	PC																										
SL1045A0	S57 BLACK SILICONE - 80ml CARTRIDGE	1.000	PC																										
TR1136A0	318°C -0/+24 1 POLE SAFETY THERMOSTAT	1.000	PC																										
VI1220A1	4,2x12 TCB SELF-TAPPIN G SCREW	3.000	PC																										



COMPONENT			SPARE PART																						
Code	Description	Image	Code	Description	Kit components																				
VE1075A	STRAIN RELIEF PA6 UL94V2+ FIXING SCREWS		KVE1075A	PANEL WIRE CLAMP 10PCS KIT	<table border="1"> <thead> <tr> <th>Code</th> <th>Description</th> <th>Qty</th> <th>UOM</th> </tr> </thead> <tbody> <tr> <td>VE1075A0</td> <td>STRAIN RELIEF PA6 UL94V2+ FIXING SCREWS</td> <td>10.000</td> <td>PC</td> </tr> </tbody> </table>	Code	Description	Qty	UOM	VE1075A0	STRAIN RELIEF PA6 UL94V2+ FIXING SCREWS	10.000	PC												
Code	Description	Qty	UOM																						
VE1075A0	STRAIN RELIEF PA6 UL94V2+ FIXING SCREWS	10.000	PC																						
VM1310A	COVER FOR XB/XV/XVC/XG TERMINAL BLOCK		VM1310A0	COVER FOR XB/XV/XVC/XG TERMINAL BLOCK																					
VM1505A	WALL PASSING WITH DIAPHRAGM		KVM1505A	THROUGH-WALL CONNECTION+DIAPHRAGM KIT	<table border="1"> <thead> <tr> <th>Code</th> <th>Description</th> <th>Qty</th> <th>UOM</th> </tr> </thead> <tbody> <tr> <td>VI1220A1</td> <td>4,2x12 TCB SELF-TAPPING G.SCREW</td> <td>1.000</td> <td>PC</td> </tr> <tr> <td>VM1505A0</td> <td>WALL PASSING WITH DIAPHRAGM</td> <td>3.000</td> <td>PC</td> </tr> <tr> <td>VM2055A0</td> <td>UPPER WALL PASSING ACCESSORY CABLES</td> <td>1.000</td> <td>PC</td> </tr> <tr> <td>VM2056A0</td> <td>LOWER WALL PASSING ACCESSORY CABLES</td> <td>1.000</td> <td>PC</td> </tr> </tbody> </table>	Code	Description	Qty	UOM	VI1220A1	4,2x12 TCB SELF-TAPPING G.SCREW	1.000	PC	VM1505A0	WALL PASSING WITH DIAPHRAGM	3.000	PC	VM2055A0	UPPER WALL PASSING ACCESSORY CABLES	1.000	PC	VM2056A0	LOWER WALL PASSING ACCESSORY CABLES	1.000	PC
Code	Description	Qty	UOM																						
VI1220A1	4,2x12 TCB SELF-TAPPING G.SCREW	1.000	PC																						
VM1505A0	WALL PASSING WITH DIAPHRAGM	3.000	PC																						
VM2055A0	UPPER WALL PASSING ACCESSORY CABLES	1.000	PC																						
VM2056A0	LOWER WALL PASSING ACCESSORY CABLES	1.000	PC																						
VM1750A	BRASS COMB CLAM		KVM1750A	COMB TERMINAL BLOCK KIT	<table border="1"> <thead> <tr> <th>Code</th> <th>Description</th> <th>Qty</th> <th>UOM</th> </tr> </thead> <tbody> <tr> <td>VI1040A0</td> <td>INDENTED INTERNAL WASHER D=6 ZN</td> <td>2.000</td> <td>PC</td> </tr> <tr> <td>VM1750A0</td> <td>BRASS COMB CLAMP</td> <td>1.000</td> <td>PC</td> </tr> </tbody> </table>	Code	Description	Qty	UOM	VI1040A0	INDENTED INTERNAL WASHER D=6 ZN	2.000	PC	VM1750A0	BRASS COMB CLAMP	1.000	PC								
Code	Description	Qty	UOM																						
VI1040A0	INDENTED INTERNAL WASHER D=6 ZN	2.000	PC																						
VM1750A0	BRASS COMB CLAMP	1.000	PC																						





COMPONENT			SPARE PART																						
Code	Description	Image	Code	Description	Kit components																				
VM1951A	CHIMNEY COVER		KVM1951A	EXHAUST CHIMNEY COVER KIT	<table border="1"> <thead> <tr> <th>Code</th> <th>Description</th> <th>Qty</th> <th>UOM</th> </tr> </thead> <tbody> <tr> <td>VI1220A1</td> <td>4,2x12 TCB SELF-TAPPIN G SCREW</td> <td>2.000</td> <td>PC</td> </tr> <tr> <td>VM1951A1</td> <td>CHIMNEY COVER</td> <td>1.000</td> <td>PC</td> </tr> </tbody> </table>	Code	Description	Qty	UOM	VI1220A1	4,2x12 TCB SELF-TAPPIN G SCREW	2.000	PC	VM1951A1	CHIMNEY COVER	1.000	PC								
Code	Description	Qty	UOM																						
VI1220A1	4,2x12 TCB SELF-TAPPIN G SCREW	2.000	PC																						
VM1951A1	CHIMNEY COVER	1.000	PC																						
VM1983A	R10 GASKET ANGLE		VM1983A0	R10 GASKET ANGLE																					
VM2061A	ACCESSORIES CABLES WALL PASSING		KVM1505A	THROUGH-WALL CONNECTION+DIAPHRAGM KIT	<table border="1"> <thead> <tr> <th>Code</th> <th>Description</th> <th>Qty</th> <th>UOM</th> </tr> </thead> <tbody> <tr> <td>VI1220A1</td> <td>4,2x12 TCB SELF-TAPPIN G SCREW</td> <td>1.000</td> <td>PC</td> </tr> <tr> <td>VM1505A0</td> <td>WALL PASSING WITH DIAPHRAGM</td> <td>3.000</td> <td>PC</td> </tr> <tr> <td>VM2055A0</td> <td>UPPER WALL PASSING ACCESSORY CABLES</td> <td>1.000</td> <td>PC</td> </tr> <tr> <td>VM2056A0</td> <td>LOWER WALL PASSING ACCESSORY CABLES</td> <td>1.000</td> <td>PC</td> </tr> </tbody> </table>	Code	Description	Qty	UOM	VI1220A1	4,2x12 TCB SELF-TAPPIN G SCREW	1.000	PC	VM1505A0	WALL PASSING WITH DIAPHRAGM	3.000	PC	VM2055A0	UPPER WALL PASSING ACCESSORY CABLES	1.000	PC	VM2056A0	LOWER WALL PASSING ACCESSORY CABLES	1.000	PC
Code	Description	Qty	UOM																						
VI1220A1	4,2x12 TCB SELF-TAPPIN G SCREW	1.000	PC																						
VM1505A0	WALL PASSING WITH DIAPHRAGM	3.000	PC																						
VM2055A0	UPPER WALL PASSING ACCESSORY CABLES	1.000	PC																						
VM2056A0	LOWER WALL PASSING ACCESSORY CABLES	1.000	PC																						
VM2455A	BL SP CONTROL BOARD CABLE PASS-THROUGH		KVM2455A	BL SP CONTR BOARD CABLE PASS-THROUGH KIT	<table border="1"> <thead> <tr> <th>Code</th> <th>Description</th> <th>Qty</th> <th>UOM</th> </tr> </thead> <tbody> <tr> <td>VM2455A1</td> <td>SP CONTROL BOARD CABLE PASS-THROU GH CLIP</td> <td>1.000</td> <td>PC</td> </tr> </tbody> </table>	Code	Description	Qty	UOM	VM2455A1	SP CONTROL BOARD CABLE PASS-THROU GH CLIP	1.000	PC												
Code	Description	Qty	UOM																						
VM2455A1	SP CONTROL BOARD CABLE PASS-THROU GH CLIP	1.000	PC																						





**ASM4296A/0.D00 - Electrical system**





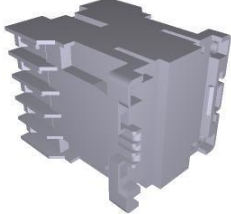

### ASM4296A/0.D00 - Electrical system



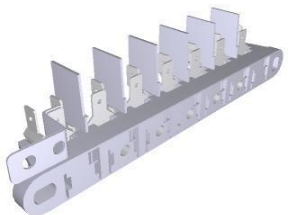
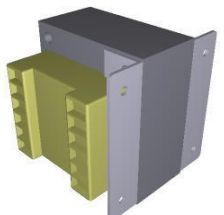

COMPONENT			SPARE PART														
Code	Description	Image	Code	Description	Kit components												
0P1027A	0P1027A0		0P1027A0	0P1027A0													
VE1115A	20 A 230V 4 POLES MINICONTACTOR		KVE1115A	20A 230V 4 POLES MINICONTACTOR KI	<table border="1"> <thead> <tr> <th>Code</th> <th>Description</th> <th>Qty</th> <th>UOM</th> </tr> </thead> <tbody> <tr> <td>VE1115A0</td> <td>20 A 230V 4 POLES MINICONTACTOR</td> <td>1.000</td> <td>PC</td> </tr> <tr> <td>VM1075A1</td> <td>PLASTIC CLIP TO FIX CONTACTORS</td> <td>4.000</td> <td>PC</td> </tr> </tbody> </table>	Code	Description	Qty	UOM	VE1115A0	20 A 230V 4 POLES MINICONTACTOR	1.000	PC	VM1075A1	PLASTIC CLIP TO FIX CONTACTORS	4.000	PC
Code	Description	Qty	UOM														
VE1115A0	20 A 230V 4 POLES MINICONTACTOR	1.000	PC														
VM1075A1	PLASTIC CLIP TO FIX CONTACTORS	4.000	PC														
VM1056A	SMALL CONTACTOR BRACKET VE1115A		VM1056A0	SMALL CONTACTOR BRACKET VE1115A													
PE2133A	SHOP.PRO DECK POWER BOARD KIT		KPE2133A	SHOP.PRO DECK POWER CARD KIT	<table border="1"> <thead> <tr> <th>Code</th> <th>Description</th> <th>Qty</th> <th>UOM</th> </tr> </thead> <tbody> <tr> <td>PE2133A0</td> <td>SHOP.PRO DECK POWER BOARD KIT</td> <td>1.000</td> <td>PC</td> </tr> </tbody> </table>	Code	Description	Qty	UOM	PE2133A0	SHOP.PRO DECK POWER BOARD KIT	1.000	PC				
Code	Description	Qty	UOM														
PE2133A0	SHOP.PRO DECK POWER BOARD KIT	1.000	PC														
VM1746A	H10 M4 JOINT BOARD FASTENING CLIP		KVM1746A	BOARD FIXING CLIP JOINT-M4 KIT	<table border="1"> <thead> <tr> <th>Code</th> <th>Description</th> <th>Qty</th> <th>UOM</th> </tr> </thead> <tbody> <tr> <td>VM1746A0</td> <td>H10 M4 JOINT BOARD FASTENING CLIP</td> <td>10.000</td> <td>PC</td> </tr> </tbody> </table>	Code	Description	Qty	UOM	VM1746A0	H10 M4 JOINT BOARD FASTENING CLIP	10.000	PC				
Code	Description	Qty	UOM														
VM1746A0	H10 M4 JOINT BOARD FASTENING CLIP	10.000	PC														

COMPONENT			SPARE PART														
Code	Description	Image	Code	Description	Kit components												
VM1747A	JOINT-PIN H10 POWER BOARD FASTENING CLIP		KVM1747A	BOARD FIXING CLIP JOINT-PIN KIT	<table border="1"> <thead> <tr> <th>Code</th> <th>Description</th> <th>Qty</th> <th>UOM</th> </tr> </thead> <tbody> <tr> <td>VM1747A0</td> <td>JOINT-PIN H10 POWER BOARD FASTENING CLIP</td> <td>10.000</td> <td>PC</td> </tr> </tbody> </table>	Code	Description	Qty	UOM	VM1747A0	JOINT-PIN H10 POWER BOARD FASTENING CLIP	10.000	PC				
Code	Description	Qty	UOM														
VM1747A0	JOINT-PIN H10 POWER BOARD FASTENING CLIP	10.000	PC														
CE1580A	SCHUKO PLUG + 3G X 1,5 MMQ CABLE		CE1580A0	SCHUKO PLUG + 3G X 1,5 MMQ CABLE													
MR1004A	41A 450V 7 POLES TERMINAL		KMR1004A	7FTW 1+2+3/4+5+6 TERMINAL BLOCK KIT	<table border="1"> <thead> <tr> <th>Code</th> <th>Description</th> <th>Qty</th> <th>UOM</th> </tr> </thead> <tbody> <tr> <td>MR1004A1</td> <td>41A 450V 7 POLES TERMINAL</td> <td>1.000</td> <td>PC</td> </tr> </tbody> </table>	Code	Description	Qty	UOM	MR1004A1	41A 450V 7 POLES TERMINAL	1.000	PC				
Code	Description	Qty	UOM														
MR1004A1	41A 450V 7 POLES TERMINAL	1.000	PC														
VE1639A	TRANSFORMER 230-12Vac 60VA		KVE1639A	230-12Vac 60VA TRANSFORMER KIT	<table border="1"> <thead> <tr> <th>Code</th> <th>Description</th> <th>Qty</th> <th>UOM</th> </tr> </thead> <tbody> <tr> <td>VE1639A0</td> <td>TRANSFORME R 230-12Vac 60VA</td> <td>1.000</td> <td>PC</td> </tr> <tr> <td>VI1950A0</td> <td>ST. STEEL 4,2X13 TCB SELF-DRILLIN G SCREW</td> <td>4.000</td> <td>PC</td> </tr> </tbody> </table>	Code	Description	Qty	UOM	VE1639A0	TRANSFORME R 230-12Vac 60VA	1.000	PC	VI1950A0	ST. STEEL 4,2X13 TCB SELF-DRILLIN G SCREW	4.000	PC
Code	Description	Qty	UOM														
VE1639A0	TRANSFORME R 230-12Vac 60VA	1.000	PC														
VI1950A0	ST. STEEL 4,2X13 TCB SELF-DRILLIN G SCREW	4.000	PC														
VM2617A	DECK TERMINAL BLOCK PROTECTIO		VM2617A0	DECK TERMINAL BLOCK PROTECTIO													