







Assembly code	Assembly description	Assembly image
ASM3402A/0.D02	Cooking chamber	
ASM3414A/0.D01	External cover	
ASM3427A/0.D00	Door	
ASM3438A/0.D01	Electrical system	



**ASM3402A/0.D02 - Cooking chamber**



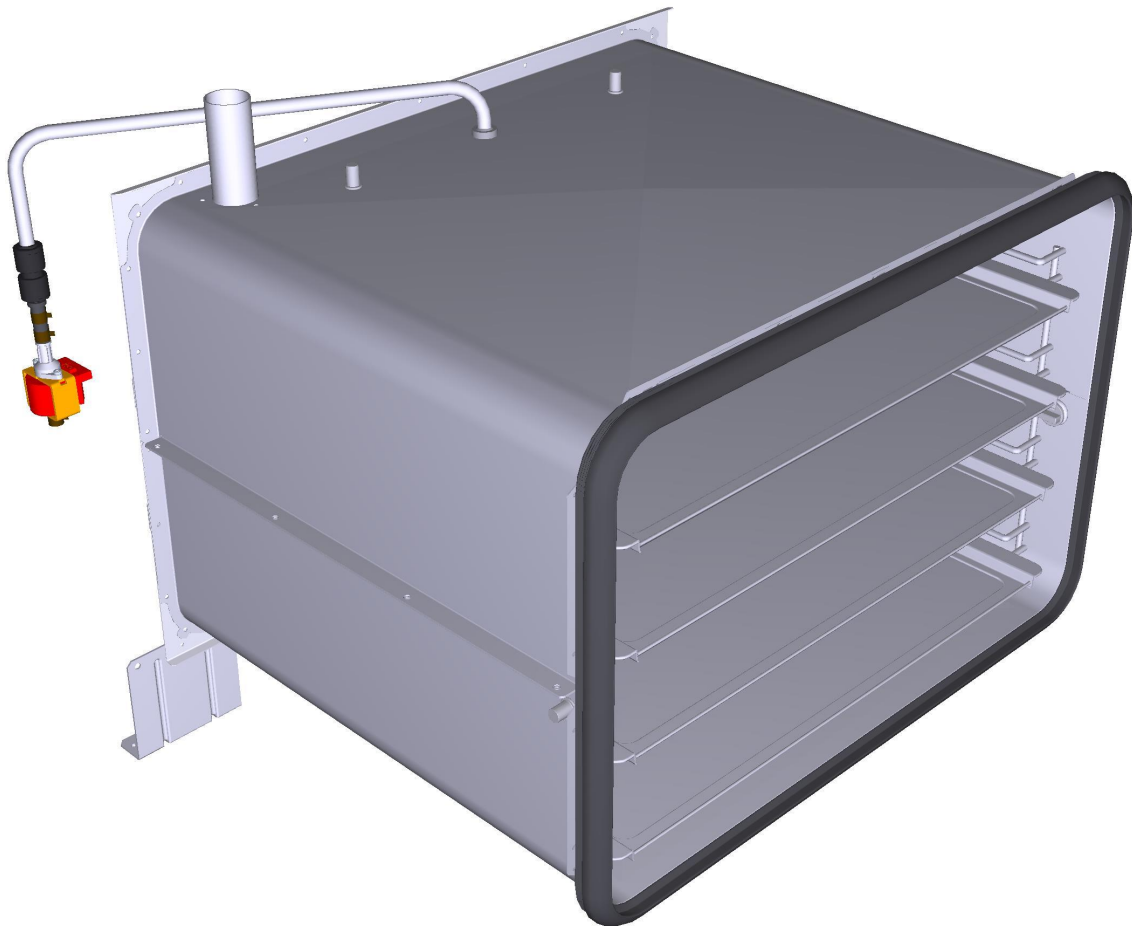

**FRONT**



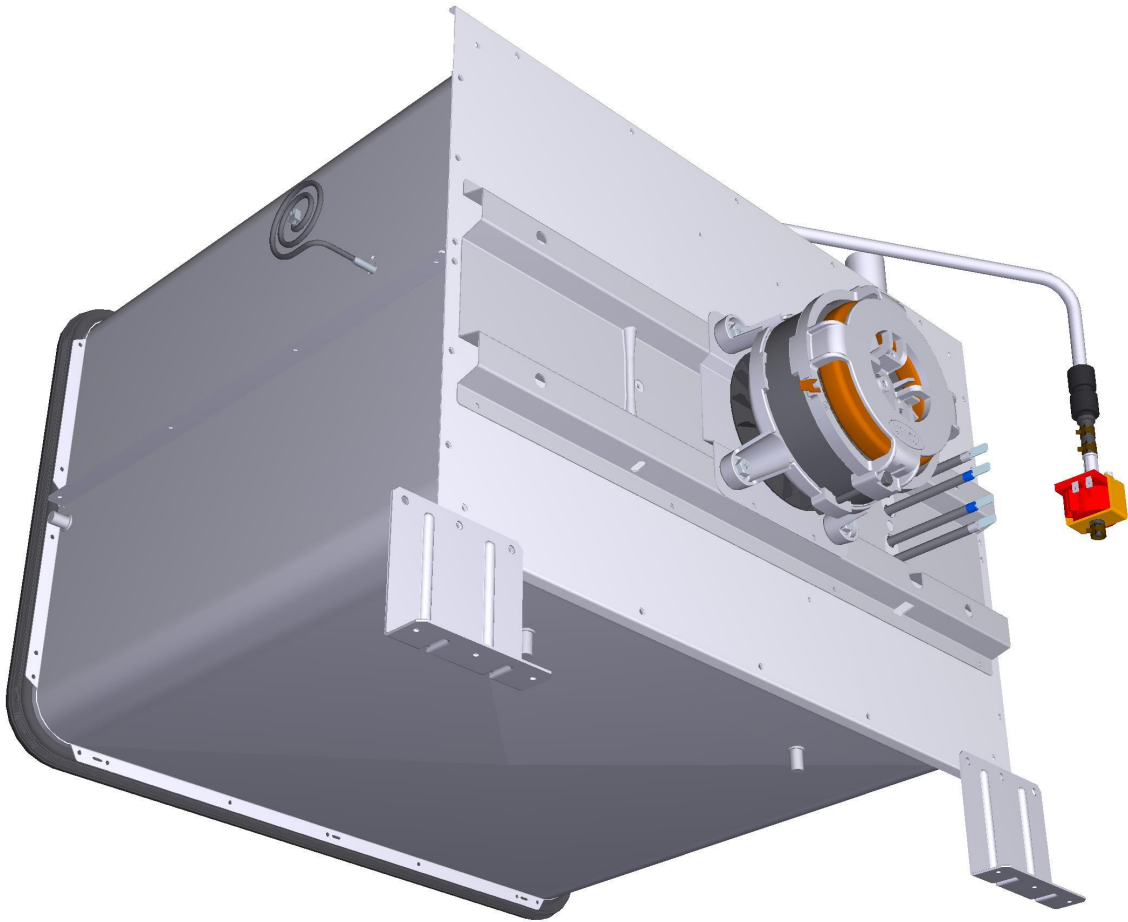

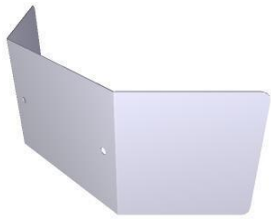

**ASM3402A/0.D02 - Cooking chamber**



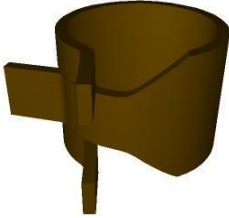

**REAR**



COMPONENT			SPARE PART																																						
Code	Description	Image	Code	Description	Kit components																																				
0C1759A	0C1759A0		0C1759A0	0C1759A0																																					
0G1652B	ARIANNA SP FAN GUARD		K0G1652B	ARIANNA BLSP FAN GUARD + HUMID. PIPE KIT	<table border="1"> <thead> <tr> <th>Code</th> <th>Description</th> <th>Qty</th> <th>UOM</th> </tr> </thead> <tbody> <tr> <td>0G1652B0</td> <td>ARIANNA SP FAN GUARD</td> <td>1.000</td> <td>PC</td> </tr> <tr> <td>TB1578B0</td> <td>ARIANNA SP INTERNAL HUMIDITY PIP</td> <td>1.000</td> <td>PC</td> </tr> <tr> <td>VI1220A1</td> <td>4,2x12 TCB SELF-TAPPIN G SCREW</td> <td>2.000</td> <td>PC</td> </tr> </tbody> </table>	Code	Description	Qty	UOM	0G1652B0	ARIANNA SP FAN GUARD	1.000	PC	TB1578B0	ARIANNA SP INTERNAL HUMIDITY PIP	1.000	PC	VI1220A1	4,2x12 TCB SELF-TAPPIN G SCREW	2.000	PC																				
Code	Description	Qty	UOM																																						
0G1652B0	ARIANNA SP FAN GUARD	1.000	PC																																						
TB1578B0	ARIANNA SP INTERNAL HUMIDITY PIP	1.000	PC																																						
VI1220A1	4,2x12 TCB SELF-TAPPIN G SCREW	2.000	PC																																						
0H7875A	SHOP.PRO MUFFLE SUPPORT BRACKET		0H7875A0	SHOP.PRO MUFFLE SUPPORT BRACKET																																					
TR1105A	L1000 PT100 TEMPERATURE PROBE		KTR1105A	PT100 L1000 TEMPERATURE PROBE KIT	<table border="1"> <thead> <tr> <th>Code</th> <th>Description</th> <th>Qty</th> <th>UOM</th> </tr> </thead> <tbody> <tr> <td>GN1120A1</td> <td>NTC TEMPERATUR E PROBE SEAL</td> <td>1.000</td> <td>PC</td> </tr> <tr> <td>GN1285A0</td> <td>NTC TEMPERATUR E PROBE SEALING</td> <td>1.000</td> <td>PC</td> </tr> <tr> <td>SL1045A0</td> <td>S57 BLACK SILICONE - 80ml CARTRIDGE</td> <td>1.000</td> <td>PC</td> </tr> <tr> <td>TR1105A4</td> <td>L1000 PT100 TEMPERATUR E PROBE</td> <td>1.000</td> <td>PC</td> </tr> <tr> <td>VI1220A1</td> <td>4,2x12 TCB SELF-TAPPIN G SCREW</td> <td>2.000</td> <td>PC</td> </tr> <tr> <td>VM1464A1</td> <td>CT BT TEMPERATUR E PROBE COVER</td> <td>1.000</td> <td>PC</td> </tr> <tr> <td>VM1465A1</td> <td>CT BT TEMPERATUR E PROBE COVER</td> <td>1.000</td> <td>PC</td> </tr> <tr> <td>VM2052A0</td> <td>LM CORE PROBE COVE</td> <td>1.000</td> <td>PC</td> </tr> </tbody> </table>	Code	Description	Qty	UOM	GN1120A1	NTC TEMPERATUR E PROBE SEAL	1.000	PC	GN1285A0	NTC TEMPERATUR E PROBE SEALING	1.000	PC	SL1045A0	S57 BLACK SILICONE - 80ml CARTRIDGE	1.000	PC	TR1105A4	L1000 PT100 TEMPERATUR E PROBE	1.000	PC	VI1220A1	4,2x12 TCB SELF-TAPPIN G SCREW	2.000	PC	VM1464A1	CT BT TEMPERATUR E PROBE COVER	1.000	PC	VM1465A1	CT BT TEMPERATUR E PROBE COVER	1.000	PC	VM2052A0	LM CORE PROBE COVE	1.000	PC
Code	Description	Qty	UOM																																						
GN1120A1	NTC TEMPERATUR E PROBE SEAL	1.000	PC																																						
GN1285A0	NTC TEMPERATUR E PROBE SEALING	1.000	PC																																						
SL1045A0	S57 BLACK SILICONE - 80ml CARTRIDGE	1.000	PC																																						
TR1105A4	L1000 PT100 TEMPERATUR E PROBE	1.000	PC																																						
VI1220A1	4,2x12 TCB SELF-TAPPIN G SCREW	2.000	PC																																						
VM1464A1	CT BT TEMPERATUR E PROBE COVER	1.000	PC																																						
VM1465A1	CT BT TEMPERATUR E PROBE COVER	1.000	PC																																						
VM2052A0	LM CORE PROBE COVE	1.000	PC																																						



COMPONENT			SPARE PART																										
Code	Description	Image	Code	Description	Kit components																								
EL1055A	Ø10 - Ø8 INT. REDUCTION - USE PM201008E		KEL1055A	Ø10-Ø8 JG REDUCTION 10 PCS KIT	<table border="1"> <thead> <tr> <th>Code</th> <th>Description</th> <th>Qty</th> <th>UOM</th> </tr> </thead> <tbody> <tr> <td>EL1055A0</td> <td>Ø10 - Ø8 INT. REDUCTION - USE PM201008</td> <td>10.000</td> <td>PC</td> </tr> </tbody> </table>	Code	Description	Qty	UOM	EL1055A0	Ø10 - Ø8 INT. REDUCTION - USE PM201008	10.000	PC																
Code	Description	Qty	UOM																										
EL1055A0	Ø10 - Ø8 INT. REDUCTION - USE PM201008	10.000	PC																										
PM1015A	PM1015A0		KPM1015A	230-240 V 50HZ 16 W BB6 PUMP KIT	<table border="1"> <thead> <tr> <th>Code</th> <th>Description</th> <th>Qty</th> <th>UOM</th> </tr> </thead> <tbody> <tr> <td>PM1015A0</td> <td>PM1015A0</td> <td>1.000</td> <td>PC</td> </tr> <tr> <td>RC1018A0</td> <td>ZINC PLATED D12 ELASTIC CLAMP</td> <td>2.000</td> <td>PC</td> </tr> <tr> <td>TB3131A0</td> <td>WHITE-BLACK EPDM TEXTILE BRAID HOSE 6x12</td> <td>0.030</td> <td>M</td> </tr> </tbody> </table>	Code	Description	Qty	UOM	PM1015A0	PM1015A0	1.000	PC	RC1018A0	ZINC PLATED D12 ELASTIC CLAMP	2.000	PC	TB3131A0	WHITE-BLACK EPDM TEXTILE BRAID HOSE 6x12	0.030	M								
Code	Description	Qty	UOM																										
PM1015A0	PM1015A0	1.000	PC																										
RC1018A0	ZINC PLATED D12 ELASTIC CLAMP	2.000	PC																										
TB3131A0	WHITE-BLACK EPDM TEXTILE BRAID HOSE 6x12	0.030	M																										
RC1019A	D=10 ELASTIC CLAM		KRC1019A	Ø10 ZINC PLATED ELASTIC CLAMP 15 PCS KIT	<table border="1"> <thead> <tr> <th>Code</th> <th>Description</th> <th>Qty</th> <th>UOM</th> </tr> </thead> <tbody> <tr> <td>RC1019A0</td> <td>D=10 ELASTIC CLAMP</td> <td>15.000</td> <td>PC</td> </tr> </tbody> </table>	Code	Description	Qty	UOM	RC1019A0	D=10 ELASTIC CLAMP	15.000	PC																
Code	Description	Qty	UOM																										
RC1019A0	D=10 ELASTIC CLAMP	15.000	PC																										
TB1652A	TB1652A0		TB1652A0	TB1652A0																									
VL1047A	D6 PIPE HOLDER - D8 J.G. TERMINAL		KVL1047A  KVL0016A	Ø6 PIPE HOLDER+Ø8 JG TERMINAL 10 PCS KIT  BRITA ADAPTOR KIT FOR MM CLEANING SYSTEM	<table border="1"> <thead> <tr> <th>Code</th> <th>Description</th> <th>Qty</th> <th>UOM</th> </tr> </thead> <tbody> <tr> <td>VL1047A1</td> <td>D6 PIPE HOLDER - D8 J.G. TERMINAL</td> <td>10.000</td> <td>PC</td> </tr> </tbody> </table> <table border="1"> <thead> <tr> <th>Code</th> <th>Description</th> <th>Qty</th> <th>UOM</th> </tr> </thead> <tbody> <tr> <td>EL1185A0</td> <td>Ø8F - Ø8F ELBOW CONNECTION</td> <td>260.000</td> <td>PC</td> </tr> <tr> <td>RC1018A0</td> <td>ZINC PLATED D12 ELASTIC CLAMP</td> <td>520.000</td> <td>PC</td> </tr> <tr> <td>VL1047A1</td> <td>D6 PIPE HOLDER - D8 J.G. TERMINAL</td> <td>520.000</td> <td>PC</td> </tr> </tbody> </table>	Code	Description	Qty	UOM	VL1047A1	D6 PIPE HOLDER - D8 J.G. TERMINAL	10.000	PC	Code	Description	Qty	UOM	EL1185A0	Ø8F - Ø8F ELBOW CONNECTION	260.000	PC	RC1018A0	ZINC PLATED D12 ELASTIC CLAMP	520.000	PC	VL1047A1	D6 PIPE HOLDER - D8 J.G. TERMINAL	520.000	PC
Code	Description	Qty	UOM																										
VL1047A1	D6 PIPE HOLDER - D8 J.G. TERMINAL	10.000	PC																										
Code	Description	Qty	UOM																										
EL1185A0	Ø8F - Ø8F ELBOW CONNECTION	260.000	PC																										
RC1018A0	ZINC PLATED D12 ELASTIC CLAMP	520.000	PC																										
VL1047A1	D6 PIPE HOLDER - D8 J.G. TERMINAL	520.000	PC																										



COMPONENT			SPARE PART																														
Code	Description	Image	Code	Description	Kit components																												
0H3020A	MOTOR SHAFT SEALING DISC		0H3020A1	MOTOR SHAFT SEALING DISC																													
0H7170A	MM MOTOR GLASS WOOL PLATE		0H7170A0	MM MOTOR GLASS WOOL PLATE																													
GN1547A	SHAFT GASKET D11.8		KGN1547A	D11.6 MOTOR SHAFT GASKET 3PCS KIT	<table border="1"> <thead> <tr> <th>Code</th> <th>Description</th> <th>Qty</th> <th>UOM</th> </tr> </thead> <tbody> <tr> <td>GN1547A1</td> <td>SHAFT GASKET D11.8</td> <td>3.000</td> <td>PC</td> </tr> </tbody> </table>	Code	Description	Qty	UOM	GN1547A1	SHAFT GASKET D11.8	3.000	PC																				
Code	Description	Qty	UOM																														
GN1547A1	SHAFT GASKET D11.8	3.000	PC																														
MT1012A	330W 230V MOTOR		KVN1130A	LUX ≤08.2017/L.MISS/S.5/ 5E MOTOR KIT	<table border="1"> <thead> <tr> <th>Code</th> <th>Description</th> <th>Qty</th> <th>UOM</th> </tr> </thead> <tbody> <tr> <td>0H4305A1</td> <td>ST. STEEL MOTOR SHAFT SEALING DISC</td> <td>1.000</td> <td>PC</td> </tr> <tr> <td>GN1140A3</td> <td>MOLDED MOTOR HOLDER GASKET</td> <td>1.000</td> <td>PC</td> </tr> <tr> <td>VI1034A0</td> <td>STAINLESS STEEL WASHER 8.4x16x1</td> <td>1.000</td> <td>PC</td> </tr> <tr> <td>VI1256A0</td> <td>M8 DIN 980M ST. STEEL SELF LOCKING NUT</td> <td>1.000</td> <td>PC</td> </tr> <tr> <td>VM2196A0</td> <td>MOTOR NUT FASTENING BUSHING</td> <td>1.000</td> <td>PC</td> </tr> <tr> <td>VN1130A1</td> <td>330W 230V 50/60HZ MOTO</td> <td>1.000</td> <td>PC</td> </tr> </tbody> </table>	Code	Description	Qty	UOM	0H4305A1	ST. STEEL MOTOR SHAFT SEALING DISC	1.000	PC	GN1140A3	MOLDED MOTOR HOLDER GASKET	1.000	PC	VI1034A0	STAINLESS STEEL WASHER 8.4x16x1	1.000	PC	VI1256A0	M8 DIN 980M ST. STEEL SELF LOCKING NUT	1.000	PC	VM2196A0	MOTOR NUT FASTENING BUSHING	1.000	PC	VN1130A1	330W 230V 50/60HZ MOTO	1.000	PC
Code	Description	Qty	UOM																														
0H4305A1	ST. STEEL MOTOR SHAFT SEALING DISC	1.000	PC																														
GN1140A3	MOLDED MOTOR HOLDER GASKET	1.000	PC																														
VI1034A0	STAINLESS STEEL WASHER 8.4x16x1	1.000	PC																														
VI1256A0	M8 DIN 980M ST. STEEL SELF LOCKING NUT	1.000	PC																														
VM2196A0	MOTOR NUT FASTENING BUSHING	1.000	PC																														
VN1130A1	330W 230V 50/60HZ MOTO	1.000	PC																														

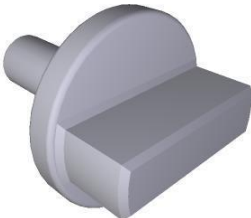
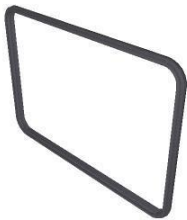
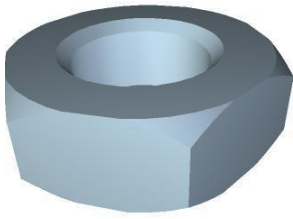

COMPONENT			SPARE PART																																										
Code	Description	Image	Code	Description	Kit components																																								
MT1012A	330W 230V MOTOR		KMT1012A	LUX >08.2017 / MIND.MAPS 330W MOTOR KIT	<table border="1"> <thead> <tr> <th>Code</th> <th>Description</th> <th>Qty</th> <th>UOM</th> </tr> </thead> <tbody> <tr> <td>0H2842A0</td> <td>MT1012 CENTERING JI</td> <td>1.000</td> <td>PC</td> </tr> <tr> <td>0H4305A1</td> <td>ST. STEEL MOTOR SHAFT SEALING DISC</td> <td>1.000</td> <td>PC</td> </tr> <tr> <td>GN1140A3</td> <td>MOLDED MOTOR HOLDER GASKET</td> <td>1.000</td> <td>PC</td> </tr> <tr> <td>MT1012A0</td> <td>330W 230V MOTOR</td> <td>1.000</td> <td>PC</td> </tr> <tr> <td>VE1550A0</td> <td>5X3 MM NEODYMIUM MAGNET</td> <td>1.000</td> <td>PC</td> </tr> <tr> <td>VI1077A1</td> <td>SCREW M6x12 TE INOX</td> <td>1.000</td> <td>PC</td> </tr> <tr> <td>VI1521A0</td> <td>STAINLESS STEEL WASHER D=6 6592</td> <td>1.000</td> <td>PC</td> </tr> <tr> <td>VI1966A0</td> <td>M4X14 FLATHEAD SCREW</td> <td>1.000</td> <td>PC</td> </tr> <tr> <td>VM1635A0</td> <td>MAGNET HOLDING DIS</td> <td>1.000</td> <td>PC</td> </tr> </tbody> </table>	Code	Description	Qty	UOM	0H2842A0	MT1012 CENTERING JI	1.000	PC	0H4305A1	ST. STEEL MOTOR SHAFT SEALING DISC	1.000	PC	GN1140A3	MOLDED MOTOR HOLDER GASKET	1.000	PC	MT1012A0	330W 230V MOTOR	1.000	PC	VE1550A0	5X3 MM NEODYMIUM MAGNET	1.000	PC	VI1077A1	SCREW M6x12 TE INOX	1.000	PC	VI1521A0	STAINLESS STEEL WASHER D=6 6592	1.000	PC	VI1966A0	M4X14 FLATHEAD SCREW	1.000	PC	VM1635A0	MAGNET HOLDING DIS	1.000	PC
					Code	Description	Qty	UOM																																					
					0H2842A0	MT1012 CENTERING JI	1.000	PC																																					
					0H4305A1	ST. STEEL MOTOR SHAFT SEALING DISC	1.000	PC																																					
					GN1140A3	MOLDED MOTOR HOLDER GASKET	1.000	PC																																					
					MT1012A0	330W 230V MOTOR	1.000	PC																																					
					VE1550A0	5X3 MM NEODYMIUM MAGNET	1.000	PC																																					
					VI1077A1	SCREW M6x12 TE INOX	1.000	PC																																					
					VI1521A0	STAINLESS STEEL WASHER D=6 6592	1.000	PC																																					
					VI1966A0	M4X14 FLATHEAD SCREW	1.000	PC																																					
VM1635A0	MAGNET HOLDING DIS	1.000	PC																																										
VN1172A	M8 NUT 8 BLADES H40 D195 FAN		KVN1172A	D195 H40 M8 NUT 8 BLADES FAN KIT	<table border="1"> <thead> <tr> <th>Code</th> <th>Description</th> <th>Qty</th> <th>UOM</th> </tr> </thead> <tbody> <tr> <td>VI1077A1</td> <td>SCREW M6x12 TE INOX</td> <td>1.000</td> <td>PC</td> </tr> <tr> <td>VI1521A0</td> <td>STAINLESS STEEL WASHER D=6 6592</td> <td>1.000</td> <td>PC</td> </tr> <tr> <td>VN1172A0</td> <td>M8 NUT 8 BLADES H40 D195 FAN</td> <td>1.000</td> <td>PC</td> </tr> </tbody> </table>	Code	Description	Qty	UOM	VI1077A1	SCREW M6x12 TE INOX	1.000	PC	VI1521A0	STAINLESS STEEL WASHER D=6 6592	1.000	PC	VN1172A0	M8 NUT 8 BLADES H40 D195 FAN	1.000	PC																								
					Code	Description	Qty	UOM																																					
					VI1077A1	SCREW M6x12 TE INOX	1.000	PC																																					
VI1521A0	STAINLESS STEEL WASHER D=6 6592	1.000	PC																																										
VN1172A0	M8 NUT 8 BLADES H40 D195 FAN	1.000	PC																																										
RS1283A	RS1283A0		KRS1283A	4TURN 3200W 230V+210W 160V HEAT ELEM KIT	<table border="1"> <thead> <tr> <th>Code</th> <th>Description</th> <th>Qty</th> <th>UOM</th> </tr> </thead> <tbody> <tr> <td>GN1327A0</td> <td>HEATING ELEMENT GASKET</td> <td>1.000</td> <td>PC</td> </tr> <tr> <td>RS1283A0</td> <td>RS1283A0</td> <td>1.000</td> <td>PC</td> </tr> <tr> <td>SL1045A0</td> <td>S57 BLACK SILICONE - 80ml CARTRIDGE</td> <td>1.000</td> <td>PC</td> </tr> <tr> <td>VI1220A1</td> <td>4,2x12 TCB SELF-TAPPIN G SCREW</td> <td>2.000</td> <td>PC</td> </tr> </tbody> </table>	Code	Description	Qty	UOM	GN1327A0	HEATING ELEMENT GASKET	1.000	PC	RS1283A0	RS1283A0	1.000	PC	SL1045A0	S57 BLACK SILICONE - 80ml CARTRIDGE	1.000	PC	VI1220A1	4,2x12 TCB SELF-TAPPIN G SCREW	2.000	PC																				
					Code	Description	Qty	UOM																																					
					GN1327A0	HEATING ELEMENT GASKET	1.000	PC																																					
RS1283A0	RS1283A0	1.000	PC																																										
SL1045A0	S57 BLACK SILICONE - 80ml CARTRIDGE	1.000	PC																																										
VI1220A1	4,2x12 TCB SELF-TAPPIN G SCREW	2.000	PC																																										



COMPONENT			SPARE PART										
Code	Description	Image	Code	Description	Kit components								
GRL1010A	Arianna LineMiss RIGHT/LEFT LATERAL GRID		KGRL1010A	R/L CHROM. PLATED LATERAL SUPP KIT	<table border="1"> <thead> <tr> <th>Code</th> <th>Description</th> <th>Qty</th> <th>UOM</th> </tr> </thead> <tbody> <tr> <td>GRL1010A2</td> <td>Arianna LineMiss RIGHT/LEFT LATERAL GRID</td> <td>2.000</td> <td>PC</td> </tr> </tbody> </table>	Code	Description	Qty	UOM	GRL1010A2	Arianna LineMiss RIGHT/LEFT LATERAL GRID	2.000	PC
Code	Description	Qty	UOM										
GRL1010A2	Arianna LineMiss RIGHT/LEFT LATERAL GRID	2.000	PC										
VM1815A	LATERAL SUPPORTS FIXING BOLT		KVM1815A	MISS/MICRO/S4/S3 THUMB SCREW 10 PCS KIT	<table border="1"> <thead> <tr> <th>Code</th> <th>Description</th> <th>Qty</th> <th>UOM</th> </tr> </thead> <tbody> <tr> <td>VM1815A0</td> <td>LATERAL SUPPORTS FIXING BOLT</td> <td>10.000</td> <td>PC</td> </tr> </tbody> </table>	Code	Description	Qty	UOM	VM1815A0	LATERAL SUPPORTS FIXING BOLT	10.000	PC
Code	Description	Qty	UOM										
VM1815A0	LATERAL SUPPORTS FIXING BOLT	10.000	PC										
GN1352A	L.M. TOUCH ARIANNA DOOR GASKET - GN1110A		KGN1352A	LM ARIANNA/BT CABINET DOOR GASKET KIT	<table border="1"> <thead> <tr> <th>Code</th> <th>Description</th> <th>Qty</th> <th>UOM</th> </tr> </thead> <tbody> <tr> <td>GN1110A2</td> <td>Line Miss/XVC105-0 55/XK/XL DOOR GASKE</td> <td>1.650</td> <td>M</td> </tr> </tbody> </table>	Code	Description	Qty	UOM	GN1110A2	Line Miss/XVC105-0 55/XK/XL DOOR GASKE	1.650	M
Code	Description	Qty	UOM										
GN1110A2	Line Miss/XVC105-0 55/XK/XL DOOR GASKE	1.650	M										
RC1170A	M14 H=7 CH=22 STAINLESS STEEL NUT		KRC1170A	M14 H8 CH22 NUT - 10 PCS. KIT	<table border="1"> <thead> <tr> <th>Code</th> <th>Description</th> <th>Qty</th> <th>UOM</th> </tr> </thead> <tbody> <tr> <td>RC1170A1</td> <td>M14 H=7 CH=22 STAINLESS STEEL NUT</td> <td>10.000</td> <td>PC</td> </tr> </tbody> </table>	Code	Description	Qty	UOM	RC1170A1	M14 H=7 CH=22 STAINLESS STEEL NUT	10.000	PC
Code	Description	Qty	UOM										
RC1170A1	M14 H=7 CH=22 STAINLESS STEEL NUT	10.000	PC										
TB1568A	ARI-STE-ROS SP WELDED EXT HUMIDITY PIPE		TB1568A0	ARI-STE-ROS SP WELDED EXT HUMIDITY PIPE									





COMPONENT			SPARE PART		
Code	Description	Image	Code	Description	Kit components
TB1574A	FUME CHIMNEY D30 SHOP PRO		TB1574A0	FUME CHIMNEY D30 SHOP PRO	
TB1578B	ARIANNA SP INTERNAL HUMIDITY PIPE		TB1578B0	ARIANNA SP INTERNAL HUMIDITY PIPE	



**ASM3414A/0.D01 - External cover**

**FRONT**

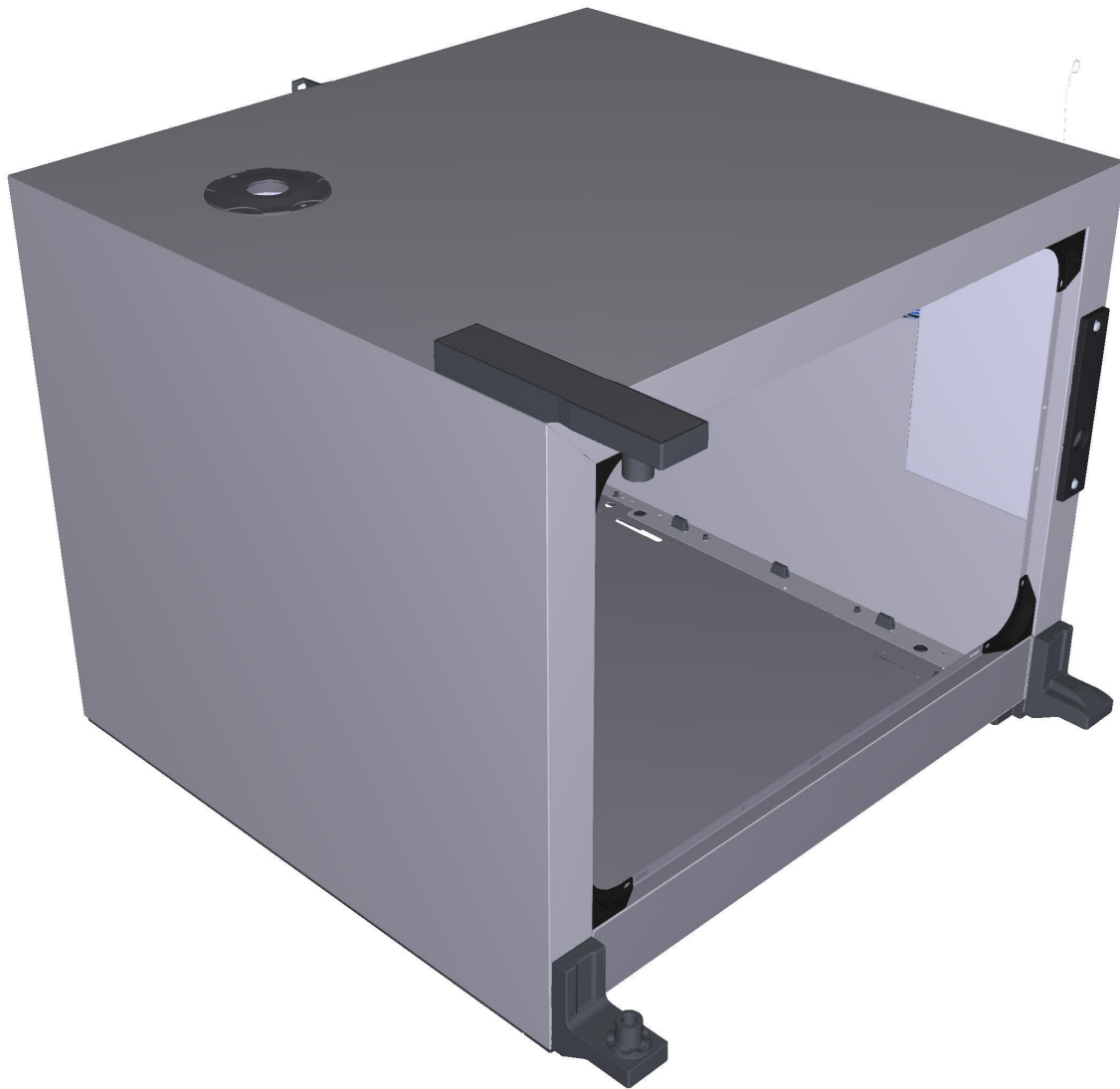



**ASM3414A/0.D01 - External cover**



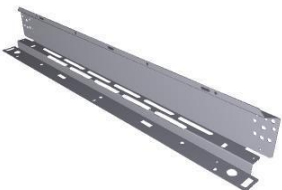
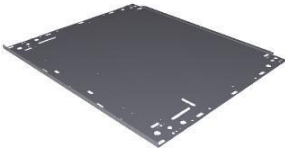

**REAR**







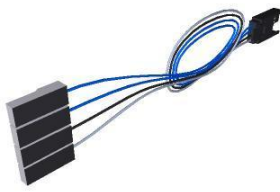

COMPONENT			SPARE PART		
Code	Description	Image	Code	Description	Kit components
0D2407B	ARIANNA SP RIGHT TO LEFT EXT CASIN		0D2407B0	ARIANNA SP RIGHT TO LEFT EXT CASIN	
0D2410A	SP600 INF FRONT PROFILE RIGHT-LEFT DOOR		0D2410A0	SP600 INF FRONT PROFILE RIGHT-LEFT DOOR	
0E1381A	SP600 EXTERNAL BOTTOM PANEL		0E1381A1	SP 460X330 LAT BOTT PANEL GASKET 2PC KIT	
0F1542B	ARIANNA SP BACK PANEL		0F1542B0	ARIANNA SP BACK PANEL	
0H7992A	0H7992A0		0H7992A0	0H7992A0	





COMPONENT			SPARE PART																																		
Code	Description	Image	Code	Description	Kit components																																
VM1750A	BRASS COMB CLAMP		KVM1750A	COMB TERMINAL BLOCK KIT	<table border="1"> <thead> <tr> <th>Code</th> <th>Description</th> <th>Qty</th> <th>UOM</th> </tr> </thead> <tbody> <tr> <td>VI1040A0</td> <td>INDENTED INTERNAL WASHER D=6 ZN</td> <td>2.000</td> <td>PC</td> </tr> <tr> <td>VM1750A0</td> <td>BRASS COMB CLAMP</td> <td>1.000</td> <td>PC</td> </tr> </tbody> </table>	Code	Description	Qty	UOM	VI1040A0	INDENTED INTERNAL WASHER D=6 ZN	2.000	PC	VM1750A0	BRASS COMB CLAMP	1.000	PC																				
					Code	Description	Qty	UOM																													
VI1040A0	INDENTED INTERNAL WASHER D=6 ZN	2.000	PC																																		
VM1750A0	BRASS COMB CLAMP	1.000	PC																																		
OH1234A	DOOR LOCK HOLDING PLATE		KVM2154A K0H1234A	LINEMISS MATIC-TOP LOCKING COVER KI SHOP.PRO LOCK HOLDING PLATE KIT	<table border="1"> <thead> <tr> <th>Code</th> <th>Description</th> <th>Qty</th> <th>UOM</th> </tr> </thead> <tbody> <tr> <td>OH1234A2</td> <td></td> <td>1.000</td> <td>PC</td> </tr> <tr> <td>VM2154A2</td> <td></td> <td>1.000</td> <td>PC</td> </tr> </tbody> </table> <table border="1"> <thead> <tr> <th>Code</th> <th>Description</th> <th>Qty</th> <th>UOM</th> </tr> </thead> <tbody> <tr> <td>OH1234A2</td> <td></td> <td>1.000</td> <td>PC</td> </tr> <tr> <td>VI1014A0</td> <td>STAINLESS STEEL WASHER 4.5X9X0.8</td> <td>2.000</td> <td>PC</td> </tr> <tr> <td>VI1024A0</td> <td>SCREW M4x12 TCB + INOX DIN 7985</td> <td>2.000</td> <td>PC</td> </tr> <tr> <td>VI1850A0</td> <td>TCB M4x6 SCREW</td> <td>2.000</td> <td>PC</td> </tr> </tbody> </table>	Code	Description	Qty	UOM	OH1234A2		1.000	PC	VM2154A2		1.000	PC	Code	Description	Qty	UOM	OH1234A2		1.000	PC	VI1014A0	STAINLESS STEEL WASHER 4.5X9X0.8	2.000	PC	VI1024A0	SCREW M4x12 TCB + INOX DIN 7985	2.000	PC	VI1850A0	TCB M4x6 SCREW	2.000	PC
Code	Description	Qty	UOM																																		
OH1234A2		1.000	PC																																		
VM2154A2		1.000	PC																																		
Code	Description	Qty	UOM																																		
OH1234A2		1.000	PC																																		
VI1014A0	STAINLESS STEEL WASHER 4.5X9X0.8	2.000	PC																																		
VI1024A0	SCREW M4x12 TCB + INOX DIN 7985	2.000	PC																																		
VI1850A0	TCB M4x6 SCREW	2.000	PC																																		
CE1297A	BLSP ELECTROMECHANICAL LOCK CABLE		KCE1297A	BL SHOP.PRO CABLE LOCK KIT	<table border="1"> <thead> <tr> <th>Code</th> <th>Description</th> <th>Qty</th> <th>UOM</th> </tr> </thead> <tbody> <tr> <td>CE1295A1</td> <td>CABLE FOR ELECTROMAGNETIC LOCKING SYSTEM</td> <td>1.000</td> <td>PC</td> </tr> <tr> <td>CE1735A0</td> <td>MINIFIT FEMALE END FITTING</td> <td>4.000</td> <td>PC</td> </tr> <tr> <td>CE1746A0</td> <td>2 WAYS MALE MINIFIT CONNECTOR</td> <td>1.000</td> <td>PC</td> </tr> <tr> <td>CE1750A0</td> <td>3 WAYS MALE MINIFIT CONNECTOR</td> <td>1.000</td> <td>PC</td> </tr> </tbody> </table>	Code	Description	Qty	UOM	CE1295A1	CABLE FOR ELECTROMAGNETIC LOCKING SYSTEM	1.000	PC	CE1735A0	MINIFIT FEMALE END FITTING	4.000	PC	CE1746A0	2 WAYS MALE MINIFIT CONNECTOR	1.000	PC	CE1750A0	3 WAYS MALE MINIFIT CONNECTOR	1.000	PC												
					Code	Description	Qty	UOM																													
					CE1295A1	CABLE FOR ELECTROMAGNETIC LOCKING SYSTEM	1.000	PC																													
					CE1735A0	MINIFIT FEMALE END FITTING	4.000	PC																													
CE1746A0	2 WAYS MALE MINIFIT CONNECTOR	1.000	PC																																		
CE1750A0	3 WAYS MALE MINIFIT CONNECTOR	1.000	PC																																		
CR1035A	L.Miss Matic ELECTROMECHANICAL LOCK		KCR1035A	LM MATIC ELECTROMECHANICAL LOCK KIT	<table border="1"> <thead> <tr> <th>Code</th> <th>Description</th> <th>Qty</th> <th>UOM</th> </tr> </thead> <tbody> <tr> <td>CR1035A0</td> <td>L.Miss Matic ELECTROMECHANICAL LOCK</td> <td>1.000</td> <td>PC</td> </tr> </tbody> </table>	Code	Description	Qty	UOM	CR1035A0	L.Miss Matic ELECTROMECHANICAL LOCK	1.000	PC																								
Code	Description	Qty	UOM																																		
CR1035A0	L.Miss Matic ELECTROMECHANICAL LOCK	1.000	PC																																		





COMPONENT			SPARE PART														
Code	Description	Image	Code	Description	Kit components												
VM2154A	ELECTRIC LOCKING COVER		KVM2154A	LINEMISS MATIC-TOP LOCKING COVER KI	<table border="1"> <thead> <tr> <th>Code</th> <th>Description</th> <th>Qty</th> <th>UOM</th> </tr> </thead> <tbody> <tr> <td>0H1234A2</td> <td></td> <td>1.000</td> <td>PC</td> </tr> <tr> <td>VM2154A2</td> <td></td> <td>1.000</td> <td>PC</td> </tr> </tbody> </table>	Code	Description	Qty	UOM	0H1234A2		1.000	PC	VM2154A2		1.000	PC
Code	Description	Qty	UOM														
0H1234A2		1.000	PC														
VM2154A2		1.000	PC														
VM2502A	BAKERLUX SHOP.PRO CHIMNEY RING		KVM2502A	BAKERLUX SHOP.PRO CHIMNEY RING KIT	<table border="1"> <thead> <tr> <th>Code</th> <th>Description</th> <th>Qty</th> <th>UOM</th> </tr> </thead> <tbody> <tr> <td>VM2502A0</td> <td>BAKERLUX SHOP.PRO CHIMNEY RIN</td> <td>1.000</td> <td>PC</td> </tr> </tbody> </table>	Code	Description	Qty	UOM	VM2502A0	BAKERLUX SHOP.PRO CHIMNEY RIN	1.000	PC				
Code	Description	Qty	UOM														
VM2502A0	BAKERLUX SHOP.PRO CHIMNEY RIN	1.000	PC														
VM2495A	SP COOLING FAN SUPPORT		KVM2495A	COOLING FAN SUPPORT KIT	<table border="1"> <thead> <tr> <th>Code</th> <th>Description</th> <th>Qty</th> <th>UOM</th> </tr> </thead> <tbody> <tr> <td>VI1220A1</td> <td>4,2x12 TCB SELF-TAPPIN G.SCREW</td> <td>2.000</td> <td>PC</td> </tr> <tr> <td>VM2495A0</td> <td>SP COOLING FAN SUPPORT</td> <td>1.000</td> <td>PC</td> </tr> </tbody> </table>	Code	Description	Qty	UOM	VI1220A1	4,2x12 TCB SELF-TAPPIN G.SCREW	2.000	PC	VM2495A0	SP COOLING FAN SUPPORT	1.000	PC
Code	Description	Qty	UOM														
VI1220A1	4,2x12 TCB SELF-TAPPIN G.SCREW	2.000	PC														
VM2495A0	SP COOLING FAN SUPPORT	1.000	PC														
VN1175A	230V 50/60Hz 120x120 COOLING DOWN FAN		KVN1175A	120x120 230V 50/60Hz COOLING FAN KIT	<table border="1"> <thead> <tr> <th>Code</th> <th>Description</th> <th>Qty</th> <th>UOM</th> </tr> </thead> <tbody> <tr> <td>VN1175A0</td> <td>230V 50/60Hz 120x120 COOLING DOWN FAN</td> <td>1.000</td> <td>PC</td> </tr> </tbody> </table>	Code	Description	Qty	UOM	VN1175A0	230V 50/60Hz 120x120 COOLING DOWN FAN	1.000	PC				
Code	Description	Qty	UOM														
VN1175A0	230V 50/60Hz 120x120 COOLING DOWN FAN	1.000	PC														
VM2481A	FRONT EXTERNAL COVER LEFT CAP S		KVM2481A	BL SP LEFT EXT COVER FRONT PANEL CAP KIT	<table border="1"> <thead> <tr> <th>Code</th> <th>Description</th> <th>Qty</th> <th>UOM</th> </tr> </thead> <tbody> <tr> <td>VM2481A0</td> <td>FRONT EXTERNAL COVER LEFT CAP SP</td> <td>1.000</td> <td>PC</td> </tr> </tbody> </table>	Code	Description	Qty	UOM	VM2481A0	FRONT EXTERNAL COVER LEFT CAP SP	1.000	PC				
Code	Description	Qty	UOM														
VM2481A0	FRONT EXTERNAL COVER LEFT CAP SP	1.000	PC														



COMPONENT			SPARE PART																						
Code	Description	Image	Code	Description	Kit components																				
VM2480A	FRONT EXTERNAL COVER RIGHT CAP SP		KVM2480A	BL SP RIGHT EXT COVER FRONT PANEL CAP	<table border="1"> <thead> <tr> <th>Code</th> <th>Description</th> <th>Qty</th> <th>UOM</th> </tr> </thead> <tbody> <tr> <td>VM2480A0</td> <td>FRONT EXTERNAL COVER RIGHT CAP SP</td> <td>1.000</td> <td>PC</td> </tr> </tbody> </table>	Code	Description	Qty	UOM	VM2480A0	FRONT EXTERNAL COVER RIGHT CAP SP	1.000	PC												
Code	Description	Qty	UOM																						
VM2480A0	FRONT EXTERNAL COVER RIGHT CAP SP	1.000	PC																						
VM2488A	BL SHOP.PRO MANUAL UNLOCK SYSTEM		KVM2488A	BL SHOP.PRO MANUAL UNLOCK SYSTEM KIT	<table border="1"> <thead> <tr> <th>Code</th> <th>Description</th> <th>Qty</th> <th>UOM</th> </tr> </thead> <tbody> <tr> <td>VI1220A1</td> <td>4,2x12 TCB SELF-TAPPIN G SCREW</td> <td>2.000</td> <td>PC</td> </tr> <tr> <td>VI1950A0</td> <td>ST. STEEL 4,2X13 TCB SELF-DRILLIN G SCREW</td> <td>2.000</td> <td>PC</td> </tr> <tr> <td>VM2488A1</td> <td>BL SHOP.PRO MANUAL UNLOCK SYSTEM</td> <td>1.000</td> <td>PC</td> </tr> <tr> <td>VM2501A0</td> <td>BL SHOP.PRO UNLOCK SCREW</td> <td>1.000</td> <td>PC</td> </tr> </tbody> </table>	Code	Description	Qty	UOM	VI1220A1	4,2x12 TCB SELF-TAPPIN G SCREW	2.000	PC	VI1950A0	ST. STEEL 4,2X13 TCB SELF-DRILLIN G SCREW	2.000	PC	VM2488A1	BL SHOP.PRO MANUAL UNLOCK SYSTEM	1.000	PC	VM2501A0	BL SHOP.PRO UNLOCK SCREW	1.000	PC
Code	Description	Qty	UOM																						
VI1220A1	4,2x12 TCB SELF-TAPPIN G SCREW	2.000	PC																						
VI1950A0	ST. STEEL 4,2X13 TCB SELF-DRILLIN G SCREW	2.000	PC																						
VM2488A1	BL SHOP.PRO MANUAL UNLOCK SYSTEM	1.000	PC																						
VM2501A0	BL SHOP.PRO UNLOCK SCREW	1.000	PC																						
0H7850A	SHOP PRO DOOR COUNTERBRACKET		0H7850A0	SHOP PRO DOOR COUNTERBRACKET																					
VI0515A	STAINLESS STEEL WASHER D=5 6592		VI0515A0	STAINLESS STEEL WASHER D=5 6592																					

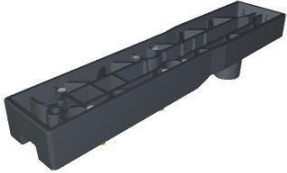

COMPONENT			SPARE PART																						
Code	Description	Image	Code	Description	Kit components																				
VI1995A	M5x25 ST.STEEL SCREW		VI1995A0	M5x25 ST.STEEL SCREW																					
VM1240A	NYLON SUPPORT CAP		KVM1240A	4 PCS COUNTER BRACKET SUPPORT CAP KIT	<table border="1"> <thead> <tr> <th>Code</th> <th>Description</th> <th>Qty</th> <th>UOM</th> </tr> </thead> <tbody> <tr> <td>VM1240A0</td> <td>NYLON SUPPORT CAP</td> <td>4.000</td> <td>PC</td> </tr> </tbody> </table>	Code	Description	Qty	UOM	VM1240A0	NYLON SUPPORT CAP	4.000	PC												
Code	Description	Qty	UOM																						
VM1240A0	NYLON SUPPORT CAP	4.000	PC																						
VM2459A	SP LATERAL DOOR UPPER BRACKET		KVM2459A	BL SP LATERAL DOOR UPPER BRACKET KIT	<table border="1"> <thead> <tr> <th>Code</th> <th>Description</th> <th>Qty</th> <th>UOM</th> </tr> </thead> <tbody> <tr> <td>VI0515A0</td> <td>STAINLESS STEEL WASHER D=5 6592</td> <td>4.000</td> <td>PC</td> </tr> <tr> <td>VI1995A0</td> <td>M5x25 ST.STEEL SCREW</td> <td>4.000</td> <td>PC</td> </tr> <tr> <td>VM2459A1</td> <td>SP LATERAL DOOR UPPER BRACKET</td> <td>1.000</td> <td>PC</td> </tr> <tr> <td>VM2460A0</td> <td>BL SP LATERAL DOOR UPPER BRACKET COVER</td> <td>1.000</td> <td>PC</td> </tr> </tbody> </table>	Code	Description	Qty	UOM	VI0515A0	STAINLESS STEEL WASHER D=5 6592	4.000	PC	VI1995A0	M5x25 ST.STEEL SCREW	4.000	PC	VM2459A1	SP LATERAL DOOR UPPER BRACKET	1.000	PC	VM2460A0	BL SP LATERAL DOOR UPPER BRACKET COVER	1.000	PC
Code	Description	Qty	UOM																						
VI0515A0	STAINLESS STEEL WASHER D=5 6592	4.000	PC																						
VI1995A0	M5x25 ST.STEEL SCREW	4.000	PC																						
VM2459A1	SP LATERAL DOOR UPPER BRACKET	1.000	PC																						
VM2460A0	BL SP LATERAL DOOR UPPER BRACKET COVER	1.000	PC																						
VM2460A	BL SP LATERAL DOOR UPPER BRACKET COVER		KVM2460A	BL SP LAT DOOR UPP BRACKET COVER 2PC KIT	<table border="1"> <thead> <tr> <th>Code</th> <th>Description</th> <th>Qty</th> <th>UOM</th> </tr> </thead> <tbody> <tr> <td>VM2460A0</td> <td>BL SP LATERAL DOOR UPPER BRACKET COVER</td> <td>1.000</td> <td>PC</td> </tr> </tbody> </table>	Code	Description	Qty	UOM	VM2460A0	BL SP LATERAL DOOR UPPER BRACKET COVER	1.000	PC												
Code	Description	Qty	UOM																						
VM2460A0	BL SP LATERAL DOOR UPPER BRACKET COVER	1.000	PC																						









COMPONENT			SPARE PART																						
Code	Description	Image	Code	Description	Kit components																				
0H7850A	SHOP PRO DOOR COUNTERBRACKET		0H7850A0	SHOP PRO DOOR COUNTERBRACKET																					
VI0515A	STAINLESS STEEL WASHER D=5 6592		VI0515A0	STAINLESS STEEL WASHER D=5 6592																					
VI1995A	M5x25 ST.STEEL SCREW		VI1995A0	M5x25 ST.STEEL SCREW																					
VM1240A	NYLON SUPPORT CAP		KVM1240A	4 PCS COUNTER BRACKET SUPPORT CAP KIT	<table border="1"> <thead> <tr> <th>Code</th> <th>Description</th> <th>Qty</th> <th>UOM</th> </tr> </thead> <tbody> <tr> <td>VM1240A0</td> <td>NYLON SUPPORT CAP</td> <td>4.000</td> <td>PC</td> </tr> </tbody> </table>	Code	Description	Qty	UOM	VM1240A0	NYLON SUPPORT CAP	4.000	PC												
Code	Description	Qty	UOM																						
VM1240A0	NYLON SUPPORT CAP	4.000	PC																						
VM2457A	BL SP LATERAL DOOR LOWER BRACKET		KVM2457A	BL SP LATERAL DOOR LOWER BRACKET KIT	<table border="1"> <thead> <tr> <th>Code</th> <th>Description</th> <th>Qty</th> <th>UOM</th> </tr> </thead> <tbody> <tr> <td>VI0515A0</td> <td>STAINLESS STEEL WASHER D=5 6592</td> <td>2.000</td> <td>PC</td> </tr> <tr> <td>VI1995A0</td> <td>M5x25 ST.STEEL SCREW</td> <td>2.000</td> <td>PC</td> </tr> <tr> <td>VM2457A0</td> <td>BL SP LATERAL DOOR LOWER BRACKET</td> <td>1.000</td> <td>PC</td> </tr> <tr> <td>VM2458A0</td> <td>BL SP LATERAL DOOR LOW BRACKET COVER</td> <td>1.000</td> <td>PC</td> </tr> </tbody> </table>	Code	Description	Qty	UOM	VI0515A0	STAINLESS STEEL WASHER D=5 6592	2.000	PC	VI1995A0	M5x25 ST.STEEL SCREW	2.000	PC	VM2457A0	BL SP LATERAL DOOR LOWER BRACKET	1.000	PC	VM2458A0	BL SP LATERAL DOOR LOW BRACKET COVER	1.000	PC
Code	Description	Qty	UOM																						
VI0515A0	STAINLESS STEEL WASHER D=5 6592	2.000	PC																						
VI1995A0	M5x25 ST.STEEL SCREW	2.000	PC																						
VM2457A0	BL SP LATERAL DOOR LOWER BRACKET	1.000	PC																						
VM2458A0	BL SP LATERAL DOOR LOW BRACKET COVER	1.000	PC																						





COMPONENT			SPARE PART										
Code	Description	Image	Code	Description	Kit components								
VM2458A	BL SP LATERAL DOOR LOW BRACKET COVER		KVM2458A	BL SP LAT DOOR LOW BRACKET COVER 2PC KIT	<table border="1"> <thead> <tr> <th>Code</th> <th>Description</th> <th>Qty</th> <th>UOM</th> </tr> </thead> <tbody> <tr> <td>VM2458A0</td> <td>BL SP LATERAL DOOR LOW BRACKET COVER</td> <td>2.000</td> <td>PC</td> </tr> </tbody> </table>	Code	Description	Qty	UOM	VM2458A0	BL SP LATERAL DOOR LOW BRACKET COVER	2.000	PC
Code	Description	Qty	UOM										
VM2458A0	BL SP LATERAL DOOR LOW BRACKET COVER	2.000	PC										
0H7850A	SHOP PRO DOOR COUNTERBRACKET		0H7850A0	SHOP PRO DOOR COUNTERBRACKET									
VI0515A	STAINLESS STEEL WASHER D=5 6592		VI0515A0	STAINLESS STEEL WASHER D=5 6592									
VI1995A	M5x25 ST.STEEL SCREW		VI1995A0	M5x25 ST.STEEL SCREW									
VM1240A	NYLON SUPPORT CAP		KVM1240A	4 PCS COUNTER BRACKET SUPPORT CAP KIT	<table border="1"> <thead> <tr> <th>Code</th> <th>Description</th> <th>Qty</th> <th>UOM</th> </tr> </thead> <tbody> <tr> <td>VM1240A0</td> <td>NYLON SUPPORT CAP</td> <td>4.000</td> <td>PC</td> </tr> </tbody> </table>	Code	Description	Qty	UOM	VM1240A0	NYLON SUPPORT CAP	4.000	PC
Code	Description	Qty	UOM										
VM1240A0	NYLON SUPPORT CAP	4.000	PC										



COMPONENT			SPARE PART																						
Code	Description	Image	Code	Description	Kit components																				
VM2458A	BL SP LATERAL DOOR LOW BRACKET COVER		KVM2458A	BL SP LAT DOOR LOW BRACKET COVER 2PC KIT	<table border="1"> <thead> <tr> <th>Code</th> <th>Description</th> <th>Qty</th> <th>UOM</th> </tr> </thead> <tbody> <tr> <td>VM2458A0</td> <td>BL SP LATERAL DOOR LOW BRACKET COVER</td> <td>2.000</td> <td>PC</td> </tr> </tbody> </table>	Code	Description	Qty	UOM	VM2458A0	BL SP LATERAL DOOR LOW BRACKET COVER	2.000	PC												
Code	Description	Qty	UOM																						
VM2458A0	BL SP LATERAL DOOR LOW BRACKET COVER	2.000	PC																						
VM2469A	BL SP LATERAL DOOR HOLDER BRACKET		KVM2469A	BL SP LATERAL DOOR HOLDER BRACKET KIT	<table border="1"> <thead> <tr> <th>Code</th> <th>Description</th> <th>Qty</th> <th>UOM</th> </tr> </thead> <tbody> <tr> <td>VI0515A0</td> <td>STAINLESS STEEL WASHER D=5 6592</td> <td>2.000</td> <td>PC</td> </tr> <tr> <td>VI1995A0</td> <td>M5x25 ST.STEEL SCREW</td> <td>2.000</td> <td>PC</td> </tr> <tr> <td>VM2458A0</td> <td>BL SP LATERAL DOOR LOW BRACKET COVER</td> <td>1.000</td> <td>PC</td> </tr> <tr> <td>VM2469A0</td> <td>BL SP LATERAL DOOR HOLDER BRACKET</td> <td>1.000</td> <td>PC</td> </tr> </tbody> </table>	Code	Description	Qty	UOM	VI0515A0	STAINLESS STEEL WASHER D=5 6592	2.000	PC	VI1995A0	M5x25 ST.STEEL SCREW	2.000	PC	VM2458A0	BL SP LATERAL DOOR LOW BRACKET COVER	1.000	PC	VM2469A0	BL SP LATERAL DOOR HOLDER BRACKET	1.000	PC
Code	Description	Qty	UOM																						
VI0515A0	STAINLESS STEEL WASHER D=5 6592	2.000	PC																						
VI1995A0	M5x25 ST.STEEL SCREW	2.000	PC																						
VM2458A0	BL SP LATERAL DOOR LOW BRACKET COVER	1.000	PC																						
VM2469A0	BL SP LATERAL DOOR HOLDER BRACKET	1.000	PC																						
VM1631A	PLUS INNER GLASS PUSHING CAP		KVM1631A	CAP FOR INTERNAL GLASS 10 PCS KIT	<table border="1"> <thead> <tr> <th>Code</th> <th>Description</th> <th>Qty</th> <th>UOM</th> </tr> </thead> <tbody> <tr> <td>VM1631A0</td> <td>PLUS INNER GLASS PUSHING CAP</td> <td>10.000</td> <td>PC</td> </tr> </tbody> </table>	Code	Description	Qty	UOM	VM1631A0	PLUS INNER GLASS PUSHING CAP	10.000	PC												
Code	Description	Qty	UOM																						
VM1631A0	PLUS INNER GLASS PUSHING CAP	10.000	PC																						
VM2490A	460X330 SP EXT FRONT BOTTOM GASKET		KVM2490A	SP 460X330 EXT BOTTOM PANEL GASKET KIT	<table border="1"> <thead> <tr> <th>Code</th> <th>Description</th> <th>Qty</th> <th>UOM</th> </tr> </thead> <tbody> <tr> <td>VM1794A0</td> <td>250x4.8 PA66 BLACK CLAMP</td> <td>2.000</td> <td>PC</td> </tr> <tr> <td>VM2103A0</td> <td>CLAMP LOCK</td> <td>2.000</td> <td>PC</td> </tr> <tr> <td>VM2490A0</td> <td>460X330 SP EXT FRONT BOTTOM GASKET</td> <td>2.000</td> <td>PC</td> </tr> </tbody> </table>	Code	Description	Qty	UOM	VM1794A0	250x4.8 PA66 BLACK CLAMP	2.000	PC	VM2103A0	CLAMP LOCK	2.000	PC	VM2490A0	460X330 SP EXT FRONT BOTTOM GASKET	2.000	PC				
Code	Description	Qty	UOM																						
VM1794A0	250x4.8 PA66 BLACK CLAMP	2.000	PC																						
VM2103A0	CLAMP LOCK	2.000	PC																						
VM2490A0	460X330 SP EXT FRONT BOTTOM GASKET	2.000	PC																						



COMPONENT			SPARE PART																						
Code	Description	Image	Code	Description	Kit components																				
VM2491A	460X330 BL SP LATER BOTTOM PANEL GASKET		KVM2491A	SP 460X330 LAT BOTT PANEL GASKET 2PC KIT	<table border="1"> <thead> <tr> <th>Code</th> <th>Description</th> <th>Qty</th> <th>UOM</th> </tr> </thead> <tbody> <tr> <td>VM1631A0</td> <td>PLUS INNER GLASS PUSHING CAP</td> <td>4.000</td> <td>PC</td> </tr> <tr> <td>VM1794A0</td> <td>250x4.8 PA66 BLACK CLAMP</td> <td>2.000</td> <td>PC</td> </tr> <tr> <td>VM2103A0</td> <td>CLAMP LOCK</td> <td>2.000</td> <td>PC</td> </tr> <tr> <td>VM2491A1</td> <td>460x330 BLSP LATERAL BOTTOM PANEL GASKE</td> <td>2.000</td> <td>PC</td> </tr> </tbody> </table>	Code	Description	Qty	UOM	VM1631A0	PLUS INNER GLASS PUSHING CAP	4.000	PC	VM1794A0	250x4.8 PA66 BLACK CLAMP	2.000	PC	VM2103A0	CLAMP LOCK	2.000	PC	VM2491A1	460x330 BLSP LATERAL BOTTOM PANEL GASKE	2.000	PC
Code	Description	Qty	UOM																						
VM1631A0	PLUS INNER GLASS PUSHING CAP	4.000	PC																						
VM1794A0	250x4.8 PA66 BLACK CLAMP	2.000	PC																						
VM2103A0	CLAMP LOCK	2.000	PC																						
VM2491A1	460x330 BLSP LATERAL BOTTOM PANEL GASKE	2.000	PC																						
VM1222A	CABLE LOCKS SP ACCESSORIES EL CONNECTION		VM1222A0	CABLE LOCKS SP ACCESSORIES EL CONNECTION																					
VM2249A	COOKING CHAMBER FRONT CORNER		KVM2249A	CHAMBER FRONT PROFILE CORNER KIT	<table border="1"> <thead> <tr> <th>Code</th> <th>Description</th> <th>Qty</th> <th>UOM</th> </tr> </thead> <tbody> <tr> <td>VM2249A0</td> <td>COOKING CHAMBER FRONT CORNER</td> <td>1.000</td> <td>PC</td> </tr> </tbody> </table>	Code	Description	Qty	UOM	VM2249A0	COOKING CHAMBER FRONT CORNER	1.000	PC												
Code	Description	Qty	UOM																						
VM2249A0	COOKING CHAMBER FRONT CORNER	1.000	PC																						

ASM3427A/0.D00 - Door

FRONT







ASM3427A/0.D00 - Door

REAR







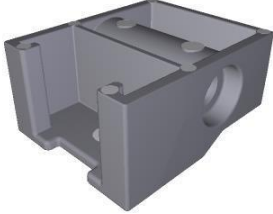
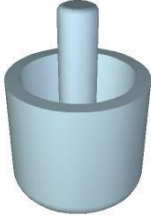
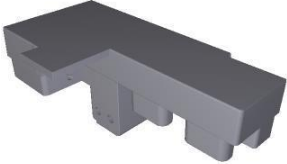

COMPONENT			SPARE PART																										
Code	Description	Image	Code	Description	Kit components																								
0B1298A	SP ARI-ROS RIGHT DOOR LEFT INT COLUMN		0B1298A0	SP ARI-ROS RIGHT DOOR LEFT INT COLUMN																									
0B1300A	SP ARI-ROS RIGHT DOOR RIGHT INT COLUMN		0B1300A0	SP ARI-ROS RIGHT DOOR RIGHT INT COLUMN																									
LP1050A	BL SHOP.PRO L180 COMPLETE LED BA		KLP1050A	L180 COMPLETE LED LIGHT BAR KIT	<table border="1"> <thead> <tr> <th>Code</th> <th>Description</th> <th>Qty</th> <th>UOM</th> </tr> </thead> <tbody> <tr> <td>LP1050A0</td> <td>BL SHOP.PRO L180 COMPLETE LED BAR</td> <td>1.000</td> <td>PC</td> </tr> <tr> <td>VI1014A0</td> <td>STAINLESS STEEL WASHER 4.5X9X0.8</td> <td>1.000</td> <td>PC</td> </tr> <tr> <td>VI1220A1</td> <td>4,2x12 TCB SELF-TAPPING SCREW</td> <td>1.000</td> <td>PC</td> </tr> </tbody> </table>	Code	Description	Qty	UOM	LP1050A0	BL SHOP.PRO L180 COMPLETE LED BAR	1.000	PC	VI1014A0	STAINLESS STEEL WASHER 4.5X9X0.8	1.000	PC	VI1220A1	4,2x12 TCB SELF-TAPPING SCREW	1.000	PC								
Code	Description	Qty	UOM																										
LP1050A0	BL SHOP.PRO L180 COMPLETE LED BAR	1.000	PC																										
VI1014A0	STAINLESS STEEL WASHER 4.5X9X0.8	1.000	PC																										
VI1220A1	4,2x12 TCB SELF-TAPPING SCREW	1.000	PC																										
TB3304A	SHOP.PRO ARI-ROS FLAG DOOR HANDLE TUBE		KTB3304A	BL SP ARI-ROS LATER DOOR HANDLE TUBE KIT	<table border="1"> <thead> <tr> <th>Code</th> <th>Description</th> <th>Qty</th> <th>UOM</th> </tr> </thead> <tbody> <tr> <td>TB3304A0</td> <td>SHOP.PRO ARI-ROS FLAG DOOR HANDLE TUBE</td> <td>1.000</td> <td>PC</td> </tr> <tr> <td>VI1147A0</td> <td>5X25 STAINLESS STEEL SCREW</td> <td>4.000</td> <td>PC</td> </tr> <tr> <td>VM2456A0</td> <td>BAKERLUX SHOP.PRO HANDLE END</td> <td>1.000</td> <td>PC</td> </tr> <tr> <td>VM2489A0</td> <td>SP HANDLE END KIT + STYLUS KIT</td> <td>1.000</td> <td>PC</td> </tr> <tr> <td>VM2527A0</td> <td>STYLUS PEN FOR SP</td> <td>1.000</td> <td>PC</td> </tr> </tbody> </table>	Code	Description	Qty	UOM	TB3304A0	SHOP.PRO ARI-ROS FLAG DOOR HANDLE TUBE	1.000	PC	VI1147A0	5X25 STAINLESS STEEL SCREW	4.000	PC	VM2456A0	BAKERLUX SHOP.PRO HANDLE END	1.000	PC	VM2489A0	SP HANDLE END KIT + STYLUS KIT	1.000	PC	VM2527A0	STYLUS PEN FOR SP	1.000	PC
Code	Description	Qty	UOM																										
TB3304A0	SHOP.PRO ARI-ROS FLAG DOOR HANDLE TUBE	1.000	PC																										
VI1147A0	5X25 STAINLESS STEEL SCREW	4.000	PC																										
VM2456A0	BAKERLUX SHOP.PRO HANDLE END	1.000	PC																										
VM2489A0	SP HANDLE END KIT + STYLUS KIT	1.000	PC																										
VM2527A0	STYLUS PEN FOR SP	1.000	PC																										

COMPONENT			SPARE PART																						
Code	Description	Image	Code	Description	Kit components																				
VM2456A	BAKERLUX SHOP.PRO HANDLE END		KVM2456A	2 PCS BAKERLUX SHOP.PRO HANDLE END KIT	<table border="1"> <thead> <tr> <th>Code</th> <th>Description</th> <th>Qty</th> <th>UOM</th> </tr> </thead> <tbody> <tr> <td>VI1147A0</td> <td>5X25 STAINLESS STEEL SCREW</td> <td>4.000</td> <td>PC</td> </tr> <tr> <td>VM2456A0</td> <td>BAKERLUX SHOP.PRO HANDLE END</td> <td>1.000</td> <td>PC</td> </tr> <tr> <td>VM2489A0</td> <td>SP HANDLE END KIT + STYLUS KIT</td> <td>1.000</td> <td>PC</td> </tr> <tr> <td>VM2527A0</td> <td>STYLUS PEN FOR SP</td> <td>1.000</td> <td>PC</td> </tr> </tbody> </table>	Code	Description	Qty	UOM	VI1147A0	5X25 STAINLESS STEEL SCREW	4.000	PC	VM2456A0	BAKERLUX SHOP.PRO HANDLE END	1.000	PC	VM2489A0	SP HANDLE END KIT + STYLUS KIT	1.000	PC	VM2527A0	STYLUS PEN FOR SP	1.000	PC
Code	Description	Qty	UOM																						
VI1147A0	5X25 STAINLESS STEEL SCREW	4.000	PC																						
VM2456A0	BAKERLUX SHOP.PRO HANDLE END	1.000	PC																						
VM2489A0	SP HANDLE END KIT + STYLUS KIT	1.000	PC																						
VM2527A0	STYLUS PEN FOR SP	1.000	PC																						
VM2527A	STYLUS PEN FOR S		KVM2527A	EVEREO-BLSP TOUCH STYLUS 5 PCS KIT	<table border="1"> <thead> <tr> <th>Code</th> <th>Description</th> <th>Qty</th> <th>UOM</th> </tr> </thead> <tbody> <tr> <td>VM2527A0</td> <td>STYLUS PEN FOR SP</td> <td>5.000</td> <td>PC</td> </tr> </tbody> </table>	Code	Description	Qty	UOM	VM2527A0	STYLUS PEN FOR SP	5.000	PC												
Code	Description	Qty	UOM																						
VM2527A0	STYLUS PEN FOR SP	5.000	PC																						
VM2468A	BL SP LEFT UPPER LATERAL DOOR CA		KVM2468A	BL SP LEFT UPPER LATERAL DOOR CAP KIT	<table border="1"> <thead> <tr> <th>Code</th> <th>Description</th> <th>Qty</th> <th>UOM</th> </tr> </thead> <tbody> <tr> <td>VM2468A0</td> <td>BL SP LEFT UPPER LATERAL DOOR CAP</td> <td>1.000</td> <td>PC</td> </tr> </tbody> </table>	Code	Description	Qty	UOM	VM2468A0	BL SP LEFT UPPER LATERAL DOOR CAP	1.000	PC												
Code	Description	Qty	UOM																						
VM2468A0	BL SP LEFT UPPER LATERAL DOOR CAP	1.000	PC																						
VM2474A	BL SP INT GLASS HINGE UPPER LOCK PIN		KVM2474A	BL SP INT GLASS HINGE UPPER LOCK PIN KIT	<table border="1"> <thead> <tr> <th>Code</th> <th>Description</th> <th>Qty</th> <th>UOM</th> </tr> </thead> <tbody> <tr> <td>VM2474A0</td> <td>BL SP INT GLASS HINGE UPPER LOCK PIN</td> <td>1.000</td> <td>PC</td> </tr> </tbody> </table>	Code	Description	Qty	UOM	VM2474A0	BL SP INT GLASS HINGE UPPER LOCK PIN	1.000	PC												
Code	Description	Qty	UOM																						
VM2474A0	BL SP INT GLASS HINGE UPPER LOCK PIN	1.000	PC																						
ML1005A	DE5 DF0.6 H18 COMPRESSION SPRING		KVM2470A	BL SHOP.PRO INTERNAL GLASS LOCK 2PCS KIT	<table border="1"> <thead> <tr> <th>Code</th> <th>Description</th> <th>Qty</th> <th>UOM</th> </tr> </thead> <tbody> <tr> <td>ML1005A0</td> <td>DE5 DF0.6 H18 COMPRESSION N SPRING</td> <td>2.000</td> <td>PC</td> </tr> <tr> <td>VM2470A0</td> <td>SLIDE TO FIX INTERNAL GLASS SHOP.PRO</td> <td>2.000</td> <td>PC</td> </tr> <tr> <td>VM2504A0</td> <td>DOWEL TO GUIDE SLIDE SPRING SHOP.PRO</td> <td>2.000</td> <td>PC</td> </tr> </tbody> </table>	Code	Description	Qty	UOM	ML1005A0	DE5 DF0.6 H18 COMPRESSION N SPRING	2.000	PC	VM2470A0	SLIDE TO FIX INTERNAL GLASS SHOP.PRO	2.000	PC	VM2504A0	DOWEL TO GUIDE SLIDE SPRING SHOP.PRO	2.000	PC				
Code	Description	Qty	UOM																						
ML1005A0	DE5 DF0.6 H18 COMPRESSION N SPRING	2.000	PC																						
VM2470A0	SLIDE TO FIX INTERNAL GLASS SHOP.PRO	2.000	PC																						
VM2504A0	DOWEL TO GUIDE SLIDE SPRING SHOP.PRO	2.000	PC																						



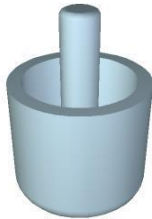

COMPONENT			SPARE PART																		
Code	Description	Image	Code	Description	Kit components																
VM2470A	SLIDE TO FIX INTERNAL GLASS SHOP.PRO		KVM2470A	BL SHOP.PRO INTERNAL GLASS LOCK 2PCS KIT	<table border="1"> <thead> <tr> <th>Code</th> <th>Description</th> <th>Qty</th> <th>UOM</th> </tr> </thead> <tbody> <tr> <td>ML1005A0</td> <td>DES DF0.6 H18 COMPRESSIO N SPRING</td> <td>2.000</td> <td>PC</td> </tr> <tr> <td>VM2470A0</td> <td>SLIDE TO FIX INTERNAL GLASS SHOP.PRO</td> <td>2.000</td> <td>PC</td> </tr> <tr> <td>VM2504A0</td> <td>DOWEL TO GUIDE SLIDE SPRING SHOP.PRO</td> <td>2.000</td> <td>PC</td> </tr> </tbody> </table>	Code	Description	Qty	UOM	ML1005A0	DES DF0.6 H18 COMPRESSIO N SPRING	2.000	PC	VM2470A0	SLIDE TO FIX INTERNAL GLASS SHOP.PRO	2.000	PC	VM2504A0	DOWEL TO GUIDE SLIDE SPRING SHOP.PRO	2.000	PC
					Code	Description	Qty	UOM													
					ML1005A0	DES DF0.6 H18 COMPRESSIO N SPRING	2.000	PC													
VM2470A0	SLIDE TO FIX INTERNAL GLASS SHOP.PRO	2.000	PC																		
VM2504A0	DOWEL TO GUIDE SLIDE SPRING SHOP.PRO	2.000	PC																		
<table border="1"> <thead> <tr> <th>Code</th> <th>Description</th> <th>Qty</th> <th>UOM</th> </tr> </thead> <tbody> <tr> <td>VH1998A0</td> <td>ZINC PLATED SCREW 5X30 TCB</td> <td>2.000</td> <td>PC</td> </tr> <tr> <td>VM2471A0</td> <td>BL SP LOWER CLAMP INT LOCK GLASS SLIDER</td> <td>1.000</td> <td>PC</td> </tr> <tr> <td>VM2472A0</td> <td>BL SP UPPER CLAMP INT LOCK GLASS SLIDER</td> <td>1.000</td> <td>PC</td> </tr> </tbody> </table>	Code	Description	Qty	UOM	VH1998A0	ZINC PLATED SCREW 5X30 TCB	2.000	PC	VM2471A0	BL SP LOWER CLAMP INT LOCK GLASS SLIDER	1.000	PC	VM2472A0	BL SP UPPER CLAMP INT LOCK GLASS SLIDER	1.000	PC					
Code	Description	Qty	UOM																		
VH1998A0	ZINC PLATED SCREW 5X30 TCB	2.000	PC																		
VM2471A0	BL SP LOWER CLAMP INT LOCK GLASS SLIDER	1.000	PC																		
VM2472A0	BL SP UPPER CLAMP INT LOCK GLASS SLIDER	1.000	PC																		
<table border="1"> <thead> <tr> <th>Code</th> <th>Description</th> <th>Qty</th> <th>UOM</th> </tr> </thead> <tbody> <tr> <td>ML1005A0</td> <td>DES DF0.6 H18 COMPRESSIO N SPRING</td> <td>2.000</td> <td>PC</td> </tr> <tr> <td>VM2470A0</td> <td>SLIDE TO FIX INTERNAL GLASS SHOP.PRO</td> <td>2.000</td> <td>PC</td> </tr> <tr> <td>VM2504A0</td> <td>DOWEL TO GUIDE SLIDE SPRING SHOP.PRO</td> <td>2.000</td> <td>PC</td> </tr> </tbody> </table>	Code	Description	Qty	UOM	ML1005A0	DES DF0.6 H18 COMPRESSIO N SPRING	2.000	PC	VM2470A0	SLIDE TO FIX INTERNAL GLASS SHOP.PRO	2.000	PC	VM2504A0	DOWEL TO GUIDE SLIDE SPRING SHOP.PRO	2.000	PC					
Code	Description	Qty	UOM																		
ML1005A0	DES DF0.6 H18 COMPRESSIO N SPRING	2.000	PC																		
VM2470A0	SLIDE TO FIX INTERNAL GLASS SHOP.PRO	2.000	PC																		
VM2504A0	DOWEL TO GUIDE SLIDE SPRING SHOP.PRO	2.000	PC																		
VM2472A	BL SP UPPER CLAMP INT LOCK GLASS SLIDER		KVM2471A	BL SP INTERNAL GLASS LOCK HOLDER KIT	<table border="1"> <thead> <tr> <th>Code</th> <th>Description</th> <th>Qty</th> <th>UOM</th> </tr> </thead> <tbody> <tr> <td>VH1998A0</td> <td>ZINC PLATED SCREW 5X30 TCB</td> <td>2.000</td> <td>PC</td> </tr> <tr> <td>VM2471A0</td> <td>BL SP LOWER CLAMP INT LOCK GLASS SLIDER</td> <td>1.000</td> <td>PC</td> </tr> <tr> <td>VM2472A0</td> <td>BL SP UPPER CLAMP INT LOCK GLASS SLIDER</td> <td>1.000</td> <td>PC</td> </tr> </tbody> </table>	Code	Description	Qty	UOM	VH1998A0	ZINC PLATED SCREW 5X30 TCB	2.000	PC	VM2471A0	BL SP LOWER CLAMP INT LOCK GLASS SLIDER	1.000	PC	VM2472A0	BL SP UPPER CLAMP INT LOCK GLASS SLIDER	1.000	PC
Code	Description	Qty	UOM																		
VH1998A0	ZINC PLATED SCREW 5X30 TCB	2.000	PC																		
VM2471A0	BL SP LOWER CLAMP INT LOCK GLASS SLIDER	1.000	PC																		
VM2472A0	BL SP UPPER CLAMP INT LOCK GLASS SLIDER	1.000	PC																		
VM2504A	DOWEL TO GUIDE SLIDE SPRING SHOP.PRO		KVM2470A	BL SHOP.PRO INTERNAL GLASS LOCK 2PCS KIT	<table border="1"> <thead> <tr> <th>Code</th> <th>Description</th> <th>Qty</th> <th>UOM</th> </tr> </thead> <tbody> <tr> <td>ML1005A0</td> <td>DES DF0.6 H18 COMPRESSIO N SPRING</td> <td>2.000</td> <td>PC</td> </tr> <tr> <td>VM2470A0</td> <td>SLIDE TO FIX INTERNAL GLASS SHOP.PRO</td> <td>2.000</td> <td>PC</td> </tr> <tr> <td>VM2504A0</td> <td>DOWEL TO GUIDE SLIDE SPRING SHOP.PRO</td> <td>2.000</td> <td>PC</td> </tr> </tbody> </table>	Code	Description	Qty	UOM	ML1005A0	DES DF0.6 H18 COMPRESSIO N SPRING	2.000	PC	VM2470A0	SLIDE TO FIX INTERNAL GLASS SHOP.PRO	2.000	PC	VM2504A0	DOWEL TO GUIDE SLIDE SPRING SHOP.PRO	2.000	PC
Code	Description	Qty	UOM																		
ML1005A0	DES DF0.6 H18 COMPRESSIO N SPRING	2.000	PC																		
VM2470A0	SLIDE TO FIX INTERNAL GLASS SHOP.PRO	2.000	PC																		
VM2504A0	DOWEL TO GUIDE SLIDE SPRING SHOP.PRO	2.000	PC																		
VM2467A	SP SIDE-OPENING DOOR RIGHT UPPER CAP KIT		KVM2467A	BL SP RIGHT UPPER LATERAL DOOR CAP KIT	<table border="1"> <thead> <tr> <th>Code</th> <th>Description</th> <th>Qty</th> <th>UOM</th> </tr> </thead> <tbody> <tr> <td>VM2467A0</td> <td>SP SIDE-OPENIN G DOOR RIGHT UPPER CAP KIT</td> <td>1.000</td> <td>PC</td> </tr> </tbody> </table>	Code	Description	Qty	UOM	VM2467A0	SP SIDE-OPENIN G DOOR RIGHT UPPER CAP KIT	1.000	PC								
Code	Description	Qty	UOM																		
VM2467A0	SP SIDE-OPENIN G DOOR RIGHT UPPER CAP KIT	1.000	PC																		

COMPONENT			SPARE PART																		
Code	Description	Image	Code	Description	Kit components																
TB1562A	DOOR LATERAL BEAM SP600		TB1562A0	DOOR LATERAL BEAM SP600																	
VM2466A	BL SP LEFT LOWER LATERAL DOOR CA		KVM2466A	BL SP LEFT LOWER LATERAL DOOR CAP KIT	<table border="1"> <thead> <tr> <th>Code</th> <th>Description</th> <th>Qty</th> <th>UOM</th> </tr> </thead> <tbody> <tr> <td>VM2466A0</td> <td>BL SP LEFT LOWER LATERAL DOOR CAP</td> <td>1.000</td> <td>PC</td> </tr> </tbody> </table>	Code	Description	Qty	UOM	VM2466A0	BL SP LEFT LOWER LATERAL DOOR CAP	1.000	PC								
Code	Description	Qty	UOM																		
VM2466A0	BL SP LEFT LOWER LATERAL DOOR CAP	1.000	PC																		
VM2473A	BL SP INT GLASS HINGE LOWER LOCK PIN		KVM2473A	BL SP INT GLASS HINGE LOWER LOCK PIN KIT	<table border="1"> <thead> <tr> <th>Code</th> <th>Description</th> <th>Qty</th> <th>UOM</th> </tr> </thead> <tbody> <tr> <td>VM2473A0</td> <td>BL SP INT GLASS HINGE LOWER LOCK PIN</td> <td>1.000</td> <td>PC</td> </tr> </tbody> </table>	Code	Description	Qty	UOM	VM2473A0	BL SP INT GLASS HINGE LOWER LOCK PIN	1.000	PC								
Code	Description	Qty	UOM																		
VM2473A0	BL SP INT GLASS HINGE LOWER LOCK PIN	1.000	PC																		
ML1005A	DE5 DF0.6 H18 COMPRESSION SPRING		KVM2470A	BL SHOP.PRO INTERNAL GLASS LOCK 2PCS KIT	<table border="1"> <thead> <tr> <th>Code</th> <th>Description</th> <th>Qty</th> <th>UOM</th> </tr> </thead> <tbody> <tr> <td>ML1005A0</td> <td>DE5 DF0.6 H18 COMPRESSION SPRING</td> <td>2.000</td> <td>PC</td> </tr> <tr> <td>VM2470A0</td> <td>SLIDE TO FIX INTERNAL GLASS SHOP.PRO</td> <td>2.000</td> <td>PC</td> </tr> <tr> <td>VM2504A0</td> <td>DOWEL TO GUIDE SLIDE SPRING SHOP.PRO</td> <td>2.000</td> <td>PC</td> </tr> </tbody> </table>	Code	Description	Qty	UOM	ML1005A0	DE5 DF0.6 H18 COMPRESSION SPRING	2.000	PC	VM2470A0	SLIDE TO FIX INTERNAL GLASS SHOP.PRO	2.000	PC	VM2504A0	DOWEL TO GUIDE SLIDE SPRING SHOP.PRO	2.000	PC
Code	Description	Qty	UOM																		
ML1005A0	DE5 DF0.6 H18 COMPRESSION SPRING	2.000	PC																		
VM2470A0	SLIDE TO FIX INTERNAL GLASS SHOP.PRO	2.000	PC																		
VM2504A0	DOWEL TO GUIDE SLIDE SPRING SHOP.PRO	2.000	PC																		
VM2470A	SLIDE TO FIX INTERNAL GLASS SHOP.PRO		KVM2470A	BL SHOP.PRO INTERNAL GLASS LOCK 2PCS KIT	<table border="1"> <thead> <tr> <th>Code</th> <th>Description</th> <th>Qty</th> <th>UOM</th> </tr> </thead> <tbody> <tr> <td>ML1005A0</td> <td>DE5 DF0.6 H18 COMPRESSION SPRING</td> <td>2.000</td> <td>PC</td> </tr> <tr> <td>VM2470A0</td> <td>SLIDE TO FIX INTERNAL GLASS SHOP.PRO</td> <td>2.000</td> <td>PC</td> </tr> <tr> <td>VM2504A0</td> <td>DOWEL TO GUIDE SLIDE SPRING SHOP.PRO</td> <td>2.000</td> <td>PC</td> </tr> </tbody> </table>	Code	Description	Qty	UOM	ML1005A0	DE5 DF0.6 H18 COMPRESSION SPRING	2.000	PC	VM2470A0	SLIDE TO FIX INTERNAL GLASS SHOP.PRO	2.000	PC	VM2504A0	DOWEL TO GUIDE SLIDE SPRING SHOP.PRO	2.000	PC
Code	Description	Qty	UOM																		
ML1005A0	DE5 DF0.6 H18 COMPRESSION SPRING	2.000	PC																		
VM2470A0	SLIDE TO FIX INTERNAL GLASS SHOP.PRO	2.000	PC																		
VM2504A0	DOWEL TO GUIDE SLIDE SPRING SHOP.PRO	2.000	PC																		

COMPONENT			SPARE PART																		
Code	Description	Image	Code	Description	Kit components																
VM2471A	BL SP LOWER CLAMP INT LOCK GLASS SLIDER		KVM2471A	BL SP INTERNAL GLASS LOCK HOLDER KIT	<table border="1"> <thead> <tr> <th>Code</th> <th>Description</th> <th>Qty</th> <th>UOM</th> </tr> </thead> <tbody> <tr> <td>VI1998A0</td> <td>ZINC PLATED SCREW 5X30 TCB</td> <td>2.000</td> <td>PC</td> </tr> <tr> <td>VM2471A0</td> <td>BL SP LOWER CLAMP INT LOCK GLASS SLIDER</td> <td>1.000</td> <td>PC</td> </tr> <tr> <td>VM2472A0</td> <td>BL SP UPPER CLAMP INT LOCK GLASS SLIDER</td> <td>1.000</td> <td>PC</td> </tr> </tbody> </table>	Code	Description	Qty	UOM	VI1998A0	ZINC PLATED SCREW 5X30 TCB	2.000	PC	VM2471A0	BL SP LOWER CLAMP INT LOCK GLASS SLIDER	1.000	PC	VM2472A0	BL SP UPPER CLAMP INT LOCK GLASS SLIDER	1.000	PC
Code	Description	Qty	UOM																		
VI1998A0	ZINC PLATED SCREW 5X30 TCB	2.000	PC																		
VM2471A0	BL SP LOWER CLAMP INT LOCK GLASS SLIDER	1.000	PC																		
VM2472A0	BL SP UPPER CLAMP INT LOCK GLASS SLIDER	1.000	PC																		
VM2504A	DOWEL TO GUIDE SLIDE SPRING SHOP.PRO		KVM2470A	BL SHOP.PRO INTERNAL GLASS LOCK 2PCS KIT	<table border="1"> <thead> <tr> <th>Code</th> <th>Description</th> <th>Qty</th> <th>UOM</th> </tr> </thead> <tbody> <tr> <td>ML1005A0</td> <td>DES DF0.6 H18 COMPRESSION N SPRING</td> <td>2.000</td> <td>PC</td> </tr> <tr> <td>VM2470A0</td> <td>SLIDE TO FIX INTERNAL GLASS SHOP.PRO</td> <td>2.000</td> <td>PC</td> </tr> <tr> <td>VM2504A0</td> <td>DOWEL TO GUIDE SLIDE SPRING SHOP.PRO</td> <td>2.000</td> <td>PC</td> </tr> </tbody> </table>	Code	Description	Qty	UOM	ML1005A0	DES DF0.6 H18 COMPRESSION N SPRING	2.000	PC	VM2470A0	SLIDE TO FIX INTERNAL GLASS SHOP.PRO	2.000	PC	VM2504A0	DOWEL TO GUIDE SLIDE SPRING SHOP.PRO	2.000	PC
Code	Description	Qty	UOM																		
ML1005A0	DES DF0.6 H18 COMPRESSION N SPRING	2.000	PC																		
VM2470A0	SLIDE TO FIX INTERNAL GLASS SHOP.PRO	2.000	PC																		
VM2504A0	DOWEL TO GUIDE SLIDE SPRING SHOP.PRO	2.000	PC																		
VM2465A	SP SIDE-OPENING DOOR RIGHT LOWER CAP KIT		KVM2465A	BL SP RIGHT LOWER LATERAL DOOR CAP KIT	<table border="1"> <thead> <tr> <th>Code</th> <th>Description</th> <th>Qty</th> <th>UOM</th> </tr> </thead> <tbody> <tr> <td>VM2465A0</td> <td>SP SIDE-OPENIN G DOOR RIGHT LOWER CAP KIT</td> <td>1.000</td> <td>PC</td> </tr> </tbody> </table>	Code	Description	Qty	UOM	VM2465A0	SP SIDE-OPENIN G DOOR RIGHT LOWER CAP KIT	1.000	PC								
Code	Description	Qty	UOM																		
VM2465A0	SP SIDE-OPENIN G DOOR RIGHT LOWER CAP KIT	1.000	PC																		
TB1562A	DOOR LATERAL BEAM SP600		TB1562A0	DOOR LATERAL BEAM SP600																	

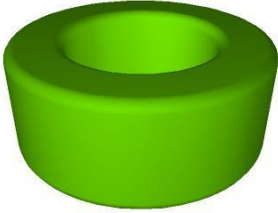
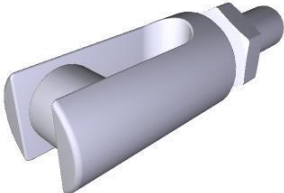

COMPONENT			SPARE PART														
Code	Description	Image	Code	Description	Kit components												
VM1630A	INTERNAL GLASS PUSHING CAP		KVM1630A	CAP FOR INTERNAL GLASS 10 PCS KIT	<table border="1"> <thead> <tr> <th>Code</th> <th>Description</th> <th>Qty</th> <th>UOM</th> </tr> </thead> <tbody> <tr> <td>VM1630A1</td> <td>INTERNAL GLASS PUSHING CAP</td> <td>10.000</td> <td>PC</td> </tr> </tbody> </table>	Code	Description	Qty	UOM	VM1630A1	INTERNAL GLASS PUSHING CAP	10.000	PC				
Code	Description	Qty	UOM														
VM1630A1	INTERNAL GLASS PUSHING CAP	10.000	PC														
VM2478A	BL SP GLASS H4 PUSHING BRACKET		KVM2478A	BL SHOP.PRO H4 GLASS SUPPORT 4 PCS KIT	<table border="1"> <thead> <tr> <th>Code</th> <th>Description</th> <th>Qty</th> <th>UOM</th> </tr> </thead> <tbody> <tr> <td>VM1630A1</td> <td>INTERNAL GLASS PUSHING CAP</td> <td>4.000</td> <td>PC</td> </tr> <tr> <td>VM2478A0</td> <td>BL SP GLASS H4 PUSHING BRACKET</td> <td>4.000</td> <td>PC</td> </tr> </tbody> </table>	Code	Description	Qty	UOM	VM1630A1	INTERNAL GLASS PUSHING CAP	4.000	PC	VM2478A0	BL SP GLASS H4 PUSHING BRACKET	4.000	PC
Code	Description	Qty	UOM														
VM1630A1	INTERNAL GLASS PUSHING CAP	4.000	PC														
VM2478A0	BL SP GLASS H4 PUSHING BRACKET	4.000	PC														
CE1095A	4 POLES MICROFIT 2 M BUS CABLE		KCE1095A	4POLES 2M BUS CABLE KIT POWER-CONTROL	<table border="1"> <thead> <tr> <th>Code</th> <th>Description</th> <th>Qty</th> <th>UOM</th> </tr> </thead> <tbody> <tr> <td>CE1095A0</td> <td>4 POLES MICROFIT 2 M BUS CABLE</td> <td>1.000</td> <td>PC</td> </tr> </tbody> </table>	Code	Description	Qty	UOM	CE1095A0	4 POLES MICROFIT 2 M BUS CABLE	1.000	PC				
Code	Description	Qty	UOM														
CE1095A0	4 POLES MICROFIT 2 M BUS CABLE	1.000	PC														
CE1285A	EMI ROUND FERRITE MOD.2643801502		KCE1285A	ROUND FERRITE ELECTROMAGN PROT. 2PCS KIT	<table border="1"> <thead> <tr> <th>Code</th> <th>Description</th> <th>Qty</th> <th>UOM</th> </tr> </thead> <tbody> <tr> <td>CE1285A0</td> <td>EMI ROUND FERRITE MOD.2643801502</td> <td>2.000</td> <td>PC</td> </tr> </tbody> </table>	Code	Description	Qty	UOM	CE1285A0	EMI ROUND FERRITE MOD.2643801502	2.000	PC				
Code	Description	Qty	UOM														
CE1285A0	EMI ROUND FERRITE MOD.2643801502	2.000	PC														
CR1040A	DOOR LATCH FOR EL.MECH. LOCKING SYSTEM		KCR1040A	LM MATIC DOOR LOCKING PIN KIT	<table border="1"> <thead> <tr> <th>Code</th> <th>Description</th> <th>Qty</th> <th>UOM</th> </tr> </thead> <tbody> <tr> <td>CR1040A0</td> <td>DOOR LATCH FOR EL.MECH. LOCKING SYSTEM</td> <td>1.000</td> <td>PC</td> </tr> </tbody> </table>	Code	Description	Qty	UOM	CR1040A0	DOOR LATCH FOR EL.MECH. LOCKING SYSTEM	1.000	PC				
Code	Description	Qty	UOM														
CR1040A0	DOOR LATCH FOR EL.MECH. LOCKING SYSTEM	1.000	PC														



COMPONENT			SPARE PART																																																										
Code	Description	Image	Code	Description	Kit components																																																								
PE2109A	SP TOUCH COMPLETE CONTROL BOARD		KPE2109A	BL SHOP.PRO TOUCH CONTROL BOARD KIT	<table border="1"> <thead> <tr> <th>Code</th> <th>Description</th> <th>Qty</th> <th>UOM</th> </tr> </thead> <tbody> <tr> <td>PE2109A3</td> <td>SP TOUCH COMPLETE CONTROL BOARD</td> <td>1.000</td> <td>PC</td> </tr> <tr> <td>V11147A0</td> <td>5X25 STAINLESS STEEL SCREW</td> <td>2.000</td> <td>PC</td> </tr> </tbody> </table>	Code	Description	Qty	UOM	PE2109A3	SP TOUCH COMPLETE CONTROL BOARD	1.000	PC	V11147A0	5X25 STAINLESS STEEL SCREW	2.000	PC																																												
Code	Description	Qty	UOM																																																										
PE2109A3	SP TOUCH COMPLETE CONTROL BOARD	1.000	PC																																																										
V11147A0	5X25 STAINLESS STEEL SCREW	2.000	PC																																																										
VM1209A	SHOP.PRO LOCK PIN WASHER		KVM1209A	BAKERLUX SHOP.PRO PIN BUSHING LOCK KIT	<table border="1"> <thead> <tr> <th>Code</th> <th>Description</th> <th>Qty</th> <th>UOM</th> </tr> </thead> <tbody> <tr> <td>VM1209A0</td> <td>SHOP.PRO LOCK PIN WASHER</td> <td>1.000</td> <td>PC</td> </tr> </tbody> </table>	Code	Description	Qty	UOM	VM1209A0	SHOP.PRO LOCK PIN WASHER	1.000	PC																																																
Code	Description	Qty	UOM																																																										
VM1209A0	SHOP.PRO LOCK PIN WASHER	1.000	PC																																																										
VM2274A	GROOVED BUSHING		KVM2274A K0B1126AR	GROOVED PIN BUSHING KIT BAKERTOP MM RIGHT DOOR LOWER BEAM KIT	<table border="1"> <thead> <tr> <th>Code</th> <th>Description</th> <th>Qty</th> <th>UOM</th> </tr> </thead> <tbody> <tr> <td>VM2274A0</td> <td>GROOVED BUSHING</td> <td>1.000</td> <td>PC</td> </tr> <tr> <td>OB1126A1</td> <td>MM BT DOOR LOWER CROSS BAR</td> <td>1.000</td> <td>PC</td> </tr> <tr> <td>RC1200A0</td> <td>ED=4 WIRE D.=0.5 COMPRESSIO N SPRING</td> <td>2.000</td> <td>PC</td> </tr> <tr> <td>V11220A1</td> <td>4,2x12 TCB SELF-TAPPIN G SCREW</td> <td>1.000</td> <td>PC</td> </tr> <tr> <td>V11996A0</td> <td>M5x35 SCREW</td> <td>7.000</td> <td>PC</td> </tr> <tr> <td>VM1794A0</td> <td>250x4.8 PA66 BLACK CLAMP</td> <td>2.000</td> <td>PC</td> </tr> <tr> <td>VM2103A0</td> <td>CLAMP LOCK</td> <td>2.000</td> <td>PC</td> </tr> <tr> <td>VM2259A1</td> <td>6 SERIES DOOR LOWER LEFT CAP</td> <td>1.000</td> <td>PC</td> </tr> <tr> <td>VM2261A1</td> <td>MM DOOR LOWER RIGHT CAP</td> <td>1.000</td> <td>PC</td> </tr> <tr> <td>VM2267A0</td> <td>INTERNAL GLASS LOCKING SYSTEM SLIDER</td> <td>1.000</td> <td>PC</td> </tr> <tr> <td>VM2269A0</td> <td>INTERNAL GLASS LOCKING SYSTEM CAP</td> <td>1.000</td> <td>PC</td> </tr> <tr> <td>VM2274A0</td> <td>GROOVED BUSHING</td> <td>1.000</td> <td>PC</td> </tr> <tr> <td>VM2305A0</td> <td>MM SERIES DOOR CAP FIXING PAWL</td> <td>7.000</td> <td>PC</td> </tr> </tbody> </table>	Code	Description	Qty	UOM	VM2274A0	GROOVED BUSHING	1.000	PC	OB1126A1	MM BT DOOR LOWER CROSS BAR	1.000	PC	RC1200A0	ED=4 WIRE D.=0.5 COMPRESSIO N SPRING	2.000	PC	V11220A1	4,2x12 TCB SELF-TAPPIN G SCREW	1.000	PC	V11996A0	M5x35 SCREW	7.000	PC	VM1794A0	250x4.8 PA66 BLACK CLAMP	2.000	PC	VM2103A0	CLAMP LOCK	2.000	PC	VM2259A1	6 SERIES DOOR LOWER LEFT CAP	1.000	PC	VM2261A1	MM DOOR LOWER RIGHT CAP	1.000	PC	VM2267A0	INTERNAL GLASS LOCKING SYSTEM SLIDER	1.000	PC	VM2269A0	INTERNAL GLASS LOCKING SYSTEM CAP	1.000	PC	VM2274A0	GROOVED BUSHING	1.000	PC	VM2305A0	MM SERIES DOOR CAP FIXING PAWL	7.000	PC
Code	Description	Qty	UOM																																																										
VM2274A0	GROOVED BUSHING	1.000	PC																																																										
OB1126A1	MM BT DOOR LOWER CROSS BAR	1.000	PC																																																										
RC1200A0	ED=4 WIRE D.=0.5 COMPRESSIO N SPRING	2.000	PC																																																										
V11220A1	4,2x12 TCB SELF-TAPPIN G SCREW	1.000	PC																																																										
V11996A0	M5x35 SCREW	7.000	PC																																																										
VM1794A0	250x4.8 PA66 BLACK CLAMP	2.000	PC																																																										
VM2103A0	CLAMP LOCK	2.000	PC																																																										
VM2259A1	6 SERIES DOOR LOWER LEFT CAP	1.000	PC																																																										
VM2261A1	MM DOOR LOWER RIGHT CAP	1.000	PC																																																										
VM2267A0	INTERNAL GLASS LOCKING SYSTEM SLIDER	1.000	PC																																																										
VM2269A0	INTERNAL GLASS LOCKING SYSTEM CAP	1.000	PC																																																										
VM2274A0	GROOVED BUSHING	1.000	PC																																																										
VM2305A0	MM SERIES DOOR CAP FIXING PAWL	7.000	PC																																																										



COMPONENT			SPARE PART																																																																																									
Code	Description	Image	Code	Description	Kit components																																																																																							
VM2274A	GROOVED BUSHING		K0B1126AL	EU AND 2/1 MM LEFT DOOR LOWER BEAM KIT	<table border="1"> <thead> <tr> <th>Code</th> <th>Description</th> <th>Qty</th> <th>UOM</th> </tr> </thead> <tbody> <tr> <td>0B1126A1</td> <td>MM BT DOOR LOWER CROSS BAR</td> <td>1.000</td> <td>PC</td> </tr> <tr> <td>RC1200A0</td> <td>ED=4 WIRE D.=0.5 COMPRESSIO N SPRING</td> <td>2.000</td> <td>PC</td> </tr> <tr> <td>V11220A1</td> <td>4,2x12 TCB SELF-TAPPIN G SCREW</td> <td>1.000</td> <td>PC</td> </tr> <tr> <td>V11996A0</td> <td>M5x35 SCREW</td> <td>7.000</td> <td>PC</td> </tr> <tr> <td>VM1794A0</td> <td>250x4.8 PA66 BLACK CLAMP</td> <td>2.000</td> <td>PC</td> </tr> <tr> <td>VM2103A0</td> <td>CLAMP LOCK</td> <td>2.000</td> <td>PC</td> </tr> <tr> <td>VM2267A0</td> <td>INTERNAL GLASS LOCKING SYSTEM SLIDER</td> <td>1.000</td> <td>PC</td> </tr> <tr> <td>VM2269A0</td> <td>INTERNAL GLASS LOCKING SYSTEM CAP</td> <td>1.000</td> <td>PC</td> </tr> <tr> <td>VM2274A0</td> <td>GROOVED BUSHING</td> <td>1.000</td> <td>PC</td> </tr> <tr> <td>VM2305A0</td> <td>MM SERIES DOOR CAP FIXING PAWL</td> <td>7.000</td> <td>PC</td> </tr> <tr> <td>VM2384A0</td> <td>MM LEFT DOOR RIGHT LOWER CAP</td> <td>1.000</td> <td>PC</td> </tr> <tr> <td>VM2386A1</td> <td>LEFT MM DOOR LOWER LEFT CAP</td> <td>1.000</td> <td>PC</td> </tr> </tbody> </table>	Code	Description	Qty	UOM	0B1126A1	MM BT DOOR LOWER CROSS BAR	1.000	PC	RC1200A0	ED=4 WIRE D.=0.5 COMPRESSIO N SPRING	2.000	PC	V11220A1	4,2x12 TCB SELF-TAPPIN G SCREW	1.000	PC	V11996A0	M5x35 SCREW	7.000	PC	VM1794A0	250x4.8 PA66 BLACK CLAMP	2.000	PC	VM2103A0	CLAMP LOCK	2.000	PC	VM2267A0	INTERNAL GLASS LOCKING SYSTEM SLIDER	1.000	PC	VM2269A0	INTERNAL GLASS LOCKING SYSTEM CAP	1.000	PC	VM2274A0	GROOVED BUSHING	1.000	PC	VM2305A0	MM SERIES DOOR CAP FIXING PAWL	7.000	PC	VM2384A0	MM LEFT DOOR RIGHT LOWER CAP	1.000	PC	VM2386A1	LEFT MM DOOR LOWER LEFT CAP	1.000	PC	K0B1122AR	CHEFTOP MM RIGHT DOOR LOWER BEAM KIT	<table border="1"> <thead> <tr> <th>Code</th> <th>Description</th> <th>Qty</th> <th>UOM</th> </tr> </thead> <tbody> <tr> <td>0B1122A1</td> <td>750MM DOOR LOWER FRAME SHAPE</td> <td>1.000</td> <td>PC</td> </tr> <tr> <td>RC1200A0</td> <td>ED=4 WIRE D.=0.5 COMPRESSIO N SPRING</td> <td>2.000</td> <td>PC</td> </tr> <tr> <td>V11220A1</td> <td>4,2x12 TCB SELF-TAPPIN G SCREW</td> <td>1.000</td> <td>PC</td> </tr> <tr> <td>V11996A0</td> <td>M5x35 SCREW</td> <td>7.000</td> <td>PC</td> </tr> <tr> <td>VM1794A0</td> <td>250x4.8 PA66 BLACK CLAMP</td> <td>2.000</td> <td>PC</td> </tr> <tr> <td>VM2103A0</td> <td>CLAMP LOCK</td> <td>2.000</td> <td>PC</td> </tr> <tr> <td>VM2259A1</td> <td>6 SERIES DOOR LOWER LEFT CAP</td> <td>1.000</td> <td>PC</td> </tr> </tbody> </table>	Code	Description	Qty	UOM	0B1122A1	750MM DOOR LOWER FRAME SHAPE	1.000	PC	RC1200A0	ED=4 WIRE D.=0.5 COMPRESSIO N SPRING	2.000	PC	V11220A1	4,2x12 TCB SELF-TAPPIN G SCREW	1.000	PC	V11996A0	M5x35 SCREW	7.000	PC	VM1794A0	250x4.8 PA66 BLACK CLAMP	2.000	PC	VM2103A0	CLAMP LOCK	2.000	PC	VM2259A1	6 SERIES DOOR LOWER LEFT CAP	1.000	PC
			Code	Description	Qty	UOM																																																																																						
0B1126A1	MM BT DOOR LOWER CROSS BAR	1.000	PC																																																																																									
RC1200A0	ED=4 WIRE D.=0.5 COMPRESSIO N SPRING	2.000	PC																																																																																									
V11220A1	4,2x12 TCB SELF-TAPPIN G SCREW	1.000	PC																																																																																									
V11996A0	M5x35 SCREW	7.000	PC																																																																																									
VM1794A0	250x4.8 PA66 BLACK CLAMP	2.000	PC																																																																																									
VM2103A0	CLAMP LOCK	2.000	PC																																																																																									
VM2267A0	INTERNAL GLASS LOCKING SYSTEM SLIDER	1.000	PC																																																																																									
VM2269A0	INTERNAL GLASS LOCKING SYSTEM CAP	1.000	PC																																																																																									
VM2274A0	GROOVED BUSHING	1.000	PC																																																																																									
VM2305A0	MM SERIES DOOR CAP FIXING PAWL	7.000	PC																																																																																									
VM2384A0	MM LEFT DOOR RIGHT LOWER CAP	1.000	PC																																																																																									
VM2386A1	LEFT MM DOOR LOWER LEFT CAP	1.000	PC																																																																																									
Code	Description	Qty	UOM																																																																																									
0B1122A1	750MM DOOR LOWER FRAME SHAPE	1.000	PC																																																																																									
RC1200A0	ED=4 WIRE D.=0.5 COMPRESSIO N SPRING	2.000	PC																																																																																									
V11220A1	4,2x12 TCB SELF-TAPPIN G SCREW	1.000	PC																																																																																									
V11996A0	M5x35 SCREW	7.000	PC																																																																																									
VM1794A0	250x4.8 PA66 BLACK CLAMP	2.000	PC																																																																																									
VM2103A0	CLAMP LOCK	2.000	PC																																																																																									
VM2259A1	6 SERIES DOOR LOWER LEFT CAP	1.000	PC																																																																																									



COMPONENT			SPARE PART																																																			
Code	Description	Image	Code	Description	Kit components																																																	
VM2274A	GROOVED BUSHING		K0B1122AR	CHEFTOP MM RIGHT DOOR LOWER BEAM KIT	<table border="1"> <thead> <tr> <th>Code</th> <th>Description</th> <th>Qty</th> <th>UOM</th> </tr> </thead> <tbody> <tr> <td>VM2261A1</td> <td>MM DOOR LOWER RIGHT CAP</td> <td>1.000</td> <td>PC</td> </tr> <tr> <td>VM2267A0</td> <td>INTERNAL GLASS LOCKING SYSTEM SLIDER</td> <td>1.000</td> <td>PC</td> </tr> <tr> <td>VM2269A0</td> <td>INTERNAL GLASS LOCKING SYSTEM CAP</td> <td>1.000</td> <td>PC</td> </tr> <tr> <td>VM2274A0</td> <td>GROOVED BUSHING</td> <td>1.000</td> <td>PC</td> </tr> <tr> <td>VM2305A0</td> <td>MM SERIES DOOR CAP FIXING PAWL</td> <td>7.000</td> <td>PC</td> </tr> </tbody> </table>	Code	Description	Qty	UOM	VM2261A1	MM DOOR LOWER RIGHT CAP	1.000	PC	VM2267A0	INTERNAL GLASS LOCKING SYSTEM SLIDER	1.000	PC	VM2269A0	INTERNAL GLASS LOCKING SYSTEM CAP	1.000	PC	VM2274A0	GROOVED BUSHING	1.000	PC	VM2305A0	MM SERIES DOOR CAP FIXING PAWL	7.000	PC																									
			Code	Description	Qty	UOM																																																
VM2261A1	MM DOOR LOWER RIGHT CAP	1.000	PC																																																			
VM2267A0	INTERNAL GLASS LOCKING SYSTEM SLIDER	1.000	PC																																																			
VM2269A0	INTERNAL GLASS LOCKING SYSTEM CAP	1.000	PC																																																			
VM2274A0	GROOVED BUSHING	1.000	PC																																																			
VM2305A0	MM SERIES DOOR CAP FIXING PAWL	7.000	PC																																																			
K0B1122AL	CHEFTOP MM LEFT DOOR LOWER BEAM KIT	<table border="1"> <thead> <tr> <th>Code</th> <th>Description</th> <th>Qty</th> <th>UOM</th> </tr> </thead> <tbody> <tr> <td>0B1122A1</td> <td>750MM DOOR LOWER FRAME SHAPE</td> <td>1.000</td> <td>PC</td> </tr> <tr> <td>RC1200A0</td> <td>ED=4 WIRE D.=0.5 COMPRESSION N SPRING</td> <td>2.000</td> <td>PC</td> </tr> <tr> <td>V11220A1</td> <td>4,2x12 TCB SELF-TAPPIN G SCREW</td> <td>1.000</td> <td>PC</td> </tr> <tr> <td>V11996A0</td> <td>M5x35 SCREW</td> <td>7.000</td> <td>PC</td> </tr> <tr> <td>VM1794A0</td> <td>250x4.8 PA66 BLACK CLAMP</td> <td>2.000</td> <td>PC</td> </tr> <tr> <td>VM2103A0</td> <td>CLAMP LOCK</td> <td>2.000</td> <td>PC</td> </tr> <tr> <td>VM2267A0</td> <td>INTERNAL GLASS LOCKING SYSTEM SLIDER</td> <td>1.000</td> <td>PC</td> </tr> <tr> <td>VM2269A0</td> <td>INTERNAL GLASS LOCKING SYSTEM CAP</td> <td>1.000</td> <td>PC</td> </tr> <tr> <td>VM2274A0</td> <td>GROOVED BUSHING</td> <td>1.000</td> <td>PC</td> </tr> <tr> <td>VM2305A0</td> <td>MM SERIES DOOR CAP FIXING PAWL</td> <td>7.000</td> <td>PC</td> </tr> <tr> <td>VM2384A0</td> <td>MM LEFT DOOR RIGHT LOWER CAP</td> <td>1.000</td> <td>PC</td> </tr> <tr> <td>VM2386A1</td> <td>LEFT MM DOOR LOWER LEFT CAP</td> <td>1.000</td> <td>PC</td> </tr> </tbody> </table>	Code	Description	Qty	UOM	0B1122A1	750MM DOOR LOWER FRAME SHAPE	1.000	PC	RC1200A0	ED=4 WIRE D.=0.5 COMPRESSION N SPRING	2.000	PC	V11220A1	4,2x12 TCB SELF-TAPPIN G SCREW	1.000	PC	V11996A0	M5x35 SCREW	7.000	PC	VM1794A0	250x4.8 PA66 BLACK CLAMP	2.000	PC	VM2103A0	CLAMP LOCK	2.000	PC	VM2267A0	INTERNAL GLASS LOCKING SYSTEM SLIDER	1.000	PC	VM2269A0	INTERNAL GLASS LOCKING SYSTEM CAP	1.000	PC	VM2274A0	GROOVED BUSHING	1.000	PC	VM2305A0	MM SERIES DOOR CAP FIXING PAWL	7.000	PC	VM2384A0	MM LEFT DOOR RIGHT LOWER CAP	1.000	PC	VM2386A1	LEFT MM DOOR LOWER LEFT CAP	1.000	PC
Code	Description	Qty	UOM																																																			
0B1122A1	750MM DOOR LOWER FRAME SHAPE	1.000	PC																																																			
RC1200A0	ED=4 WIRE D.=0.5 COMPRESSION N SPRING	2.000	PC																																																			
V11220A1	4,2x12 TCB SELF-TAPPIN G SCREW	1.000	PC																																																			
V11996A0	M5x35 SCREW	7.000	PC																																																			
VM1794A0	250x4.8 PA66 BLACK CLAMP	2.000	PC																																																			
VM2103A0	CLAMP LOCK	2.000	PC																																																			
VM2267A0	INTERNAL GLASS LOCKING SYSTEM SLIDER	1.000	PC																																																			
VM2269A0	INTERNAL GLASS LOCKING SYSTEM CAP	1.000	PC																																																			
VM2274A0	GROOVED BUSHING	1.000	PC																																																			
VM2305A0	MM SERIES DOOR CAP FIXING PAWL	7.000	PC																																																			
VM2384A0	MM LEFT DOOR RIGHT LOWER CAP	1.000	PC																																																			
VM2386A1	LEFT MM DOOR LOWER LEFT CAP	1.000	PC																																																			

COMPONENT			SPARE PART																																										
Code	Description	Image	Code	Description	Kit components																																								
VM2275A	SMOOTH BUSHING		KVM2275A	SMOOTH PIN BUSHING KIT	<table border="1"> <thead> <tr> <th>Code</th> <th>Description</th> <th>Qty</th> <th>UOM</th> </tr> </thead> <tbody> <tr> <td>VM2275A0</td> <td>SMOOTH BUSHING</td> <td>1.000</td> <td>PC</td> </tr> </tbody> </table>	Code	Description	Qty	UOM	VM2275A0	SMOOTH BUSHING	1.000	PC																																
Code	Description	Qty	UOM																																										
VM2275A0	SMOOTH BUSHING	1.000	PC																																										
VT1324A	SP ARIANNA 357x439x4 EXTERNAL GLASS		KVT1324A	BL SHOP.PRO ARIANNA EXTERNAL GLASS KIT	<table border="1"> <thead> <tr> <th>Code</th> <th>Description</th> <th>Qty</th> <th>UOM</th> </tr> </thead> <tbody> <tr> <td>0B0387A0</td> <td>SP ARI-ROS EXT GLASS SUPPORT PROFILE</td> <td>2.000</td> <td>PC</td> </tr> <tr> <td>SL1186A1</td> <td></td> <td>2.000</td> <td>PC</td> </tr> <tr> <td>VI1220A1</td> <td>4,2x12 TCB SELF-TAPPIN G SCREW</td> <td>6.000</td> <td>PC</td> </tr> <tr> <td>VT1324A0</td> <td>SP ARIANNA 357x439x4 EXTERNAL GLASS</td> <td>1.000</td> <td>PC</td> </tr> </tbody> </table>	Code	Description	Qty	UOM	0B0387A0	SP ARI-ROS EXT GLASS SUPPORT PROFILE	2.000	PC	SL1186A1		2.000	PC	VI1220A1	4,2x12 TCB SELF-TAPPIN G SCREW	6.000	PC	VT1324A0	SP ARIANNA 357x439x4 EXTERNAL GLASS	1.000	PC																				
Code	Description	Qty	UOM																																										
0B0387A0	SP ARI-ROS EXT GLASS SUPPORT PROFILE	2.000	PC																																										
SL1186A1		2.000	PC																																										
VI1220A1	4,2x12 TCB SELF-TAPPIN G SCREW	6.000	PC																																										
VT1324A0	SP ARIANNA 357x439x4 EXTERNAL GLASS	1.000	PC																																										
			KDR1287A	BL SHOP.PRO ARIANNA EXTER DOOR KIT LEFT	<table border="1"> <thead> <tr> <th>Code</th> <th>Description</th> <th>Qty</th> <th>UOM</th> </tr> </thead> <tbody> <tr> <td>0B1297A0</td> <td>SP ARI-ROS RIGHT DOOR LEFT EXT COLUMN</td> <td>1.000</td> <td>PC</td> </tr> <tr> <td>0B1298A0</td> <td>SP ARI-ROS RIGHT DOOR LEFT INT COLUMN</td> <td>1.000</td> <td>PC</td> </tr> <tr> <td>0B1299B0</td> <td>SP ARI-ROS RIGHT DOOR RIGHT EXT COLUMN</td> <td>1.000</td> <td>PC</td> </tr> <tr> <td>0B1300A0</td> <td>SP ARI-ROS RIGHT DOOR RIGHT INT COLUMN</td> <td>1.000</td> <td>PC</td> </tr> <tr> <td>CR1040A0</td> <td>DOOR LATCH FOR EL.MECH. LOCKING SYSTEM</td> <td>1.000</td> <td>PC</td> </tr> <tr> <td>ML1005A0</td> <td>DE5 DF0.6 H18 COMPRESSIO N SPRING</td> <td>2.000</td> <td>PC</td> </tr> <tr> <td>SL1186A0</td> <td></td> <td>2.000</td> <td>PC</td> </tr> <tr> <td>TB1562A0</td> <td>DOOR LATERAL BEAM SP600</td> <td>2.000</td> <td>PC</td> </tr> <tr> <td>TB3304A0</td> <td>SHOP.PRO ARI-ROS FLAG DOOR HANDLE TUBE</td> <td>1.000</td> <td>PC</td> </tr> </tbody> </table>	Code	Description	Qty	UOM	0B1297A0	SP ARI-ROS RIGHT DOOR LEFT EXT COLUMN	1.000	PC	0B1298A0	SP ARI-ROS RIGHT DOOR LEFT INT COLUMN	1.000	PC	0B1299B0	SP ARI-ROS RIGHT DOOR RIGHT EXT COLUMN	1.000	PC	0B1300A0	SP ARI-ROS RIGHT DOOR RIGHT INT COLUMN	1.000	PC	CR1040A0	DOOR LATCH FOR EL.MECH. LOCKING SYSTEM	1.000	PC	ML1005A0	DE5 DF0.6 H18 COMPRESSIO N SPRING	2.000	PC	SL1186A0		2.000	PC	TB1562A0	DOOR LATERAL BEAM SP600	2.000	PC	TB3304A0	SHOP.PRO ARI-ROS FLAG DOOR HANDLE TUBE	1.000	PC
Code	Description	Qty	UOM																																										
0B1297A0	SP ARI-ROS RIGHT DOOR LEFT EXT COLUMN	1.000	PC																																										
0B1298A0	SP ARI-ROS RIGHT DOOR LEFT INT COLUMN	1.000	PC																																										
0B1299B0	SP ARI-ROS RIGHT DOOR RIGHT EXT COLUMN	1.000	PC																																										
0B1300A0	SP ARI-ROS RIGHT DOOR RIGHT INT COLUMN	1.000	PC																																										
CR1040A0	DOOR LATCH FOR EL.MECH. LOCKING SYSTEM	1.000	PC																																										
ML1005A0	DE5 DF0.6 H18 COMPRESSIO N SPRING	2.000	PC																																										
SL1186A0		2.000	PC																																										
TB1562A0	DOOR LATERAL BEAM SP600	2.000	PC																																										
TB3304A0	SHOP.PRO ARI-ROS FLAG DOOR HANDLE TUBE	1.000	PC																																										





COMPONENT			SPARE PART																																																																			
Code	Description	Image	Code	Description	Kit components																																																																	
VT1324A	SP ARIANNA 357x439x4 EXTERNAL GLASS		KDR1287A	BL SHOP.PRO ARIANNA EXTER DOOR KIT LEFT	<table border="1"> <thead> <tr> <th>Code</th> <th>Description</th> <th>Qty</th> <th>UOM</th> </tr> </thead> <tbody> <tr> <td>VI1036A0</td> <td>ST STEEL STRIPED THREAD M10 FTT/C INSERT</td> <td>1.000</td> <td>PC</td> </tr> <tr> <td>VI1147A0</td> <td>5X25 STAINLESS STEEL SCREW</td> <td>20.000</td> <td>PC</td> </tr> <tr> <td>VI1220A1</td> <td>4,2x12 TCB SELF-TAPPIN G SCREW</td> <td>14.000</td> <td>PC</td> </tr> <tr> <td>VI1998A0</td> <td>ZINC PLATED SCREW 5X30 TCB</td> <td>2.000</td> <td>PC</td> </tr> <tr> <td>VM1209A0</td> <td>SHOP.PRO LOCK PIN WASHER</td> <td>1.000</td> <td>PC</td> </tr> <tr> <td>VM1630A1</td> <td>INTERNAL GLASS PUSHING CAP</td> <td>4.000</td> <td>PC</td> </tr> <tr> <td>VM2274A0</td> <td>GROOVED BUSHING</td> <td>1.000</td> <td>PC</td> </tr> <tr> <td>VM2275A0</td> <td>SMOOTH BUSHING</td> <td>1.000</td> <td>PC</td> </tr> <tr> <td>VM2456A0</td> <td>BAKERLUX SHOP.PRO HANDLE END</td> <td>1.000</td> <td>PC</td> </tr> <tr> <td>VM2465A0</td> <td>SP SIDE-OPENIN G DOOR RIGHT LOWER CAP KIT</td> <td>1.000</td> <td>PC</td> </tr> <tr> <td>VM2466A0</td> <td>BL SP LEFT LOWER LATERAL DOOR CAP</td> <td>1.000</td> <td>PC</td> </tr> <tr> <td>VM2467A0</td> <td>SP SIDE-OPENIN G DOOR RIGHT UPPER CAP KIT</td> <td>1.000</td> <td>PC</td> </tr> <tr> <td>VM2468A0</td> <td>BL SP LEFT UPPER LATERAL DOOR CAP</td> <td>1.000</td> <td>PC</td> </tr> <tr> <td>VM2470A0</td> <td>SLIDE TO FIX INTERNAL GLASS SHOP.PRO</td> <td>2.000</td> <td>PC</td> </tr> <tr> <td>VM2471A0</td> <td>BL SP LOWER CLAMP INT LOCK GLASS SLIDER</td> <td>1.000</td> <td>PC</td> </tr> </tbody> </table>	Code	Description	Qty	UOM	VI1036A0	ST STEEL STRIPED THREAD M10 FTT/C INSERT	1.000	PC	VI1147A0	5X25 STAINLESS STEEL SCREW	20.000	PC	VI1220A1	4,2x12 TCB SELF-TAPPIN G SCREW	14.000	PC	VI1998A0	ZINC PLATED SCREW 5X30 TCB	2.000	PC	VM1209A0	SHOP.PRO LOCK PIN WASHER	1.000	PC	VM1630A1	INTERNAL GLASS PUSHING CAP	4.000	PC	VM2274A0	GROOVED BUSHING	1.000	PC	VM2275A0	SMOOTH BUSHING	1.000	PC	VM2456A0	BAKERLUX SHOP.PRO HANDLE END	1.000	PC	VM2465A0	SP SIDE-OPENIN G DOOR RIGHT LOWER CAP KIT	1.000	PC	VM2466A0	BL SP LEFT LOWER LATERAL DOOR CAP	1.000	PC	VM2467A0	SP SIDE-OPENIN G DOOR RIGHT UPPER CAP KIT	1.000	PC	VM2468A0	BL SP LEFT UPPER LATERAL DOOR CAP	1.000	PC	VM2470A0	SLIDE TO FIX INTERNAL GLASS SHOP.PRO	2.000	PC	VM2471A0	BL SP LOWER CLAMP INT LOCK GLASS SLIDER	1.000	PC	
Code	Description	Qty	UOM																																																																			
VI1036A0	ST STEEL STRIPED THREAD M10 FTT/C INSERT	1.000	PC																																																																			
VI1147A0	5X25 STAINLESS STEEL SCREW	20.000	PC																																																																			
VI1220A1	4,2x12 TCB SELF-TAPPIN G SCREW	14.000	PC																																																																			
VI1998A0	ZINC PLATED SCREW 5X30 TCB	2.000	PC																																																																			
VM1209A0	SHOP.PRO LOCK PIN WASHER	1.000	PC																																																																			
VM1630A1	INTERNAL GLASS PUSHING CAP	4.000	PC																																																																			
VM2274A0	GROOVED BUSHING	1.000	PC																																																																			
VM2275A0	SMOOTH BUSHING	1.000	PC																																																																			
VM2456A0	BAKERLUX SHOP.PRO HANDLE END	1.000	PC																																																																			
VM2465A0	SP SIDE-OPENIN G DOOR RIGHT LOWER CAP KIT	1.000	PC																																																																			
VM2466A0	BL SP LEFT LOWER LATERAL DOOR CAP	1.000	PC																																																																			
VM2467A0	SP SIDE-OPENIN G DOOR RIGHT UPPER CAP KIT	1.000	PC																																																																			
VM2468A0	BL SP LEFT UPPER LATERAL DOOR CAP	1.000	PC																																																																			
VM2470A0	SLIDE TO FIX INTERNAL GLASS SHOP.PRO	2.000	PC																																																																			
VM2471A0	BL SP LOWER CLAMP INT LOCK GLASS SLIDER	1.000	PC																																																																			



COMPONENT			SPARE PART																																							
Code	Description	Image	Code	Description	Kit components																																					
VT1324A	SP ARIANNA 357x439x4 EXTERNAL GLASS		KDR1287A	BL SHOP.PRO ARIANNA EXTER DOOR KIT LEFT	<table border="1"> <thead> <tr> <th>Code</th> <th>Description</th> <th>Qty</th> <th>UOM</th> </tr> </thead> <tbody> <tr> <td>VM2472A0</td> <td>BL SP UPPER CLAMP INT LOCK GLASS SLIDER</td> <td>1.000</td> <td>PC</td> </tr> <tr> <td>VM2473A0</td> <td>BL SP INT GLASS HINGE LOWER LOCK PIN</td> <td>1.000</td> <td>PC</td> </tr> <tr> <td>VM2474A0</td> <td>BL SP INT GLASS HINGE UPPER LOCK PIN</td> <td>1.000</td> <td>PC</td> </tr> <tr> <td>VM2478A0</td> <td>BL SP GLASS H4 PUSHING BRACKET</td> <td>4.000</td> <td>PC</td> </tr> <tr> <td>VM2489A0</td> <td>SP HANDLE END KIT + STYLUS KIT</td> <td>1.000</td> <td>PC</td> </tr> <tr> <td>VM2504A0</td> <td>DOWEL TO GUIDE SLIDE SPRING SHOP.PRO</td> <td>2.000</td> <td>PC</td> </tr> <tr> <td>VM2527A0</td> <td>STYLUS PEN FOR SP</td> <td>1.000</td> <td>PC</td> </tr> <tr> <td>VT1324A0</td> <td>SP ARIANNA 357x439x4 EXTERNAL GLASS</td> <td></td> <td>1.000</td> <td>PC</td> </tr> </tbody> </table>	Code	Description	Qty	UOM	VM2472A0	BL SP UPPER CLAMP INT LOCK GLASS SLIDER	1.000	PC	VM2473A0	BL SP INT GLASS HINGE LOWER LOCK PIN	1.000	PC	VM2474A0	BL SP INT GLASS HINGE UPPER LOCK PIN	1.000	PC	VM2478A0	BL SP GLASS H4 PUSHING BRACKET	4.000	PC	VM2489A0	SP HANDLE END KIT + STYLUS KIT	1.000	PC	VM2504A0	DOWEL TO GUIDE SLIDE SPRING SHOP.PRO	2.000	PC	VM2527A0	STYLUS PEN FOR SP	1.000	PC	VT1324A0	SP ARIANNA 357x439x4 EXTERNAL GLASS		1.000	PC
			Code	Description	Qty	UOM																																				
VM2472A0	BL SP UPPER CLAMP INT LOCK GLASS SLIDER	1.000	PC																																							
VM2473A0	BL SP INT GLASS HINGE LOWER LOCK PIN	1.000	PC																																							
VM2474A0	BL SP INT GLASS HINGE UPPER LOCK PIN	1.000	PC																																							
VM2478A0	BL SP GLASS H4 PUSHING BRACKET	4.000	PC																																							
VM2489A0	SP HANDLE END KIT + STYLUS KIT	1.000	PC																																							
VM2504A0	DOWEL TO GUIDE SLIDE SPRING SHOP.PRO	2.000	PC																																							
VM2527A0	STYLUS PEN FOR SP	1.000	PC																																							
VT1324A0	SP ARIANNA 357x439x4 EXTERNAL GLASS		1.000	PC																																						
KDR1286A	BL SHOP.PRO ARIANNA EXTERNAL DOOR KI	<table border="1"> <thead> <tr> <th>Code</th> <th>Description</th> <th>Qty</th> <th>UOM</th> </tr> </thead> <tbody> <tr> <td>0B1297A0</td> <td>SP ARI-ROS RIGHT DOOR LEFT EXT COLUMN</td> <td>1.000</td> <td>PC</td> </tr> <tr> <td>0B1298A0</td> <td>SP ARI-ROS RIGHT DOOR LEFT INT COLUMN</td> <td>1.000</td> <td>PC</td> </tr> <tr> <td>0B1299B0</td> <td>SP ARI-ROS RIGHT DOOR RIGHT EXT COLUMN</td> <td>1.000</td> <td>PC</td> </tr> <tr> <td>0B1300A0</td> <td>SP ARI-ROS RIGHT DOOR RIGHT INT COLUMN</td> <td>1.000</td> <td>PC</td> </tr> <tr> <td>CR1040A0</td> <td>DOOR LATCH FOR EL.MECH. LOCKING SYSTEM</td> <td>1.000</td> <td>PC</td> </tr> <tr> <td>ML1005A0</td> <td>DES DF0.6 H18 COMPRESSIO N SPRING</td> <td>2.000</td> <td>PC</td> </tr> <tr> <td>SL1186A0</td> <td></td> <td>2.000</td> <td>PC</td> </tr> </tbody> </table>	Code	Description	Qty	UOM	0B1297A0	SP ARI-ROS RIGHT DOOR LEFT EXT COLUMN	1.000	PC	0B1298A0	SP ARI-ROS RIGHT DOOR LEFT INT COLUMN	1.000	PC	0B1299B0	SP ARI-ROS RIGHT DOOR RIGHT EXT COLUMN	1.000	PC	0B1300A0	SP ARI-ROS RIGHT DOOR RIGHT INT COLUMN	1.000	PC	CR1040A0	DOOR LATCH FOR EL.MECH. LOCKING SYSTEM	1.000	PC	ML1005A0	DES DF0.6 H18 COMPRESSIO N SPRING	2.000	PC	SL1186A0		2.000	PC								
Code	Description	Qty	UOM																																							
0B1297A0	SP ARI-ROS RIGHT DOOR LEFT EXT COLUMN	1.000	PC																																							
0B1298A0	SP ARI-ROS RIGHT DOOR LEFT INT COLUMN	1.000	PC																																							
0B1299B0	SP ARI-ROS RIGHT DOOR RIGHT EXT COLUMN	1.000	PC																																							
0B1300A0	SP ARI-ROS RIGHT DOOR RIGHT INT COLUMN	1.000	PC																																							
CR1040A0	DOOR LATCH FOR EL.MECH. LOCKING SYSTEM	1.000	PC																																							
ML1005A0	DES DF0.6 H18 COMPRESSIO N SPRING	2.000	PC																																							
SL1186A0		2.000	PC																																							



COMPONENT			SPARE PART																																																																						
Code	Description	Image	Code	Description	Kit components																																																																				
VT1324A	SP ARIANNA 357x439x4 EXTERNAL GLASS		KDR1286A	BL SHOP.PRO ARIANNA EXTERNAL DOOR KI	<table border="1"> <thead> <tr> <th>Code</th> <th>Description</th> <th>Qty</th> <th>UOM</th> </tr> </thead> <tbody> <tr> <td>TB1562A0</td> <td>DOOR LATERAL BEAM SP600</td> <td>2.000</td> <td>PC</td> </tr> <tr> <td>TB3304A0</td> <td>SHOP.PRO ARI-ROS FLAG DOOR HANDLE TUBE</td> <td>1.000</td> <td>PC</td> </tr> <tr> <td>VI1036A0</td> <td>ST STEEL STRIPED THREAD M10 FTT/C INSERT</td> <td>1.000</td> <td>PC</td> </tr> <tr> <td>VI1147A0</td> <td>5X25 STAINLESS STEEL SCREW</td> <td>20.000</td> <td>PC</td> </tr> <tr> <td>VI1220A1</td> <td>4,2x12 TCB SELF-TAPPIN G SCREW</td> <td>14.000</td> <td>PC</td> </tr> <tr> <td>VI1998A0</td> <td>ZINC PLATED SCREW 5X30 TCB</td> <td>2.000</td> <td>PC</td> </tr> <tr> <td>VM1209A0</td> <td>SHOP.PRO LOCK PIN WASHER</td> <td>1.000</td> <td>PC</td> </tr> <tr> <td>VM1630A1</td> <td>INTERNAL GLASS PUSHING CAP</td> <td>4.000</td> <td>PC</td> </tr> <tr> <td>VM2274A0</td> <td>GROOVED BUSHING</td> <td>1.000</td> <td>PC</td> </tr> <tr> <td>VM2275A0</td> <td>SMOOTH BUSHING</td> <td>1.000</td> <td>PC</td> </tr> <tr> <td>VM2456A0</td> <td>BAKERLUX SHOP.PRO HANDLE END</td> <td>1.000</td> <td>PC</td> </tr> <tr> <td>VM2465A0</td> <td>SP SIDE-OPENIN G DOOR RIGHT LOWER CAP KIT</td> <td>1.000</td> <td>PC</td> </tr> <tr> <td>VM2466A0</td> <td>BL SP LEFT LOWER LATERAL DOOR CAP</td> <td>1.000</td> <td>PC</td> </tr> <tr> <td>VM2467A0</td> <td>SP SIDE-OPENIN G DOOR RIGHT UPPER CAP KIT</td> <td>1.000</td> <td>PC</td> </tr> <tr> <td>VM2468A0</td> <td>BL SP LEFT UPPER LATERAL DOOR CAP</td> <td>1.000</td> <td>PC</td> </tr> <tr> <td>VM2470A0</td> <td>SLIDE TO FIX INTERNAL GLASS SHOP.PRO</td> <td>2.000</td> <td>PC</td> </tr> </tbody> </table>	Code	Description	Qty	UOM	TB1562A0	DOOR LATERAL BEAM SP600	2.000	PC	TB3304A0	SHOP.PRO ARI-ROS FLAG DOOR HANDLE TUBE	1.000	PC	VI1036A0	ST STEEL STRIPED THREAD M10 FTT/C INSERT	1.000	PC	VI1147A0	5X25 STAINLESS STEEL SCREW	20.000	PC	VI1220A1	4,2x12 TCB SELF-TAPPIN G SCREW	14.000	PC	VI1998A0	ZINC PLATED SCREW 5X30 TCB	2.000	PC	VM1209A0	SHOP.PRO LOCK PIN WASHER	1.000	PC	VM1630A1	INTERNAL GLASS PUSHING CAP	4.000	PC	VM2274A0	GROOVED BUSHING	1.000	PC	VM2275A0	SMOOTH BUSHING	1.000	PC	VM2456A0	BAKERLUX SHOP.PRO HANDLE END	1.000	PC	VM2465A0	SP SIDE-OPENIN G DOOR RIGHT LOWER CAP KIT	1.000	PC	VM2466A0	BL SP LEFT LOWER LATERAL DOOR CAP	1.000	PC	VM2467A0	SP SIDE-OPENIN G DOOR RIGHT UPPER CAP KIT	1.000	PC	VM2468A0	BL SP LEFT UPPER LATERAL DOOR CAP	1.000	PC	VM2470A0	SLIDE TO FIX INTERNAL GLASS SHOP.PRO	2.000	PC
Code	Description	Qty	UOM																																																																						
TB1562A0	DOOR LATERAL BEAM SP600	2.000	PC																																																																						
TB3304A0	SHOP.PRO ARI-ROS FLAG DOOR HANDLE TUBE	1.000	PC																																																																						
VI1036A0	ST STEEL STRIPED THREAD M10 FTT/C INSERT	1.000	PC																																																																						
VI1147A0	5X25 STAINLESS STEEL SCREW	20.000	PC																																																																						
VI1220A1	4,2x12 TCB SELF-TAPPIN G SCREW	14.000	PC																																																																						
VI1998A0	ZINC PLATED SCREW 5X30 TCB	2.000	PC																																																																						
VM1209A0	SHOP.PRO LOCK PIN WASHER	1.000	PC																																																																						
VM1630A1	INTERNAL GLASS PUSHING CAP	4.000	PC																																																																						
VM2274A0	GROOVED BUSHING	1.000	PC																																																																						
VM2275A0	SMOOTH BUSHING	1.000	PC																																																																						
VM2456A0	BAKERLUX SHOP.PRO HANDLE END	1.000	PC																																																																						
VM2465A0	SP SIDE-OPENIN G DOOR RIGHT LOWER CAP KIT	1.000	PC																																																																						
VM2466A0	BL SP LEFT LOWER LATERAL DOOR CAP	1.000	PC																																																																						
VM2467A0	SP SIDE-OPENIN G DOOR RIGHT UPPER CAP KIT	1.000	PC																																																																						
VM2468A0	BL SP LEFT UPPER LATERAL DOOR CAP	1.000	PC																																																																						
VM2470A0	SLIDE TO FIX INTERNAL GLASS SHOP.PRO	2.000	PC																																																																						





COMPONENT			SPARE PART																																											
Code	Description	Image	Code	Description	Kit components																																									
VT1324A	SP ARIANNA 357x439x4 EXTERNAL GLASS		KDR1286A	BL SHOP.PRO ARIANNA EXTERNAL DOOR KI	<table border="1"> <thead> <tr> <th>Code</th> <th>Description</th> <th>Qty</th> <th>UOM</th> </tr> </thead> <tbody> <tr> <td>VM2471A0</td> <td>BL SP LOWER CLAMP INT LOCK GLASS SLIDER</td> <td>1.000</td> <td>PC</td> </tr> <tr> <td>VM2472A0</td> <td>BL SP UPPER CLAMP INT LOCK GLASS SLIDER</td> <td>1.000</td> <td>PC</td> </tr> <tr> <td>VM2473A0</td> <td>BL SP INT GLASS HINGE LOWER LOCK PIN</td> <td>1.000</td> <td>PC</td> </tr> <tr> <td>VM2474A0</td> <td>BL SP INT GLASS HINGE UPPER LOCK PIN</td> <td>1.000</td> <td>PC</td> </tr> <tr> <td>VM2478A0</td> <td>BL SP GLASS H4 PUSHING BRACKET</td> <td>4.000</td> <td>PC</td> </tr> <tr> <td>VM2489A0</td> <td>SP HANDLE END KIT + STYLUS KIT</td> <td>1.000</td> <td>PC</td> </tr> <tr> <td>VM2504A0</td> <td>DOWEL TO GUIDE SLIDE SPRING SHOP.PRO</td> <td>2.000</td> <td>PC</td> </tr> <tr> <td>VM2527A0</td> <td>STYLUS PEN FOR SP</td> <td>1.000</td> <td>PC</td> </tr> <tr> <td>VT1324A0</td> <td>SP ARIANNA 357x439x4 EXTERNAL GLASS</td> <td></td> <td>1.000</td> <td>PC</td> </tr> </tbody> </table>	Code	Description	Qty	UOM	VM2471A0	BL SP LOWER CLAMP INT LOCK GLASS SLIDER	1.000	PC	VM2472A0	BL SP UPPER CLAMP INT LOCK GLASS SLIDER	1.000	PC	VM2473A0	BL SP INT GLASS HINGE LOWER LOCK PIN	1.000	PC	VM2474A0	BL SP INT GLASS HINGE UPPER LOCK PIN	1.000	PC	VM2478A0	BL SP GLASS H4 PUSHING BRACKET	4.000	PC	VM2489A0	SP HANDLE END KIT + STYLUS KIT	1.000	PC	VM2504A0	DOWEL TO GUIDE SLIDE SPRING SHOP.PRO	2.000	PC	VM2527A0	STYLUS PEN FOR SP	1.000	PC	VT1324A0	SP ARIANNA 357x439x4 EXTERNAL GLASS		1.000	PC
			Code	Description	Qty	UOM																																								
VM2471A0	BL SP LOWER CLAMP INT LOCK GLASS SLIDER	1.000	PC																																											
VM2472A0	BL SP UPPER CLAMP INT LOCK GLASS SLIDER	1.000	PC																																											
VM2473A0	BL SP INT GLASS HINGE LOWER LOCK PIN	1.000	PC																																											
VM2474A0	BL SP INT GLASS HINGE UPPER LOCK PIN	1.000	PC																																											
VM2478A0	BL SP GLASS H4 PUSHING BRACKET	4.000	PC																																											
VM2489A0	SP HANDLE END KIT + STYLUS KIT	1.000	PC																																											
VM2504A0	DOWEL TO GUIDE SLIDE SPRING SHOP.PRO	2.000	PC																																											
VM2527A0	STYLUS PEN FOR SP	1.000	PC																																											
VT1324A0	SP ARIANNA 357x439x4 EXTERNAL GLASS		1.000	PC																																										
KDR1281A	SP ARIANNA COMPLETE DROP DOWN DOOR KIT	<table border="1"> <thead> <tr> <th>Code</th> <th>Description</th> <th>Qty</th> <th>UOM</th> </tr> </thead> <tbody> <tr> <td>0B1289A0</td> <td>SP ARI-ROS DROPDOWN DOOR LEFT EXT COLUMN</td> <td>1.000</td> <td>PC</td> </tr> <tr> <td>0B1290A0</td> <td>SP ARI-ROS DROPDOWN DOOR LEFT INT COLUMN</td> <td>1.000</td> <td>PC</td> </tr> <tr> <td>0B1291A0</td> <td>SP ARI-ROS DROPDOWN DOOR RT EXT COLUMN</td> <td>1.000</td> <td>PC</td> </tr> <tr> <td>0B1292A0</td> <td>SP ARI-ROS DROPDOWN DOOR RT INNER COLUM</td> <td>1.000</td> <td>PC</td> </tr> <tr> <td>CR1112A1</td> <td></td> <td>2.000</td> <td>PC</td> </tr> <tr> <td>LP1050A0</td> <td>BL SHOP.PRO L180 COMPLETE LED BAR</td> <td>1.000</td> <td>PC</td> </tr> </tbody> </table>	Code	Description	Qty	UOM	0B1289A0	SP ARI-ROS DROPDOWN DOOR LEFT EXT COLUMN	1.000	PC	0B1290A0	SP ARI-ROS DROPDOWN DOOR LEFT INT COLUMN	1.000	PC	0B1291A0	SP ARI-ROS DROPDOWN DOOR RT EXT COLUMN	1.000	PC	0B1292A0	SP ARI-ROS DROPDOWN DOOR RT INNER COLUM	1.000	PC	CR1112A1		2.000	PC	LP1050A0	BL SHOP.PRO L180 COMPLETE LED BAR	1.000	PC																
Code	Description	Qty	UOM																																											
0B1289A0	SP ARI-ROS DROPDOWN DOOR LEFT EXT COLUMN	1.000	PC																																											
0B1290A0	SP ARI-ROS DROPDOWN DOOR LEFT INT COLUMN	1.000	PC																																											
0B1291A0	SP ARI-ROS DROPDOWN DOOR RT EXT COLUMN	1.000	PC																																											
0B1292A0	SP ARI-ROS DROPDOWN DOOR RT INNER COLUM	1.000	PC																																											
CR1112A1		2.000	PC																																											
LP1050A0	BL SHOP.PRO L180 COMPLETE LED BAR	1.000	PC																																											



COMPONENT			SPARE PART																																																																										
Code	Description	Image	Code	Description	Kit components																																																																								
VT1324A	SP ARIANNA 357x439x4 EXTERNAL GLASS		KDR1281A	SP ARIANNA COMPLETE DROP DOWN DOOR KIT	<table border="1"> <thead> <tr> <th>Code</th> <th>Description</th> <th>Qty</th> <th>UOM</th> </tr> </thead> <tbody> <tr> <td>SL1186A0</td> <td></td> <td>2.000</td> <td>PC</td> </tr> <tr> <td>TB1562A0</td> <td>DOOR LATERAL BEAM SP600</td> <td>1.000</td> <td>PC</td> </tr> <tr> <td>TB3301A0</td> <td></td> <td>1.000</td> <td>PC</td> </tr> <tr> <td>VI1014A0</td> <td>STAINLESS STEEL WASHER 4.5X9X0.8</td> <td>1.000</td> <td>PC</td> </tr> <tr> <td>VI1147A0</td> <td>5X25 STAINLESS STEEL SCREW</td> <td>10.000</td> <td>PC</td> </tr> <tr> <td>VI1220A1</td> <td>4,2x12 TCB SELF-TAPPIN G SCREW</td> <td>10.000</td> <td>PC</td> </tr> <tr> <td>VI1280A3</td> <td>M5x10 TC1/2T SCREW</td> <td>6.000</td> <td>PC</td> </tr> <tr> <td>VI1998A0</td> <td>ZINC PLATED SCREW 5X30 TCB</td> <td>2.000</td> <td>PC</td> </tr> <tr> <td>VM1630A1</td> <td>INTERNAL GLASS PUSHING CAP</td> <td>1.000</td> <td>PC</td> </tr> <tr> <td>VM2456A0</td> <td>BAKERLUX SHOP.PRO HANDLE END</td> <td>1.000</td> <td>PC</td> </tr> <tr> <td>VM2461A0</td> <td>BL SP RIGHT LOWER DROPDOWN DOOR CAP KIT</td> <td>1.000</td> <td>PC</td> </tr> <tr> <td>VM2462A0</td> <td>BL SP LEFT LOWER DROPDOWN DOOR CAP</td> <td>1.000</td> <td>PC</td> </tr> <tr> <td>VM2463A0</td> <td>SHOP.PRO RIGHT UPPER CAP DROP DOWN DOOR</td> <td>1.000</td> <td>PC</td> </tr> <tr> <td>VM2464A0</td> <td>SHOP.PRO LEFT UPPER CAP DROP DOWN DOOR</td> <td>1.000</td> <td>PC</td> </tr> <tr> <td>VM2471A0</td> <td>BL SP LOWER CLAMP INT LOCK GLASS SLIDER</td> <td>1.000</td> <td>PC</td> </tr> <tr> <td>VM2472A0</td> <td>BL SP UPPER CLAMP INT LOCK GLASS SLIDER</td> <td>1.000</td> <td>PC</td> </tr> <tr> <td>VM2478A0</td> <td>BL SP GLASS H4 PUSHING BRACKET</td> <td>1.000</td> <td>PC</td> </tr> </tbody> </table>	Code	Description	Qty	UOM	SL1186A0		2.000	PC	TB1562A0	DOOR LATERAL BEAM SP600	1.000	PC	TB3301A0		1.000	PC	VI1014A0	STAINLESS STEEL WASHER 4.5X9X0.8	1.000	PC	VI1147A0	5X25 STAINLESS STEEL SCREW	10.000	PC	VI1220A1	4,2x12 TCB SELF-TAPPIN G SCREW	10.000	PC	VI1280A3	M5x10 TC1/2T SCREW	6.000	PC	VI1998A0	ZINC PLATED SCREW 5X30 TCB	2.000	PC	VM1630A1	INTERNAL GLASS PUSHING CAP	1.000	PC	VM2456A0	BAKERLUX SHOP.PRO HANDLE END	1.000	PC	VM2461A0	BL SP RIGHT LOWER DROPDOWN DOOR CAP KIT	1.000	PC	VM2462A0	BL SP LEFT LOWER DROPDOWN DOOR CAP	1.000	PC	VM2463A0	SHOP.PRO RIGHT UPPER CAP DROP DOWN DOOR	1.000	PC	VM2464A0	SHOP.PRO LEFT UPPER CAP DROP DOWN DOOR	1.000	PC	VM2471A0	BL SP LOWER CLAMP INT LOCK GLASS SLIDER	1.000	PC	VM2472A0	BL SP UPPER CLAMP INT LOCK GLASS SLIDER	1.000	PC	VM2478A0	BL SP GLASS H4 PUSHING BRACKET	1.000	PC
Code	Description	Qty	UOM																																																																										
SL1186A0		2.000	PC																																																																										
TB1562A0	DOOR LATERAL BEAM SP600	1.000	PC																																																																										
TB3301A0		1.000	PC																																																																										
VI1014A0	STAINLESS STEEL WASHER 4.5X9X0.8	1.000	PC																																																																										
VI1147A0	5X25 STAINLESS STEEL SCREW	10.000	PC																																																																										
VI1220A1	4,2x12 TCB SELF-TAPPIN G SCREW	10.000	PC																																																																										
VI1280A3	M5x10 TC1/2T SCREW	6.000	PC																																																																										
VI1998A0	ZINC PLATED SCREW 5X30 TCB	2.000	PC																																																																										
VM1630A1	INTERNAL GLASS PUSHING CAP	1.000	PC																																																																										
VM2456A0	BAKERLUX SHOP.PRO HANDLE END	1.000	PC																																																																										
VM2461A0	BL SP RIGHT LOWER DROPDOWN DOOR CAP KIT	1.000	PC																																																																										
VM2462A0	BL SP LEFT LOWER DROPDOWN DOOR CAP	1.000	PC																																																																										
VM2463A0	SHOP.PRO RIGHT UPPER CAP DROP DOWN DOOR	1.000	PC																																																																										
VM2464A0	SHOP.PRO LEFT UPPER CAP DROP DOWN DOOR	1.000	PC																																																																										
VM2471A0	BL SP LOWER CLAMP INT LOCK GLASS SLIDER	1.000	PC																																																																										
VM2472A0	BL SP UPPER CLAMP INT LOCK GLASS SLIDER	1.000	PC																																																																										
VM2478A0	BL SP GLASS H4 PUSHING BRACKET	1.000	PC																																																																										



COMPONENT			SPARE PART																														
Code	Description	Image	Code	Description	Kit components																												
VT1324A	SP ARIANNA 357x439x4 EXTERNAL GLASS		KDR1281A	SP ARIANNA COMPLETE DROP DOWN DOOR KIT	<table border="1"> <thead> <tr> <th>Code</th> <th>Description</th> <th>Qty</th> <th>UOM</th> </tr> </thead> <tbody> <tr> <td>VM2489A0</td> <td>SP HANDLE END KIT + STYLUS KIT</td> <td>1.000</td> <td>PC</td> </tr> <tr> <td>VM2503A0</td> <td>SLIDE TO FIX INTERNAL NON REMOV GLASS SP</td> <td>2.000</td> <td>PC</td> </tr> <tr> <td>VM2512A0</td> <td>BL SP DOOR-MICRO SWITCH SOFT CLOSING</td> <td>1.000</td> <td>PC</td> </tr> <tr> <td>VM2527A0</td> <td>STYLUS PEN FOR SP</td> <td>1.000</td> <td>PC</td> </tr> <tr> <td>VT1324A0</td> <td>SP ARIANNA 357x439x4 EXTERNAL GLASS</td> <td>1.000</td> <td>PC</td> </tr> <tr> <td>VT1330A0</td> <td>SP ARIANNA 515x393.5x4 INNER GLASS</td> <td>1.000</td> <td>PC</td> </tr> </tbody> </table>	Code	Description	Qty	UOM	VM2489A0	SP HANDLE END KIT + STYLUS KIT	1.000	PC	VM2503A0	SLIDE TO FIX INTERNAL NON REMOV GLASS SP	2.000	PC	VM2512A0	BL SP DOOR-MICRO SWITCH SOFT CLOSING	1.000	PC	VM2527A0	STYLUS PEN FOR SP	1.000	PC	VT1324A0	SP ARIANNA 357x439x4 EXTERNAL GLASS	1.000	PC	VT1330A0	SP ARIANNA 515x393.5x4 INNER GLASS	1.000	PC
					Code	Description	Qty	UOM																									
					VM2489A0	SP HANDLE END KIT + STYLUS KIT	1.000	PC																									
					VM2503A0	SLIDE TO FIX INTERNAL NON REMOV GLASS SP	2.000	PC																									
					VM2512A0	BL SP DOOR-MICRO SWITCH SOFT CLOSING	1.000	PC																									
					VM2527A0	STYLUS PEN FOR SP	1.000	PC																									
					VT1324A0	SP ARIANNA 357x439x4 EXTERNAL GLASS	1.000	PC																									
VT1330A0	SP ARIANNA 515x393.5x4 INNER GLASS	1.000	PC																														
VT1345A	SP ARIANNA FLAG DOOR INNER GLASS+HINGES		KVT1345A	BL SP ARIANNA R/L INT GLASS KIT	<table border="1"> <thead> <tr> <th>Code</th> <th>Description</th> <th>Qty</th> <th>UOM</th> </tr> </thead> <tbody> <tr> <td>CR1103A0</td> <td>INTERNAL GLASS ST. STEEL UPPER HINGE</td> <td>1.000</td> <td>PC</td> </tr> <tr> <td>CR1104A0</td> <td>INTERNAL GLASS ST. STEEL LOWER HINGE</td> <td>1.000</td> <td>PC</td> </tr> <tr> <td>VI1810A0</td> <td>M6X6 STAINLESS STEEL FLATHEAD SCREW</td> <td>6.000</td> <td>PC</td> </tr> <tr> <td>VM2399A0</td> <td>DOOR HINGES HEADLESS SCREWS COVER</td> <td>2.000</td> <td>PC</td> </tr> <tr> <td>VM2475A0</td> <td>SP H4 INTERNAL GLASS HINGE INSERT</td> <td>2.000</td> <td>PC</td> </tr> <tr> <td>VT1330A0</td> <td>SP ARIANNA 515x393.5x4 INNER GLASS</td> <td>1.000</td> <td>PC</td> </tr> </tbody> </table>	Code	Description	Qty	UOM	CR1103A0	INTERNAL GLASS ST. STEEL UPPER HINGE	1.000	PC	CR1104A0	INTERNAL GLASS ST. STEEL LOWER HINGE	1.000	PC	VI1810A0	M6X6 STAINLESS STEEL FLATHEAD SCREW	6.000	PC	VM2399A0	DOOR HINGES HEADLESS SCREWS COVER	2.000	PC	VM2475A0	SP H4 INTERNAL GLASS HINGE INSERT	2.000	PC	VT1330A0	SP ARIANNA 515x393.5x4 INNER GLASS	1.000	PC
					Code	Description	Qty	UOM																									
					CR1103A0	INTERNAL GLASS ST. STEEL UPPER HINGE	1.000	PC																									
					CR1104A0	INTERNAL GLASS ST. STEEL LOWER HINGE	1.000	PC																									
					VI1810A0	M6X6 STAINLESS STEEL FLATHEAD SCREW	6.000	PC																									
					VM2399A0	DOOR HINGES HEADLESS SCREWS COVER	2.000	PC																									
					VM2475A0	SP H4 INTERNAL GLASS HINGE INSERT	2.000	PC																									
VT1330A0	SP ARIANNA 515x393.5x4 INNER GLASS	1.000	PC																														

**ASM3438A/0.D01 - Electrical system**

**FRONT**

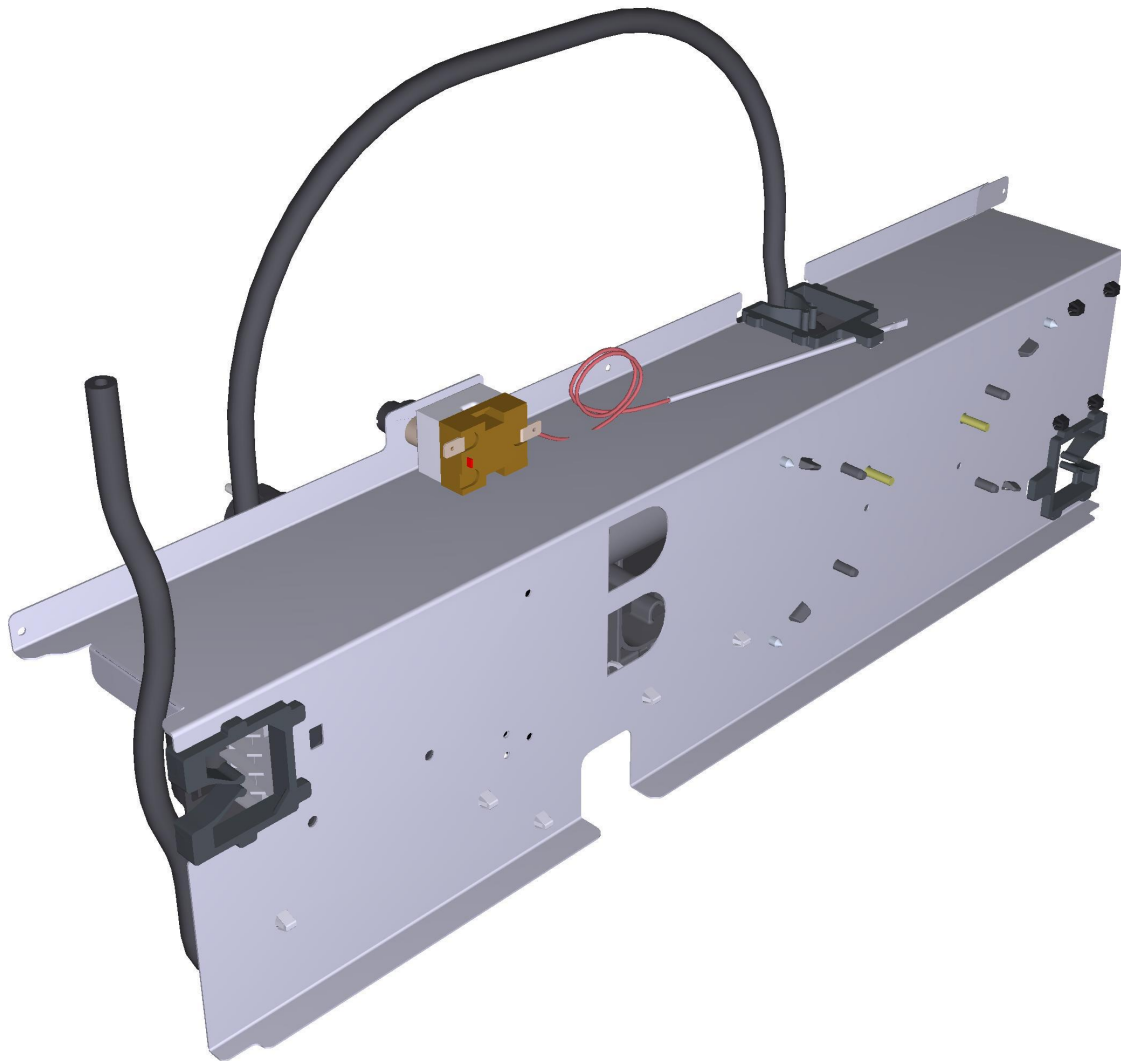



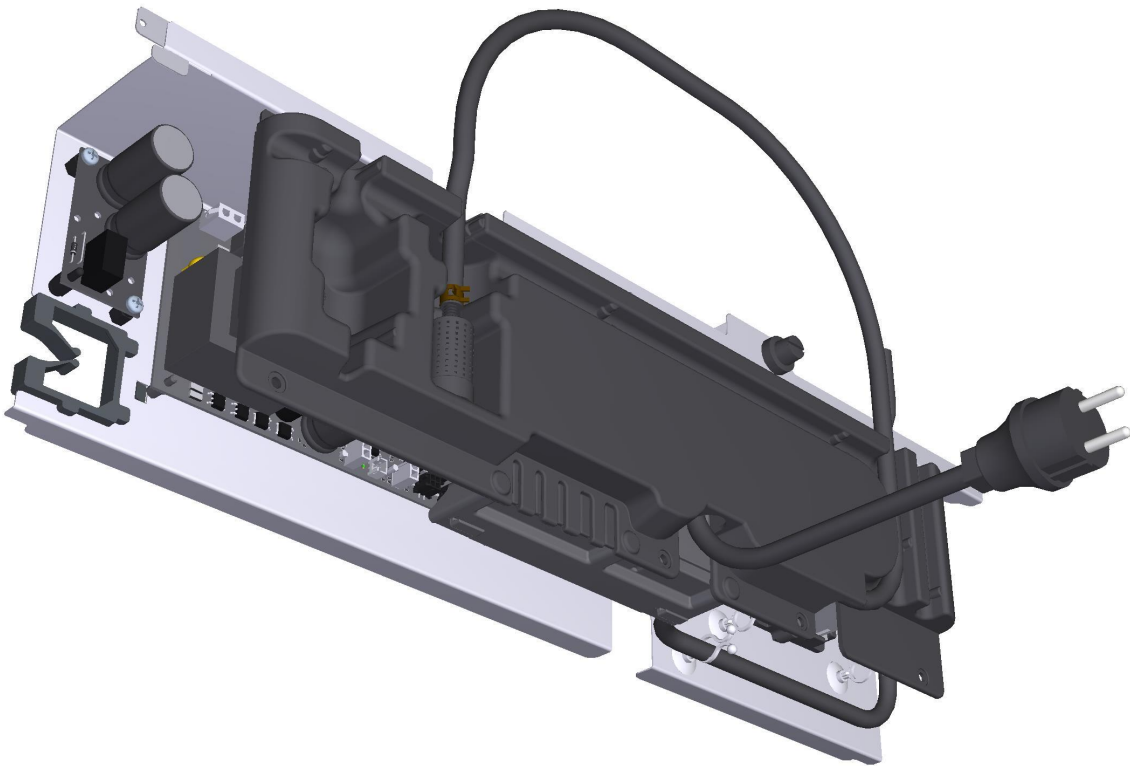

**ASM3438A/0.D01 - Electrical system**

**REAR**





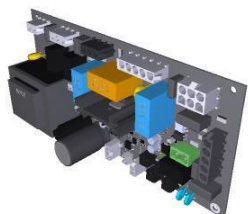





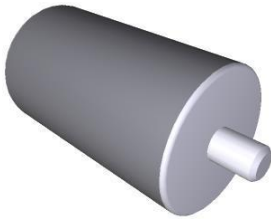

COMPONENT			SPARE PART																		
Code	Description	Image	Code	Description	Kit components																
0P1021A	COMPONENTS HOLDING PANEL STE-ARI SP		0P1021A0	COMPONENTS HOLDING PANEL STE-ARI SP																	
VE1115A	20 A 230V 4 POLES MINICONTRACTOR		KVE1115A	20A 230V 4 POLES MINICONTRACTOR KI	<table border="1"> <thead> <tr> <th>Code</th> <th>Description</th> <th>Qty</th> <th>UOM</th> </tr> </thead> <tbody> <tr> <td>VE1115A0</td> <td>20 A 230V 4 POLES MINICONTRACT OR</td> <td>1.000</td> <td>PC</td> </tr> <tr> <td>VM1075A1</td> <td>PLASTIC CLIP TO FIX CONTACTORS</td> <td>4.000</td> <td>PC</td> </tr> </tbody> </table>	Code	Description	Qty	UOM	VE1115A0	20 A 230V 4 POLES MINICONTRACT OR	1.000	PC	VM1075A1	PLASTIC CLIP TO FIX CONTACTORS	4.000	PC				
Code	Description	Qty	UOM																		
VE1115A0	20 A 230V 4 POLES MINICONTRACT OR	1.000	PC																		
VM1075A1	PLASTIC CLIP TO FIX CONTACTORS	4.000	PC																		
VM1056A	SMALL CONTACTOR BRACKET VE1115A		VM1056A0	SMALL CONTACTOR BRACKET VE1115A																	
PE2102A	BL LED/TOUCH/PLUS 230 V POWER CARD		KPE2102A	BL LED/TOUCH/MASTE R 230V POWER CARD KIT	<table border="1"> <thead> <tr> <th>Code</th> <th>Description</th> <th>Qty</th> <th>UOM</th> </tr> </thead> <tbody> <tr> <td>PE2102A2</td> <td>BL LED/TOUCH/P LUS 230V POWER BOAR</td> <td>1.000</td> <td>PC</td> </tr> <tr> <td>V11988A0</td> <td>AUTOTHREAD ING SCREW 4,2x19 TCB+ INOX</td> <td>3.000</td> <td>PC</td> </tr> <tr> <td>VM1187A0</td> <td>POWER BOARD FRAME SHOP.PRO</td> <td>1.000</td> <td>PC</td> </tr> </tbody> </table>	Code	Description	Qty	UOM	PE2102A2	BL LED/TOUCH/P LUS 230V POWER BOAR	1.000	PC	V11988A0	AUTOTHREAD ING SCREW 4,2x19 TCB+ INOX	3.000	PC	VM1187A0	POWER BOARD FRAME SHOP.PRO	1.000	PC
Code	Description	Qty	UOM																		
PE2102A2	BL LED/TOUCH/P LUS 230V POWER BOAR	1.000	PC																		
V11988A0	AUTOTHREAD ING SCREW 4,2x19 TCB+ INOX	3.000	PC																		
VM1187A0	POWER BOARD FRAME SHOP.PRO	1.000	PC																		
VM1187A	POWER BOARD FRAME SHOP.PRO		VM1187A0	POWER BOARD FRAME SHOP.PRO																	

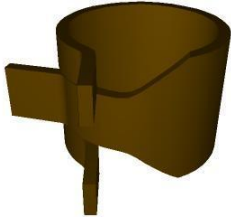
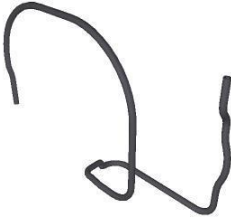
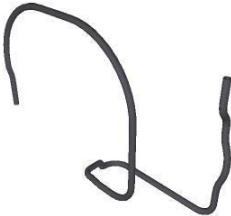

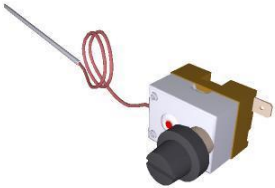
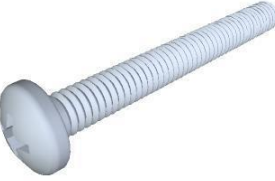
COMPONENT			SPARE PART																						
Code	Description	Image	Code	Description	Kit components																				
PE2117A	BLSP ELECTROMECHANICAL LOCK BOARD		KPE2117A	ELECTRIC LOCKING SYSTEM BOARD KIT 230V	<table border="1"> <thead> <tr> <th>Code</th> <th>Description</th> <th>Qty</th> <th>UOM</th> </tr> </thead> <tbody> <tr> <td>PE2117A0</td> <td>BLSP ELECTROMECHANICAL LOCK BOARD</td> <td>1.000</td> <td>PC</td> </tr> <tr> <td>V11850A0</td> <td>TCB M4x6 SCREW</td> <td>2.000</td> <td>PC</td> </tr> <tr> <td>VM1746A0</td> <td>H10 M4 JOINT BOARD FASTENING CLIP</td> <td>2.000</td> <td>PC</td> </tr> <tr> <td>VM1747A0</td> <td>JOINT-PIN H10 POWER BOARD FASTENING CLIP</td> <td>2.000</td> <td>PC</td> </tr> </tbody> </table>	Code	Description	Qty	UOM	PE2117A0	BLSP ELECTROMECHANICAL LOCK BOARD	1.000	PC	V11850A0	TCB M4x6 SCREW	2.000	PC	VM1746A0	H10 M4 JOINT BOARD FASTENING CLIP	2.000	PC	VM1747A0	JOINT-PIN H10 POWER BOARD FASTENING CLIP	2.000	PC
					Code	Description	Qty	UOM																	
					PE2117A0	BLSP ELECTROMECHANICAL LOCK BOARD	1.000	PC																	
					V11850A0	TCB M4x6 SCREW	2.000	PC																	
VM1746A0	H10 M4 JOINT BOARD FASTENING CLIP	2.000	PC																						
VM1747A0	JOINT-PIN H10 POWER BOARD FASTENING CLIP	2.000	PC																						
<table border="1"> <thead> <tr> <th>Code</th> <th>Description</th> <th>Qty</th> <th>UOM</th> </tr> </thead> <tbody> <tr> <td>VM1746A0</td> <td>H10 M4 JOINT BOARD FASTENING CLIP</td> <td>10.000</td> <td>PC</td> </tr> </tbody> </table>	Code	Description	Qty	UOM	VM1746A0	H10 M4 JOINT BOARD FASTENING CLIP	10.000	PC																	
Code	Description	Qty	UOM																						
VM1746A0	H10 M4 JOINT BOARD FASTENING CLIP	10.000	PC																						
<table border="1"> <thead> <tr> <th>Code</th> <th>Description</th> <th>Qty</th> <th>UOM</th> </tr> </thead> <tbody> <tr> <td>VM1747A0</td> <td>JOINT-PIN H10 POWER BOARD FASTENING CLIP</td> <td>10.000</td> <td>PC</td> </tr> </tbody> </table>	Code	Description	Qty	UOM	VM1747A0	JOINT-PIN H10 POWER BOARD FASTENING CLIP	10.000	PC																	
Code	Description	Qty	UOM																						
VM1747A0	JOINT-PIN H10 POWER BOARD FASTENING CLIP	10.000	PC																						
<table border="1"> <thead> <tr> <th>Code</th> <th>Description</th> <th>Qty</th> <th>UOM</th> </tr> </thead> <tbody> <tr> <td>CE1581A0</td> <td>CABLE H07RNF 3G1.5 L1.5MT+K1/6+SCHU KO</td> <td>1.000</td> <td>PC</td> </tr> </tbody> </table>	Code	Description	Qty	UOM	CE1581A0	CABLE H07RNF 3G1.5 L1.5MT+K1/6+SCHU KO	1.000	PC																	
Code	Description	Qty	UOM																						
CE1581A0	CABLE H07RNF 3G1.5 L1.5MT+K1/6+SCHU KO	1.000	PC																						
VM1746A	H10 M4 JOINT BOARD FASTENING CLIP		KVM1746A	BOARD FIXING CLIP JOINT-M4 KIT	<table border="1"> <thead> <tr> <th>Code</th> <th>Description</th> <th>Qty</th> <th>UOM</th> </tr> </thead> <tbody> <tr> <td>VM1746A0</td> <td>H10 M4 JOINT BOARD FASTENING CLIP</td> <td>10.000</td> <td>PC</td> </tr> </tbody> </table>	Code	Description	Qty	UOM	VM1746A0	H10 M4 JOINT BOARD FASTENING CLIP	10.000	PC												
Code	Description	Qty	UOM																						
VM1746A0	H10 M4 JOINT BOARD FASTENING CLIP	10.000	PC																						
VM1747A	JOINT-PIN H10 POWER BOARD FASTENING CLIP		KVM1747A	BOARD FIXING CLIP JOINT-PIN KIT	<table border="1"> <thead> <tr> <th>Code</th> <th>Description</th> <th>Qty</th> <th>UOM</th> </tr> </thead> <tbody> <tr> <td>VM1747A0</td> <td>JOINT-PIN H10 POWER BOARD FASTENING CLIP</td> <td>10.000</td> <td>PC</td> </tr> </tbody> </table>	Code	Description	Qty	UOM	VM1747A0	JOINT-PIN H10 POWER BOARD FASTENING CLIP	10.000	PC												
Code	Description	Qty	UOM																						
VM1747A0	JOINT-PIN H10 POWER BOARD FASTENING CLIP	10.000	PC																						
CE1581A	CABLE H07RNF 3G1.5 L1.5MT+K1/6+SCHU KO		KCE1581A	H07RNF 3G1.5 L1.5 MT + SHUKO PLUG KIT	<table border="1"> <thead> <tr> <th>Code</th> <th>Description</th> <th>Qty</th> <th>UOM</th> </tr> </thead> <tbody> <tr> <td>CE1581A0</td> <td>CABLE H07RNF 3G1.5 L1.5MT+K1/6+ SCHUKO</td> <td>1.000</td> <td>PC</td> </tr> </tbody> </table>	Code	Description	Qty	UOM	CE1581A0	CABLE H07RNF 3G1.5 L1.5MT+K1/6+ SCHUKO	1.000	PC												
Code	Description	Qty	UOM																						
CE1581A0	CABLE H07RNF 3G1.5 L1.5MT+K1/6+ SCHUKO	1.000	PC																						

COMPONENT			SPARE PART																		
Code	Description	Image	Code	Description	Kit components																
CN1003A	6,3 Uf MOTOR CAPACITOR		KCN1003A	6,3 uF MOTOR CAPACITOR KIT	<table border="1"> <thead> <tr> <th>Code</th> <th>Description</th> <th>Qty</th> <th>UOM</th> </tr> </thead> <tbody> <tr> <td>CN1003A0</td> <td>6,3 Uf MOTOR CAPACITOR</td> <td>1.000</td> <td>PC</td> </tr> <tr> <td>VI1931A0</td> <td>M8x1.65 H4 CH13 ZINC PLATED NUT</td> <td>1.000</td> <td>PC</td> </tr> <tr> <td>VI1932A0</td> <td>D8 INDENTED ZINC PLATED WASHER</td> <td>1.000</td> <td>PC</td> </tr> </tbody> </table>	Code	Description	Qty	UOM	CN1003A0	6,3 Uf MOTOR CAPACITOR	1.000	PC	VI1931A0	M8x1.65 H4 CH13 ZINC PLATED NUT	1.000	PC	VI1932A0	D8 INDENTED ZINC PLATED WASHER	1.000	PC
Code	Description	Qty	UOM																		
CN1003A0	6,3 Uf MOTOR CAPACITOR	1.000	PC																		
VI1931A0	M8x1.65 H4 CH13 ZINC PLATED NUT	1.000	PC																		
VI1932A0	D8 INDENTED ZINC PLATED WASHER	1.000	PC																		
MR1025A	3 POLES 450V 41A+GROUND TERMINAL BLOCK		KMR1025A	3 POLES TERMINAL BLOCK KIT	<table border="1"> <thead> <tr> <th>Code</th> <th>Description</th> <th>Qty</th> <th>UOM</th> </tr> </thead> <tbody> <tr> <td>MR1025A1</td> <td>3 POLES 450V 41A+GROUND TERMINAL BLOCK</td> <td>1.000</td> <td>PC</td> </tr> </tbody> </table>	Code	Description	Qty	UOM	MR1025A1	3 POLES 450V 41A+GROUND TERMINAL BLOCK	1.000	PC								
Code	Description	Qty	UOM																		
MR1025A1	3 POLES 450V 41A+GROUND TERMINAL BLOCK	1.000	PC																		
RC1019A	D=10 ELASTIC CLAM		KRC1019A	Ø10 ZINC PLATED ELASTIC CLAMP 15 PCS KIT	<table border="1"> <thead> <tr> <th>Code</th> <th>Description</th> <th>Qty</th> <th>UOM</th> </tr> </thead> <tbody> <tr> <td>RC1019A0</td> <td>D=10 ELASTIC CLAMP</td> <td>15.000</td> <td>PC</td> </tr> </tbody> </table>	Code	Description	Qty	UOM	RC1019A0	D=10 ELASTIC CLAMP	15.000	PC								
Code	Description	Qty	UOM																		
RC1019A0	D=10 ELASTIC CLAMP	15.000	PC																		
TB1628A	2300mm 4,5x10 EPDM PIPE - TB3314		KTB2678A	4.5X10 NSF 3M EPDM TUBE KIT	<table border="1"> <thead> <tr> <th>Code</th> <th>Description</th> <th>Qty</th> <th>UOM</th> </tr> </thead> <tbody> <tr> <td>TB3314A0</td> <td>4.5X10 NSF EPDM TUBE</td> <td>3.000</td> <td>M</td> </tr> </tbody> </table>	Code	Description	Qty	UOM	TB3314A0	4.5X10 NSF EPDM TUBE	3.000	M								
Code	Description	Qty	UOM																		
TB3314A0	4.5X10 NSF EPDM TUBE	3.000	M																		
TB1628A	TB1628A0		KTB2678A	4.5X10 NSF 3M EPDM TUBE KIT	<table border="1"> <thead> <tr> <th>Code</th> <th>Description</th> <th>Qty</th> <th>UOM</th> </tr> </thead> <tbody> <tr> <td>TB3314A0</td> <td>4.5X10 NSF EPDM TUBE</td> <td>3.000</td> <td>M</td> </tr> </tbody> </table>	Code	Description	Qty	UOM	TB3314A0	4.5X10 NSF EPDM TUBE	3.000	M								
Code	Description	Qty	UOM																		
TB3314A0	4.5X10 NSF EPDM TUBE	3.000	M																		

COMPONENT			SPARE PART																																						
Code	Description	Image	Code	Description	Kit components																																				
TR1136A	318°C -0/+24 1 POLE SAFETY THERMOSTAT		KTR1136A	318°C -0/+24 SAFETY THERMOSTAT KIT	<table border="1"> <thead> <tr> <th>Code</th> <th>Description</th> <th>Qty</th> <th>UOM</th> </tr> </thead> <tbody> <tr> <td>0H7030A0</td> <td>THERMOSTAT BULB INLET COVER</td> <td>1.000</td> <td>PC</td> </tr> <tr> <td>GN1531A0</td> <td>THERMOSTAT BULB INLET SEALING</td> <td>1.000</td> <td>PC</td> </tr> <tr> <td>SL1045A0</td> <td>S57 BLACK SILICONE - 80ml CARTRIDGE</td> <td>1.000</td> <td>PC</td> </tr> <tr> <td>TR1136A0</td> <td>318°C -0/+24 1 POLE SAFETY THERMOSTAT</td> <td>1.000</td> <td>PC</td> </tr> <tr> <td>VI1220A1</td> <td>4,2x12 TCB SELF-TAPPING SCREW</td> <td>3.000</td> <td>PC</td> </tr> </tbody> </table>	Code	Description	Qty	UOM	0H7030A0	THERMOSTAT BULB INLET COVER	1.000	PC	GN1531A0	THERMOSTAT BULB INLET SEALING	1.000	PC	SL1045A0	S57 BLACK SILICONE - 80ml CARTRIDGE	1.000	PC	TR1136A0	318°C -0/+24 1 POLE SAFETY THERMOSTAT	1.000	PC	VI1220A1	4,2x12 TCB SELF-TAPPING SCREW	3.000	PC												
Code	Description	Qty	UOM																																						
0H7030A0	THERMOSTAT BULB INLET COVER	1.000	PC																																						
GN1531A0	THERMOSTAT BULB INLET SEALING	1.000	PC																																						
SL1045A0	S57 BLACK SILICONE - 80ml CARTRIDGE	1.000	PC																																						
TR1136A0	318°C -0/+24 1 POLE SAFETY THERMOSTAT	1.000	PC																																						
VI1220A1	4,2x12 TCB SELF-TAPPING SCREW	3.000	PC																																						
VI1328A	VI1328A0		VI1328A0	VI1328A0																																					
VL1044B	D6.2-8.2 HOLD DOWN WEIGHT + NET FILTER		KVL1044B	DETERGENT FEEDER WITH HOLD DOWN KIT	<table border="1"> <thead> <tr> <th>Code</th> <th>Description</th> <th>Qty</th> <th>UOM</th> </tr> </thead> <tbody> <tr> <td>EL1348A0</td> <td>CLIP TO FIX Ø6 CONNECTION</td> <td>1.000</td> <td>PC</td> </tr> <tr> <td>RC1008A0</td> <td>D9 ELASTIC CLIP</td> <td>1.000</td> <td>PC</td> </tr> <tr> <td>RC1373A0</td> <td>Ø6F-Ø6F ELBOW FITTING</td> <td>1.000</td> <td>PC</td> </tr> <tr> <td>TB2242B0</td> <td>WASHING SYSTEM 9x6 PIPE</td> <td>1.000</td> <td>PC</td> </tr> <tr> <td>VL1041C0</td> <td>DETERGENT CAP WITH Ø12 HOLE</td> <td>1.000</td> <td>PC</td> </tr> <tr> <td>VL1044B0</td> <td>D6.2-8.2 HOLD DOWN WEIGHT + NET FILTER</td> <td>1.000</td> <td>PC</td> </tr> <tr> <td>VL1046A1</td> <td>D6 PIPE HOLDER - D6 J.G. TERMINAL</td> <td>1.000</td> <td>PC</td> </tr> <tr> <td>VM1088A0</td> <td>NYLON CLICK CLAMP D7.9-D9.2</td> <td>2.000</td> <td>PC</td> </tr> </tbody> </table>	Code	Description	Qty	UOM	EL1348A0	CLIP TO FIX Ø6 CONNECTION	1.000	PC	RC1008A0	D9 ELASTIC CLIP	1.000	PC	RC1373A0	Ø6F-Ø6F ELBOW FITTING	1.000	PC	TB2242B0	WASHING SYSTEM 9x6 PIPE	1.000	PC	VL1041C0	DETERGENT CAP WITH Ø12 HOLE	1.000	PC	VL1044B0	D6.2-8.2 HOLD DOWN WEIGHT + NET FILTER	1.000	PC	VL1046A1	D6 PIPE HOLDER - D6 J.G. TERMINAL	1.000	PC	VM1088A0	NYLON CLICK CLAMP D7.9-D9.2	2.000	PC
Code	Description	Qty	UOM																																						
EL1348A0	CLIP TO FIX Ø6 CONNECTION	1.000	PC																																						
RC1008A0	D9 ELASTIC CLIP	1.000	PC																																						
RC1373A0	Ø6F-Ø6F ELBOW FITTING	1.000	PC																																						
TB2242B0	WASHING SYSTEM 9x6 PIPE	1.000	PC																																						
VL1041C0	DETERGENT CAP WITH Ø12 HOLE	1.000	PC																																						
VL1044B0	D6.2-8.2 HOLD DOWN WEIGHT + NET FILTER	1.000	PC																																						
VL1046A1	D6 PIPE HOLDER - D6 J.G. TERMINAL	1.000	PC																																						
VM1088A0	NYLON CLICK CLAMP D7.9-D9.2	2.000	PC																																						

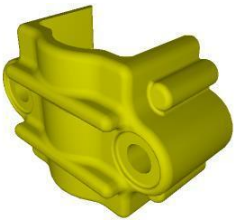
COMPONENT			SPARE PART																		
Code	Description	Image	Code	Description	Kit components																
VM1188A	POWER BOARD WIRES PASS-THROUGH		KVM1188A	POWER BOARD WIRES PASS-THROUGH 10PCS KIT	<table border="1"> <thead> <tr> <th>Code</th> <th>Description</th> <th>Qty</th> <th>UOM</th> </tr> </thead> <tbody> <tr> <td>VM1188A0</td> <td>POWER BOARD WIRES PASS-THROUGH</td> <td>10.000</td> <td>PC</td> </tr> </tbody> </table>	Code	Description	Qty	UOM	VM1188A0	POWER BOARD WIRES PASS-THROUGH	10.000	PC								
Code	Description	Qty	UOM																		
VM1188A0	POWER BOARD WIRES PASS-THROUGH	10.000	PC																		
VM2482A	ELECTR COMPONENTS HOLDER FRAME SHOP.PRO		KVM2482A	BAKERLUX SP ELECTR COMPONENTS HOLDER KIT	<table border="1"> <thead> <tr> <th>Code</th> <th>Description</th> <th>Qty</th> <th>UOM</th> </tr> </thead> <tbody> <tr> <td>VM2482A0</td> <td>ELECTR COMPONENT S HOLDER FRAME SHOP.PRO</td> <td>1.000</td> <td>PC</td> </tr> <tr> <td>VM2484A0</td> <td>ELECTRICAL CONNECTION CABLE CLAMP</td> <td>1.000</td> <td>PC</td> </tr> </tbody> </table>	Code	Description	Qty	UOM	VM2482A0	ELECTR COMPONENT S HOLDER FRAME SHOP.PRO	1.000	PC	VM2484A0	ELECTRICAL CONNECTION CABLE CLAMP	1.000	PC				
Code	Description	Qty	UOM																		
VM2482A0	ELECTR COMPONENT S HOLDER FRAME SHOP.PRO	1.000	PC																		
VM2484A0	ELECTRICAL CONNECTION CABLE CLAMP	1.000	PC																		
VM2483A	SHOP PRO COMPONENTS HOLDER COVER		KVM2483A	BL SHOP.PRO COMPONENTS HOLDER COVER KIT	<table border="1"> <thead> <tr> <th>Code</th> <th>Description</th> <th>Qty</th> <th>UOM</th> </tr> </thead> <tbody> <tr> <td>VM2483A1</td> <td>SHOP PRO COMPONENT S HOLDER COVER</td> <td>1.000</td> <td>PC</td> </tr> </tbody> </table>	Code	Description	Qty	UOM	VM2483A1	SHOP PRO COMPONENT S HOLDER COVER	1.000	PC								
Code	Description	Qty	UOM																		
VM2483A1	SHOP PRO COMPONENT S HOLDER COVER	1.000	PC																		
VM2484A	ELECTRICAL CONNECTION CABLE CLAMP		KVM2484A KVM2482A	CABLE LOCKS ELECTRICAL CONNECTION KIT  BAKERLUX SP ELECTR COMPONENTS HOLDER KIT	<table border="1"> <thead> <tr> <th>Code</th> <th>Description</th> <th>Qty</th> <th>UOM</th> </tr> </thead> <tbody> <tr> <td>VM2484A0</td> <td>ELECTRICAL CONNECTION CABLE CLAMP</td> <td>1.000</td> <td>PC</td> </tr> <tr> <td>VM2482A0</td> <td>ELECTR COMPONENT S HOLDER FRAME SHOP.PRO</td> <td>1.000</td> <td>PC</td> </tr> <tr> <td>VM2484A0</td> <td>ELECTRICAL CONNECTION CABLE CLAMP</td> <td>1.000</td> <td>PC</td> </tr> </tbody> </table>	Code	Description	Qty	UOM	VM2484A0	ELECTRICAL CONNECTION CABLE CLAMP	1.000	PC	VM2482A0	ELECTR COMPONENT S HOLDER FRAME SHOP.PRO	1.000	PC	VM2484A0	ELECTRICAL CONNECTION CABLE CLAMP	1.000	PC
Code	Description	Qty	UOM																		
VM2484A0	ELECTRICAL CONNECTION CABLE CLAMP	1.000	PC																		
VM2482A0	ELECTR COMPONENT S HOLDER FRAME SHOP.PRO	1.000	PC																		
VM2484A0	ELECTRICAL CONNECTION CABLE CLAMP	1.000	PC																		