







Assembly code	Assembly description	Assembly image
ASM3401A/0.D01	Cooking chamber	
ASM3407A/0.D01	External cover	
ASM3419A/0.D00	Door	
ASM3438A/0.D01	Electrical system	



ASM3401A/0.D01 - Cooking chamber

FRONT

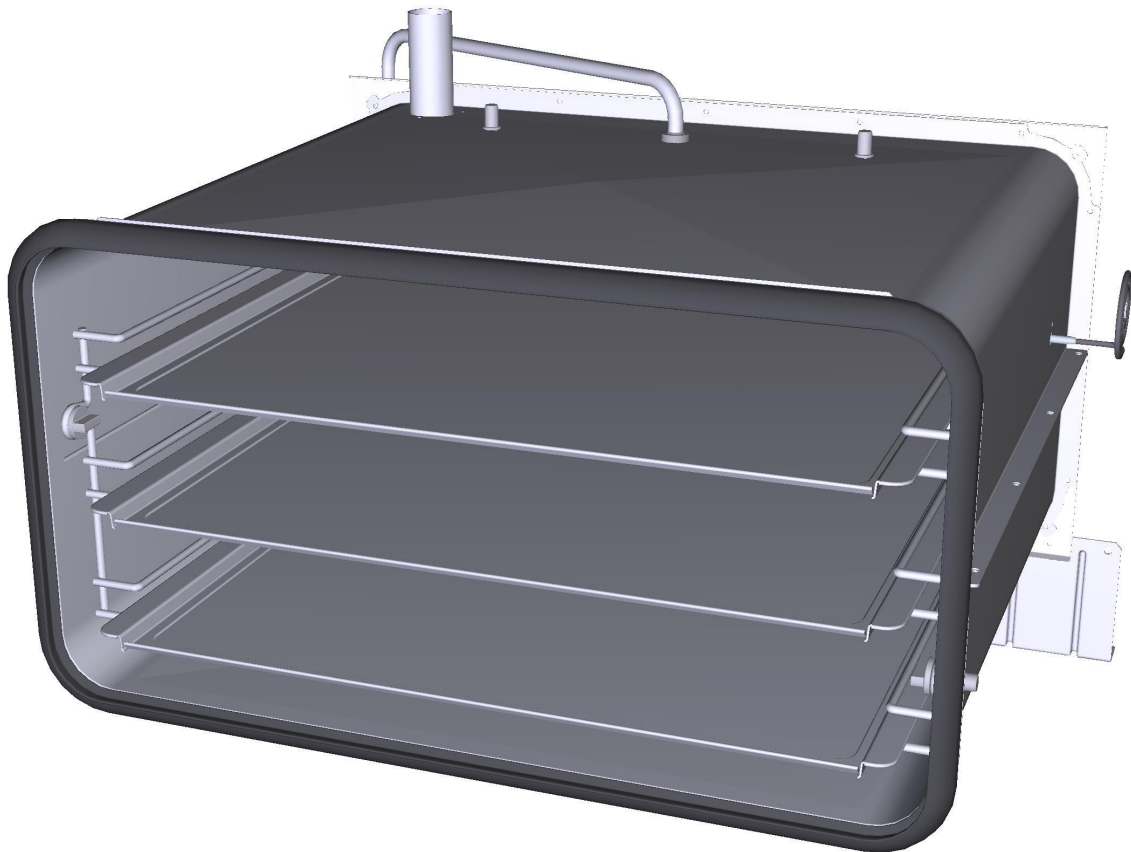





ASM3401A/0.D01 - Cooking chamber

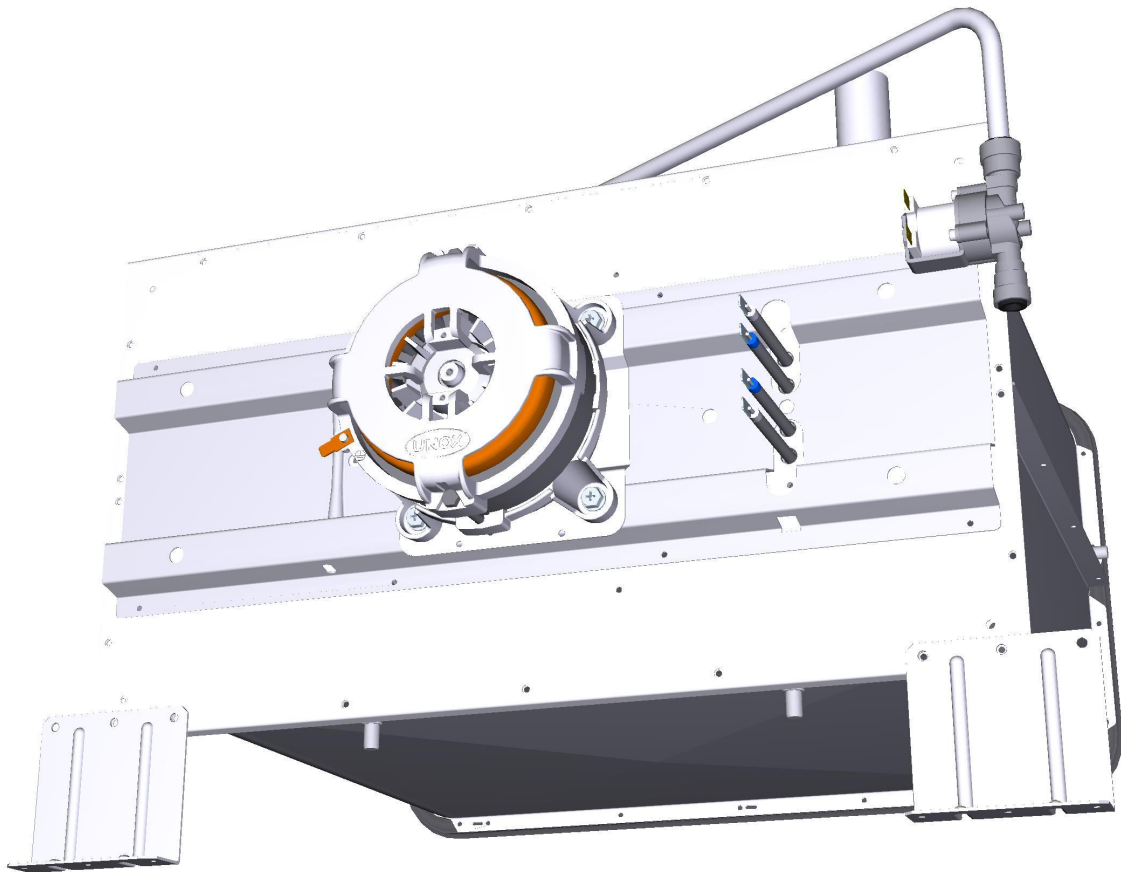



REAR







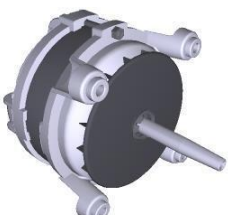

COMPONENT			SPARE PART																																						
Code	Description	Image	Code	Description	Kit components																																				
0G1651B	STEFANIA SP FAN GUARD		0G1651B0	STEFANIA SP FAN GUARD																																					
0H7875A	SHOP.PRO MUFFLE SUPPORT BRACKET		0H7875A0	SHOP.PRO MUFFLE SUPPORT BRACKET																																					
TR1105A	L1000 PT100 TEMPERATURE PROBE		KTR1105A	PT100 L1000 TEMPERATURE PROBE KIT	<table border="1"> <thead> <tr> <th>Code</th> <th>Description</th> <th>Qty</th> <th>UOM</th> </tr> </thead> <tbody> <tr> <td>GN1120A1</td> <td>NTC TEMPERATUR E PROBE SEAL</td> <td>1.000</td> <td>PC</td> </tr> <tr> <td>GN1285A0</td> <td>NTC TEMPERATUR E PROBE SEALING</td> <td>1.000</td> <td>PC</td> </tr> <tr> <td>SL1045A0</td> <td>S57 BLACK SILICONE - 80ml CARTRIDGE</td> <td>1.000</td> <td>PC</td> </tr> <tr> <td>TR1105A4</td> <td>L1000 PT100 TEMPERATUR E PROBE</td> <td>1.000</td> <td>PC</td> </tr> <tr> <td>VI1220A1</td> <td>4,2x12 TCB SELF-TAPPIN G SCREW</td> <td>2.000</td> <td>PC</td> </tr> <tr> <td>VM1464A1</td> <td>CT BT TEMPERATUR E PROBE COVER</td> <td>1.000</td> <td>PC</td> </tr> <tr> <td>VM1465A1</td> <td>CT BT TEMPERATUR E PROBE COVER</td> <td>1.000</td> <td>PC</td> </tr> <tr> <td>VM2052A0</td> <td>LM CORE PROBE COVE</td> <td>1.000</td> <td>PC</td> </tr> </tbody> </table>	Code	Description	Qty	UOM	GN1120A1	NTC TEMPERATUR E PROBE SEAL	1.000	PC	GN1285A0	NTC TEMPERATUR E PROBE SEALING	1.000	PC	SL1045A0	S57 BLACK SILICONE - 80ml CARTRIDGE	1.000	PC	TR1105A4	L1000 PT100 TEMPERATUR E PROBE	1.000	PC	VI1220A1	4,2x12 TCB SELF-TAPPIN G SCREW	2.000	PC	VM1464A1	CT BT TEMPERATUR E PROBE COVER	1.000	PC	VM1465A1	CT BT TEMPERATUR E PROBE COVER	1.000	PC	VM2052A0	LM CORE PROBE COVE	1.000	PC
Code	Description	Qty	UOM																																						
GN1120A1	NTC TEMPERATUR E PROBE SEAL	1.000	PC																																						
GN1285A0	NTC TEMPERATUR E PROBE SEALING	1.000	PC																																						
SL1045A0	S57 BLACK SILICONE - 80ml CARTRIDGE	1.000	PC																																						
TR1105A4	L1000 PT100 TEMPERATUR E PROBE	1.000	PC																																						
VI1220A1	4,2x12 TCB SELF-TAPPIN G SCREW	2.000	PC																																						
VM1464A1	CT BT TEMPERATUR E PROBE COVER	1.000	PC																																						
VM1465A1	CT BT TEMPERATUR E PROBE COVER	1.000	PC																																						
VM2052A0	LM CORE PROBE COVE	1.000	PC																																						

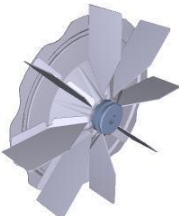

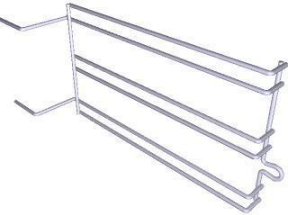
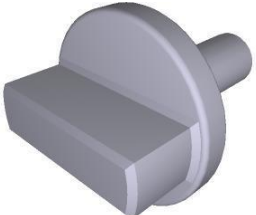

COMPONENT			SPARE PART																		
Code	Description	Image	Code	Description	Kit components																
EL1251A	1-WAY WATER SOLENOID VALVE		KEL1251A	JG D8-D10 1 WAY SOLENOID VALVE KI	<table border="1"> <thead> <tr> <th>Code</th> <th>Description</th> <th>Qty</th> <th>UOM</th> </tr> </thead> <tbody> <tr> <td>EL1251A0</td> <td>1-WAY WATER SOLENOID VALVE</td> <td>1.000</td> <td>PC</td> </tr> </tbody> </table>	Code	Description	Qty	UOM	EL1251A0	1-WAY WATER SOLENOID VALVE	1.000	PC								
Code	Description	Qty	UOM																		
EL1251A0	1-WAY WATER SOLENOID VALVE	1.000	PC																		
0H3020A	MOTOR SHAFT SEALING DISC		0H3020A1	MOTOR SHAFT SEALING DISC																	
0H7170A	MM MOTOR GLASS WOOL PLATE		0H7170A0	MM MOTOR GLASS WOOL PLATE																	
GN1547A	SHAFT GASKET D11.8		KGN1547A	D11.6 MOTOR SHAFT GASKET 3PCS KIT	<table border="1"> <thead> <tr> <th>Code</th> <th>Description</th> <th>Qty</th> <th>UOM</th> </tr> </thead> <tbody> <tr> <td>GN1547A1</td> <td>SHAFT GASKET D11.8</td> <td>3.000</td> <td>PC</td> </tr> </tbody> </table>	Code	Description	Qty	UOM	GN1547A1	SHAFT GASKET D11.8	3.000	PC								
Code	Description	Qty	UOM																		
GN1547A1	SHAFT GASKET D11.8	3.000	PC																		
MT1012A	330W 230V MOTOR		KVN1130A	LUX ≤08.2017/L.MISS/S.5/ 5E MOTOR KIT	<table border="1"> <thead> <tr> <th>Code</th> <th>Description</th> <th>Qty</th> <th>UOM</th> </tr> </thead> <tbody> <tr> <td>0H4305A1</td> <td>ST. STEEL MOTOR SHAFT SEALING DISC</td> <td>1.000</td> <td>PC</td> </tr> <tr> <td>GN1140A3</td> <td>MOLDED MOTOR HOLDER GASKET</td> <td>1.000</td> <td>PC</td> </tr> <tr> <td>V11034A0</td> <td>STAINLESS STEEL WASHER 8.4x16x1</td> <td>1.000</td> <td>PC</td> </tr> </tbody> </table>	Code	Description	Qty	UOM	0H4305A1	ST. STEEL MOTOR SHAFT SEALING DISC	1.000	PC	GN1140A3	MOLDED MOTOR HOLDER GASKET	1.000	PC	V11034A0	STAINLESS STEEL WASHER 8.4x16x1	1.000	PC
Code	Description	Qty	UOM																		
0H4305A1	ST. STEEL MOTOR SHAFT SEALING DISC	1.000	PC																		
GN1140A3	MOLDED MOTOR HOLDER GASKET	1.000	PC																		
V11034A0	STAINLESS STEEL WASHER 8.4x16x1	1.000	PC																		

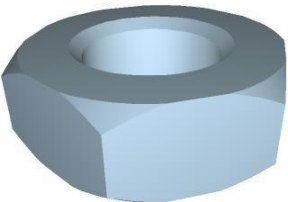
COMPONENT			SPARE PART																																							
Code	Description	Image	Code	Description	Kit components																																					
MT1012A	330W 230V MOTOR		KVN1130A	LUX ≤08.2017/L.MISS/S.5/ 5E MOTOR KIT	<table border="1"> <thead> <tr> <th>Code</th> <th>Description</th> <th>Qty</th> <th>UOM</th> </tr> </thead> <tbody> <tr> <td>VI1256A0</td> <td>M8 DIN 980M ST. STEEL SELF LOCKING NUT</td> <td>1.000</td> <td>PC</td> </tr> <tr> <td>VM2196A0</td> <td>MOTOR NUT FASTENING BUSHING</td> <td>1.000</td> <td>PC</td> </tr> <tr> <td>VN1130A1</td> <td>330W 230V 50/60HZ MOTO</td> <td>1.000</td> <td>PC</td> </tr> </tbody> </table>	Code	Description	Qty	UOM	VI1256A0	M8 DIN 980M ST. STEEL SELF LOCKING NUT	1.000	PC	VM2196A0	MOTOR NUT FASTENING BUSHING	1.000	PC	VN1130A1	330W 230V 50/60HZ MOTO	1.000	PC																					
			Code	Description	Qty	UOM																																				
VI1256A0	M8 DIN 980M ST. STEEL SELF LOCKING NUT	1.000	PC																																							
VM2196A0	MOTOR NUT FASTENING BUSHING	1.000	PC																																							
VN1130A1	330W 230V 50/60HZ MOTO	1.000	PC																																							
KMT1012A	LUX >08.2017 / MIND.MAPS 330W MOTOR KIT	<table border="1"> <thead> <tr> <th>Code</th> <th>Description</th> <th>Qty</th> <th>UOM</th> </tr> </thead> <tbody> <tr> <td>0H2842A0</td> <td>MT1012 CENTERING JI</td> <td>1.000</td> <td>PC</td> </tr> <tr> <td>0H4305A1</td> <td>ST. STEEL MOTOR SHAFT SEALING DISC</td> <td>1.000</td> <td>PC</td> </tr> <tr> <td>GN1140A3</td> <td>MOLDED MOTOR HOLDER GASKET</td> <td>1.000</td> <td>PC</td> </tr> <tr> <td>MT1012A0</td> <td>330W 230V MOTOR</td> <td>1.000</td> <td>PC</td> </tr> <tr> <td>VE1550A0</td> <td>5X3 MM NEODYMIUM MAGNET</td> <td>1.000</td> <td>PC</td> </tr> <tr> <td>VI1077A1</td> <td>SCREW M6x12 TE INOX</td> <td>1.000</td> <td>PC</td> </tr> <tr> <td>VI1521A0</td> <td>STAINLESS STEEL WASHER D=6 6592</td> <td>1.000</td> <td>PC</td> </tr> <tr> <td>VI1966A0</td> <td>M4X14 FLATHEAD SCREW</td> <td>1.000</td> <td>PC</td> </tr> <tr> <td>VM1635A0</td> <td>MAGNET HOLDING DIS</td> <td>1.000</td> <td>PC</td> </tr> </tbody> </table>	Code	Description	Qty	UOM	0H2842A0	MT1012 CENTERING JI	1.000	PC	0H4305A1	ST. STEEL MOTOR SHAFT SEALING DISC	1.000	PC	GN1140A3	MOLDED MOTOR HOLDER GASKET	1.000	PC	MT1012A0	330W 230V MOTOR	1.000	PC	VE1550A0	5X3 MM NEODYMIUM MAGNET	1.000	PC	VI1077A1	SCREW M6x12 TE INOX	1.000	PC	VI1521A0	STAINLESS STEEL WASHER D=6 6592	1.000	PC	VI1966A0	M4X14 FLATHEAD SCREW	1.000	PC	VM1635A0	MAGNET HOLDING DIS	1.000	PC
Code	Description	Qty	UOM																																							
0H2842A0	MT1012 CENTERING JI	1.000	PC																																							
0H4305A1	ST. STEEL MOTOR SHAFT SEALING DISC	1.000	PC																																							
GN1140A3	MOLDED MOTOR HOLDER GASKET	1.000	PC																																							
MT1012A0	330W 230V MOTOR	1.000	PC																																							
VE1550A0	5X3 MM NEODYMIUM MAGNET	1.000	PC																																							
VI1077A1	SCREW M6x12 TE INOX	1.000	PC																																							
VI1521A0	STAINLESS STEEL WASHER D=6 6592	1.000	PC																																							
VI1966A0	M4X14 FLATHEAD SCREW	1.000	PC																																							
VM1635A0	MAGNET HOLDING DIS	1.000	PC																																							
VN1172A	M8 NUT 8 BLADES H40 D195 FAN		KVN1172A	D195 H40 M8 NUT 8 BLADES FAN KIT	<table border="1"> <thead> <tr> <th>Code</th> <th>Description</th> <th>Qty</th> <th>UOM</th> </tr> </thead> <tbody> <tr> <td>VI1077A1</td> <td>SCREW M6x12 TE INOX</td> <td>1.000</td> <td>PC</td> </tr> <tr> <td>VI1521A0</td> <td>STAINLESS STEEL WASHER D=6 6592</td> <td>1.000</td> <td>PC</td> </tr> <tr> <td>VN1172A0</td> <td>M8 NUT 8 BLADES H40 D195 FAN</td> <td>1.000</td> <td>PC</td> </tr> </tbody> </table>	Code	Description	Qty	UOM	VI1077A1	SCREW M6x12 TE INOX	1.000	PC	VI1521A0	STAINLESS STEEL WASHER D=6 6592	1.000	PC	VN1172A0	M8 NUT 8 BLADES H40 D195 FAN	1.000	PC																					
Code	Description	Qty	UOM																																							
VI1077A1	SCREW M6x12 TE INOX	1.000	PC																																							
VI1521A0	STAINLESS STEEL WASHER D=6 6592	1.000	PC																																							
VN1172A0	M8 NUT 8 BLADES H40 D195 FAN	1.000	PC																																							

COMPONENT			SPARE PART																						
Code	Description	Image	Code	Description	Kit components																				
RS1282A	2700W 230V+210W 160V 4TURNS H60 ELEMENT		KRS1282B	4TURN HEAT ELEM 2700W 230V+260W 135V KIT	<table border="1"> <thead> <tr> <th>Code</th> <th>Description</th> <th>Qty</th> <th>UOM</th> </tr> </thead> <tbody> <tr> <td>GN1327A0</td> <td>HEATING ELEMENT GASKET</td> <td>1.000</td> <td>PC</td> </tr> <tr> <td>RS1282B0</td> <td></td> <td>1.000</td> <td>PC</td> </tr> <tr> <td>SL1045A0</td> <td>S57 BLACK SILICONE - 80ml CARTRIDGE</td> <td>1.000</td> <td>PC</td> </tr> <tr> <td>VI1220A1</td> <td>4,2x12 TCB SELF-TAPPING SCREW</td> <td>2.000</td> <td>PC</td> </tr> </tbody> </table>	Code	Description	Qty	UOM	GN1327A0	HEATING ELEMENT GASKET	1.000	PC	RS1282B0		1.000	PC	SL1045A0	S57 BLACK SILICONE - 80ml CARTRIDGE	1.000	PC	VI1220A1	4,2x12 TCB SELF-TAPPING SCREW	2.000	PC
					Code	Description	Qty	UOM																	
					GN1327A0	HEATING ELEMENT GASKET	1.000	PC																	
					RS1282B0		1.000	PC																	
SL1045A0	S57 BLACK SILICONE - 80ml CARTRIDGE	1.000	PC																						
VI1220A1	4,2x12 TCB SELF-TAPPING SCREW	2.000	PC																						
GRL1005A	LineMiss Stefania RIGHT/LEFT LAT. GRID		KGRL1005A	R/L CHROM. PLATED LATERAL SUPP KIT	<table border="1"> <thead> <tr> <th>Code</th> <th>Description</th> <th>Qty</th> <th>UOM</th> </tr> </thead> <tbody> <tr> <td>GRL1005A2</td> <td>LineMiss Stefania RIGHT/LEFT LAT. GRID</td> <td>2.000</td> <td>PC</td> </tr> </tbody> </table>	Code	Description	Qty	UOM	GRL1005A2	LineMiss Stefania RIGHT/LEFT LAT. GRID	2.000	PC												
					Code	Description	Qty	UOM																	
GRL1005A2	LineMiss Stefania RIGHT/LEFT LAT. GRID	2.000	PC																						
VM1815A	LATERAL SUPPORTS FIXING BOLT		KVM1815A	MISS/MICRO/S4/S3 THUMB SCREW 10 PCS KIT	<table border="1"> <thead> <tr> <th>Code</th> <th>Description</th> <th>Qty</th> <th>UOM</th> </tr> </thead> <tbody> <tr> <td>VM1815A0</td> <td>LATERAL SUPPORTS FIXING BOLT</td> <td>10.000</td> <td>PC</td> </tr> </tbody> </table>	Code	Description	Qty	UOM	VM1815A0	LATERAL SUPPORTS FIXING BOLT	10.000	PC												
					Code	Description	Qty	UOM																	
VM1815A0	LATERAL SUPPORTS FIXING BOLT	10.000	PC																						
GN1596A	GN1110A - SHOP.PRO STEFANIA DOOR GASKET		KGN1596A	BL SHOP.PRO STEFANIA DOOR GASKET KIT	<table border="1"> <thead> <tr> <th>Code</th> <th>Description</th> <th>Qty</th> <th>UOM</th> </tr> </thead> <tbody> <tr> <td>GN1110A2</td> <td>Line Miss/XVC105-0 55/XK/XL DOOR GASKE</td> <td>1.500</td> <td>M</td> </tr> </tbody> </table>	Code	Description	Qty	UOM	GN1110A2	Line Miss/XVC105-0 55/XK/XL DOOR GASKE	1.500	M												
					Code	Description	Qty	UOM																	
GN1110A2	Line Miss/XVC105-0 55/XK/XL DOOR GASKE	1.500	M																						
RC1170A	M14 H=7 CH=22 STAINLESS STEEL NUT		KRC1170A	M14 H8 CH22 NUT - 10 PCS. KIT	<table border="1"> <thead> <tr> <th>Code</th> <th>Description</th> <th>Qty</th> <th>UOM</th> </tr> </thead> <tbody> <tr> <td>RC1170A1</td> <td>M14 H=7 CH=22 STAINLESS STEEL NUT</td> <td>10.000</td> <td>PC</td> </tr> </tbody> </table>	Code	Description	Qty	UOM	RC1170A1	M14 H=7 CH=22 STAINLESS STEEL NUT	10.000	PC												
					Code	Description	Qty	UOM																	
RC1170A1	M14 H=7 CH=22 STAINLESS STEEL NUT	10.000	PC																						



COMPONENT			SPARE PART		
Code	Description	Image	Code	Description	Kit components
TB1568A	ARI-STE-ROS SP WELDED EXT HUMIDITY PIPE		TB1568A0	ARI-STE-ROS SP WELDED EXT HUMIDITY PIPE	
TB1574A	FUME CHIMNEY D30 SHOP PRO		TB1574A0	FUME CHIMNEY D30 SHOP PRO	
TB1577B	STEFANIA SP INTERNAL HUMIDITY PIPE		TB1577B0	STEFANIA SP INTERNAL HUMIDITY PIPE	



ASM3407A/0.D01 - External cover

FRONT

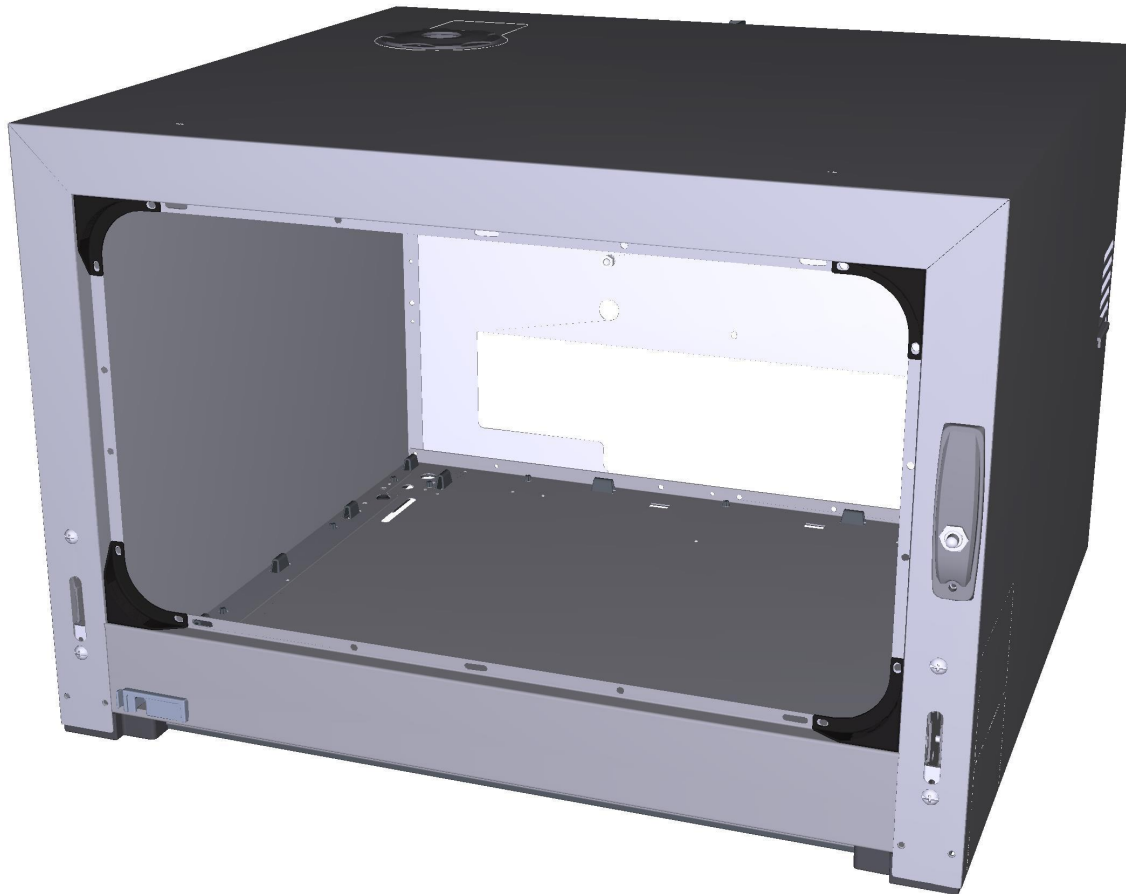





ASM3407A/0.D01 - External cover

REAR



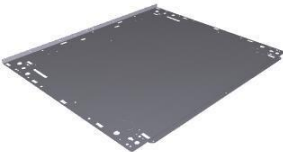





COMPONENT			SPARE PART														
Code	Description	Image	Code	Description	Kit components												
0D2401B	0D2401B0		0D2401B1	STEFANIA SP DROP-DOWN EXTERNAL CASING													
0D2409A	SP600 INF FRONT PROFILE DROP DOWN DOOR		0D2409A0	SP600 INF FRONT PROFILE DROP DOWN DOOR													
0E1381A	SP600 EXTERNAL BOTTOM PANEL		0E1381A1	STEFANIA SP DROP-DOWN EXTERNAL CASING													
0F1541B	STEFANIA SP BACK PANEL		0F1541B0	STEFANIA SP BACK PANEL													
CR1000A	HINGE LATCH L.M.		KCR1000A	LM HINGES LATCH KIT	<table border="1"> <thead> <tr> <th>Code</th> <th>Description</th> <th>Qty</th> <th>UOM</th> </tr> </thead> <tbody> <tr> <td>CR1000A0</td> <td>HINGE LATCH L.M.</td> <td>1.000</td> <td>PC</td> </tr> <tr> <td>VI1280A3</td> <td>M5x10 TC1/2T SCREW</td> <td>2.000</td> <td>PC</td> </tr> </tbody> </table>	Code	Description	Qty	UOM	CR1000A0	HINGE LATCH L.M.	1.000	PC	VI1280A3	M5x10 TC1/2T SCREW	2.000	PC
Code	Description	Qty	UOM														
CR1000A0	HINGE LATCH L.M.	1.000	PC														
VI1280A3	M5x10 TC1/2T SCREW	2.000	PC														



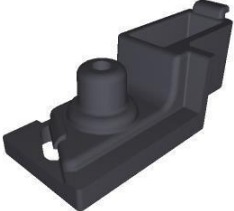

COMPONENT			SPARE PART														
Code	Description	Image	Code	Description	Kit components												
VM1750A	BRASS COMB CLAM		KVM1750A	COMB TERMINAL BLOCK KIT	<table border="1"> <thead> <tr> <th>Code</th> <th>Description</th> <th>Qty</th> <th>UOM</th> </tr> </thead> <tbody> <tr> <td>V11040A0</td> <td>INDENTED INTERNAL WASHER D=6 ZN</td> <td>2.000</td> <td>PC</td> </tr> <tr> <td>VM1750A0</td> <td>BRASS COMB CLAMP</td> <td>1.000</td> <td>PC</td> </tr> </tbody> </table>	Code	Description	Qty	UOM	V11040A0	INDENTED INTERNAL WASHER D=6 ZN	2.000	PC	VM1750A0	BRASS COMB CLAMP	1.000	PC
Code	Description	Qty	UOM														
V11040A0	INDENTED INTERNAL WASHER D=6 ZN	2.000	PC														
VM1750A0	BRASS COMB CLAMP	1.000	PC														
VM2502A	BAKERLUX SHOP.PRO CHIMNEY RING		KVM2502A	BAKERLUX SHOP.PRO CHIMNEY RING KIT	<table border="1"> <thead> <tr> <th>Code</th> <th>Description</th> <th>Qty</th> <th>UOM</th> </tr> </thead> <tbody> <tr> <td>VM2502A0</td> <td>BAKERLUX SHOP.PRO CHIMNEY RIN</td> <td>1.000</td> <td>PC</td> </tr> </tbody> </table>	Code	Description	Qty	UOM	VM2502A0	BAKERLUX SHOP.PRO CHIMNEY RIN	1.000	PC				
Code	Description	Qty	UOM														
VM2502A0	BAKERLUX SHOP.PRO CHIMNEY RIN	1.000	PC														
VM2495A	SP COOLING FAN SUPPORT		KVM2495A	COOLING FAN SUPPORT KIT	<table border="1"> <thead> <tr> <th>Code</th> <th>Description</th> <th>Qty</th> <th>UOM</th> </tr> </thead> <tbody> <tr> <td>V11220A1</td> <td>4,2x12 TCB SELF-TAPPIN G SCREW</td> <td>2.000</td> <td>PC</td> </tr> <tr> <td>VM2495A0</td> <td>SP COOLING FAN SUPPORT</td> <td>1.000</td> <td>PC</td> </tr> </tbody> </table>	Code	Description	Qty	UOM	V11220A1	4,2x12 TCB SELF-TAPPIN G SCREW	2.000	PC	VM2495A0	SP COOLING FAN SUPPORT	1.000	PC
Code	Description	Qty	UOM														
V11220A1	4,2x12 TCB SELF-TAPPIN G SCREW	2.000	PC														
VM2495A0	SP COOLING FAN SUPPORT	1.000	PC														
VN1175A	230V 50/60Hz 120x120 COOLING DOWN FAN		KVN1175A	120x120 230V 50/60Hz COOLING FAN KIT	<table border="1"> <thead> <tr> <th>Code</th> <th>Description</th> <th>Qty</th> <th>UOM</th> </tr> </thead> <tbody> <tr> <td>VN1175A0</td> <td>230V 50/60Hz 120x120 COOLING DOWN FAN</td> <td>1.000</td> <td>PC</td> </tr> </tbody> </table>	Code	Description	Qty	UOM	VN1175A0	230V 50/60Hz 120x120 COOLING DOWN FAN	1.000	PC				
Code	Description	Qty	UOM														
VN1175A0	230V 50/60Hz 120x120 COOLING DOWN FAN	1.000	PC														
VE1295A	MK 16A 230V DOOR MICROSWITCH		KVE1295A	16A 230V DOOR MICROSWITCH KIT	<table border="1"> <thead> <tr> <th>Code</th> <th>Description</th> <th>Qty</th> <th>UOM</th> </tr> </thead> <tbody> <tr> <td>VE1295A0</td> <td>MK 16A 230V DOOR MICROSWITC</td> <td>1.000</td> <td>PC</td> </tr> </tbody> </table>	Code	Description	Qty	UOM	VE1295A0	MK 16A 230V DOOR MICROSWITC	1.000	PC				
Code	Description	Qty	UOM														
VE1295A0	MK 16A 230V DOOR MICROSWITC	1.000	PC														



COMPONENT			SPARE PART																		
Code	Description	Image	Code	Description	Kit components																
VM2508A	BAKERLUX SHOP.PRO DOOR SWITCH COVER		KVM2508A	BAKERLUX SHOP.PRO MICROSWITCH COVER KIT	<table border="1"> <thead> <tr> <th>Code</th> <th>Description</th> <th>Qty</th> <th>UOM</th> </tr> </thead> <tbody> <tr> <td>VM2508A0</td> <td>BAKERLUX SHOP.PRO DOOR SWITCH COVE</td> <td>1.000</td> <td>PC</td> </tr> </tbody> </table>	Code	Description	Qty	UOM	VM2508A0	BAKERLUX SHOP.PRO DOOR SWITCH COVE	1.000	PC								
Code	Description	Qty	UOM																		
VM2508A0	BAKERLUX SHOP.PRO DOOR SWITCH COVE	1.000	PC																		
VM2481A	FRONT EXTERNAL COVER LEFT CAP S		KVM2481A	BL SP LEFT EXT COVER FRONT PANEL CAP KIT	<table border="1"> <thead> <tr> <th>Code</th> <th>Description</th> <th>Qty</th> <th>UOM</th> </tr> </thead> <tbody> <tr> <td>VM2481A0</td> <td>FRONT EXTERNAL COVER LEFT CAP SP</td> <td>1.000</td> <td>PC</td> </tr> </tbody> </table>	Code	Description	Qty	UOM	VM2481A0	FRONT EXTERNAL COVER LEFT CAP SP	1.000	PC								
Code	Description	Qty	UOM																		
VM2481A0	FRONT EXTERNAL COVER LEFT CAP SP	1.000	PC																		
VM2480A	FRONT EXTERNAL COVER RIGHT CAP SP		KVM2480A	BL SP RIGHT EXT COVER FRONT PANEL CAP	<table border="1"> <thead> <tr> <th>Code</th> <th>Description</th> <th>Qty</th> <th>UOM</th> </tr> </thead> <tbody> <tr> <td>VM2480A0</td> <td>FRONT EXTERNAL COVER RIGHT CAP SP</td> <td>1.000</td> <td>PC</td> </tr> </tbody> </table>	Code	Description	Qty	UOM	VM2480A0	FRONT EXTERNAL COVER RIGHT CAP SP	1.000	PC								
Code	Description	Qty	UOM																		
VM2480A0	FRONT EXTERNAL COVER RIGHT CAP SP	1.000	PC																		
VM1631A	PLUS INNER GLASS PUSHING CAP		KVM1631A	CAP FOR INTERNAL GLASS 10 PCS KIT	<table border="1"> <thead> <tr> <th>Code</th> <th>Description</th> <th>Qty</th> <th>UOM</th> </tr> </thead> <tbody> <tr> <td>VM1631A0</td> <td>PLUS INNER GLASS PUSHING CAP</td> <td>10.000</td> <td>PC</td> </tr> </tbody> </table>	Code	Description	Qty	UOM	VM1631A0	PLUS INNER GLASS PUSHING CAP	10.000	PC								
Code	Description	Qty	UOM																		
VM1631A0	PLUS INNER GLASS PUSHING CAP	10.000	PC																		
VM2490A	460X330 SP EXT FRONT BOTTOM GASKET		KVM2490A	SP 460X330 EXT BOTTOM PANEL GASKET KIT	<table border="1"> <thead> <tr> <th>Code</th> <th>Description</th> <th>Qty</th> <th>UOM</th> </tr> </thead> <tbody> <tr> <td>VM1794A0</td> <td>250x4.8 PA66 BLACK CLAMP</td> <td>2.000</td> <td>PC</td> </tr> <tr> <td>VM2103A0</td> <td>CLAMP LOCK</td> <td>2.000</td> <td>PC</td> </tr> <tr> <td>VM2490A0</td> <td>460X330 SP EXT FRONT BOTTOM GASKET</td> <td>2.000</td> <td>PC</td> </tr> </tbody> </table>	Code	Description	Qty	UOM	VM1794A0	250x4.8 PA66 BLACK CLAMP	2.000	PC	VM2103A0	CLAMP LOCK	2.000	PC	VM2490A0	460X330 SP EXT FRONT BOTTOM GASKET	2.000	PC
Code	Description	Qty	UOM																		
VM1794A0	250x4.8 PA66 BLACK CLAMP	2.000	PC																		
VM2103A0	CLAMP LOCK	2.000	PC																		
VM2490A0	460X330 SP EXT FRONT BOTTOM GASKET	2.000	PC																		

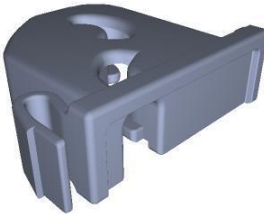

COMPONENT			SPARE PART																						
Code	Description	Image	Code	Description	Kit components																				
VM2491A	460X330 BL SP LATER BOTTOM PANEL GASKET		KVM2491A	SP 460X330 LAT BOTT PANEL GASKET 2PC KIT	<table border="1"> <thead> <tr> <th>Code</th> <th>Description</th> <th>Qty</th> <th>UOM</th> </tr> </thead> <tbody> <tr> <td>VM1631A0</td> <td>PLUS INNER GLASS PUSHING CAP</td> <td>4.000</td> <td>PC</td> </tr> <tr> <td>VM1794A0</td> <td>250x4.8 PA66 BLACK CLAMP</td> <td>2.000</td> <td>PC</td> </tr> <tr> <td>VM2103A0</td> <td>CLAMP LOCK</td> <td>2.000</td> <td>PC</td> </tr> <tr> <td>VM2491A1</td> <td>460x330 BLSP LATERAL BOTTOM PANEL GASKE</td> <td>2.000</td> <td>PC</td> </tr> </tbody> </table>	Code	Description	Qty	UOM	VM1631A0	PLUS INNER GLASS PUSHING CAP	4.000	PC	VM1794A0	250x4.8 PA66 BLACK CLAMP	2.000	PC	VM2103A0	CLAMP LOCK	2.000	PC	VM2491A1	460x330 BLSP LATERAL BOTTOM PANEL GASKE	2.000	PC
Code	Description	Qty	UOM																						
VM1631A0	PLUS INNER GLASS PUSHING CAP	4.000	PC																						
VM1794A0	250x4.8 PA66 BLACK CLAMP	2.000	PC																						
VM2103A0	CLAMP LOCK	2.000	PC																						
VM2491A1	460x330 BLSP LATERAL BOTTOM PANEL GASKE	2.000	PC																						
VM1222A	CABLE LOCKS SP ACCESSORIES EL CONNECTION		VM1222A0	CABLE LOCKS SP ACCESSORIES EL CONNECTION																					
VM2249A	COOKING CHAMBER FRONT CORNER		KVM2249A	CHAMBER FRONT PROFILE CORNER KIT	<table border="1"> <thead> <tr> <th>Code</th> <th>Description</th> <th>Qty</th> <th>UOM</th> </tr> </thead> <tbody> <tr> <td>VM2249A0</td> <td>COOKING CHAMBER FRONT CORNER</td> <td>1.000</td> <td>PC</td> </tr> </tbody> </table>	Code	Description	Qty	UOM	VM2249A0	COOKING CHAMBER FRONT CORNER	1.000	PC												
Code	Description	Qty	UOM																						
VM2249A0	COOKING CHAMBER FRONT CORNER	1.000	PC																						
VM2455A	BL SP CONTROL BOARD CABLE PASS-THROUGH		KVM2455A	BL SP CONTR BOARD CABLE PASS-THROUGH KIT	<table border="1"> <thead> <tr> <th>Code</th> <th>Description</th> <th>Qty</th> <th>UOM</th> </tr> </thead> <tbody> <tr> <td>VM2455A1</td> <td>SP CONTROL BOARD CABLE PASS-THROU GH CLIP</td> <td>1.000</td> <td>PC</td> </tr> </tbody> </table>	Code	Description	Qty	UOM	VM2455A1	SP CONTROL BOARD CABLE PASS-THROU GH CLIP	1.000	PC												
Code	Description	Qty	UOM																						
VM2455A1	SP CONTROL BOARD CABLE PASS-THROU GH CLIP	1.000	PC																						

ASM3419A/0.D00 - Door





FRONT



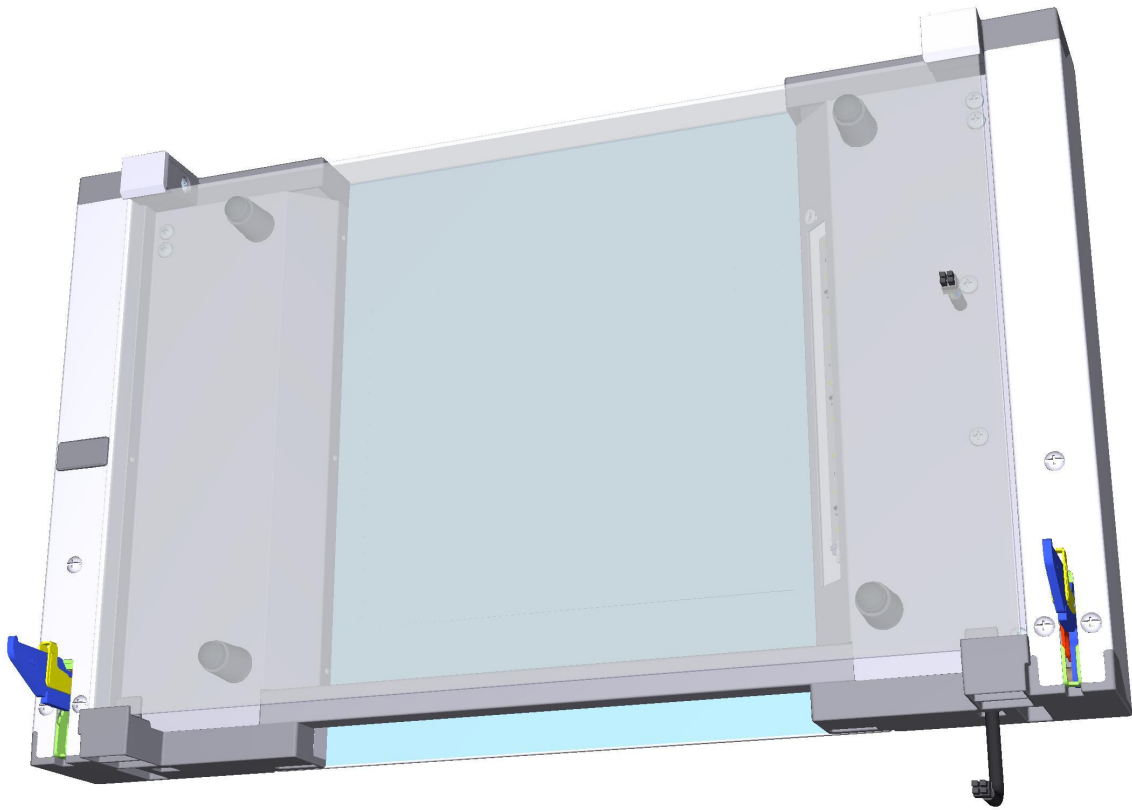

ASM3419A/0.D00 - Door

REAR





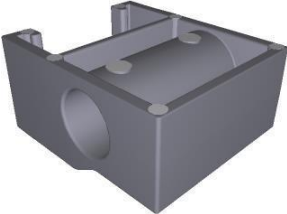

COMPONENT			SPARE PART																										
Code	Description	Image	Code	Description	Kit components																								
OB1286A	OB1286A0		OB1286A0	OB1286A0																									
OB1288A	OB1288A0		OB1288A0	OB1288A0																									
LP1050A	BL SHOP.PRO L180 COMPLETE LED BA		KLP1050A	L180 COMPLETE LED LIGHT BAR KIT	<table border="1"> <thead> <tr> <th>Code</th> <th>Description</th> <th>Qty</th> <th>UOM</th> </tr> </thead> <tbody> <tr> <td>LP1050A0</td> <td>BL SHOP.PRO L180 COMPLETE LED BAR</td> <td>1.000</td> <td>PC</td> </tr> <tr> <td>VI1014A0</td> <td>STAINLESS STEEL WASHER 4.5X9X0.8</td> <td>1.000</td> <td>PC</td> </tr> <tr> <td>VI1220A1</td> <td>4,2x12 TCB SELF-TAPPING SCREW</td> <td>1.000</td> <td>PC</td> </tr> </tbody> </table>	Code	Description	Qty	UOM	LP1050A0	BL SHOP.PRO L180 COMPLETE LED BAR	1.000	PC	VI1014A0	STAINLESS STEEL WASHER 4.5X9X0.8	1.000	PC	VI1220A1	4,2x12 TCB SELF-TAPPING SCREW	1.000	PC								
Code	Description	Qty	UOM																										
LP1050A0	BL SHOP.PRO L180 COMPLETE LED BAR	1.000	PC																										
VI1014A0	STAINLESS STEEL WASHER 4.5X9X0.8	1.000	PC																										
VI1220A1	4,2x12 TCB SELF-TAPPING SCREW	1.000	PC																										
TB3301A	TB3301A0		KTB3301A	BL SP 460X330 DROPDOWN HANDLE TUBE KIT	<table border="1"> <thead> <tr> <th>Code</th> <th>Description</th> <th>Qty</th> <th>UOM</th> </tr> </thead> <tbody> <tr> <td>TB3301A0</td> <td>TB3301A0</td> <td>1.000</td> <td>PC</td> </tr> <tr> <td>VI1147A0</td> <td>5X25 STAINLESS STEEL SCREW</td> <td>4.000</td> <td>PC</td> </tr> <tr> <td>VM2456A0</td> <td>BAKERLUX SHOP.PRO HANDLE END</td> <td>1.000</td> <td>PC</td> </tr> <tr> <td>VM2489A0</td> <td>SP HANDLE END KIT + STYLUS KIT</td> <td>1.000</td> <td>PC</td> </tr> <tr> <td>VM2527A0</td> <td>STYLUS PEN FOR SP</td> <td>1.000</td> <td>PC</td> </tr> </tbody> </table>	Code	Description	Qty	UOM	TB3301A0	TB3301A0	1.000	PC	VI1147A0	5X25 STAINLESS STEEL SCREW	4.000	PC	VM2456A0	BAKERLUX SHOP.PRO HANDLE END	1.000	PC	VM2489A0	SP HANDLE END KIT + STYLUS KIT	1.000	PC	VM2527A0	STYLUS PEN FOR SP	1.000	PC
Code	Description	Qty	UOM																										
TB3301A0	TB3301A0	1.000	PC																										
VI1147A0	5X25 STAINLESS STEEL SCREW	4.000	PC																										
VM2456A0	BAKERLUX SHOP.PRO HANDLE END	1.000	PC																										
VM2489A0	SP HANDLE END KIT + STYLUS KIT	1.000	PC																										
VM2527A0	STYLUS PEN FOR SP	1.000	PC																										

COMPONENT			SPARE PART																						
Code	Description	Image	Code	Description	Kit components																				
VM2456A	BAKERLUX SHOP.PRO HANDLE END		KVM2456A	2 PCS BAKERLUX SHOP.PRO HANDLE END KIT	<table border="1"> <thead> <tr> <th>Code</th> <th>Description</th> <th>Qty</th> <th>UOM</th> </tr> </thead> <tbody> <tr> <td>VI1147A0</td> <td>5X25 STAINLESS STEEL SCREW</td> <td>4.000</td> <td>PC</td> </tr> <tr> <td>VM2456A0</td> <td>BAKERLUX SHOP.PRO HANDLE END</td> <td>1.000</td> <td>PC</td> </tr> <tr> <td>VM2489A0</td> <td>SP HANDLE END KIT + STYLUS KIT</td> <td>1.000</td> <td>PC</td> </tr> <tr> <td>VM2527A0</td> <td>STYLUS PEN FOR SP</td> <td>1.000</td> <td>PC</td> </tr> </tbody> </table>	Code	Description	Qty	UOM	VI1147A0	5X25 STAINLESS STEEL SCREW	4.000	PC	VM2456A0	BAKERLUX SHOP.PRO HANDLE END	1.000	PC	VM2489A0	SP HANDLE END KIT + STYLUS KIT	1.000	PC	VM2527A0	STYLUS PEN FOR SP	1.000	PC
Code	Description	Qty	UOM																						
VI1147A0	5X25 STAINLESS STEEL SCREW	4.000	PC																						
VM2456A0	BAKERLUX SHOP.PRO HANDLE END	1.000	PC																						
VM2489A0	SP HANDLE END KIT + STYLUS KIT	1.000	PC																						
VM2527A0	STYLUS PEN FOR SP	1.000	PC																						
VM2527A	STYLUS PEN FOR S		KVM2527A	EVEREO-BLSP TOUCH STYLUS 5 PCS KIT	<table border="1"> <thead> <tr> <th>Code</th> <th>Description</th> <th>Qty</th> <th>UOM</th> </tr> </thead> <tbody> <tr> <td>VM2527A0</td> <td>STYLUS PEN FOR SP</td> <td>5.000</td> <td>PC</td> </tr> </tbody> </table>	Code	Description	Qty	UOM	VM2527A0	STYLUS PEN FOR SP	5.000	PC												
Code	Description	Qty	UOM																						
VM2527A0	STYLUS PEN FOR SP	5.000	PC																						
VM2471A	BL SP LOWER CLAMP INT LOCK GLASS SLIDER		KVM2471A	BL SP INTERNAL GLASS LOCK HOLDER KIT	<table border="1"> <thead> <tr> <th>Code</th> <th>Description</th> <th>Qty</th> <th>UOM</th> </tr> </thead> <tbody> <tr> <td>VI1998A0</td> <td>ZINC PLATED SCREW 5X30 TCB</td> <td>2.000</td> <td>PC</td> </tr> <tr> <td>VM2471A0</td> <td>BL SP LOWER CLAMP INT LOCK GLASS SLIDER</td> <td>1.000</td> <td>PC</td> </tr> <tr> <td>VM2472A0</td> <td>BL SP UPPER CLAMP INT LOCK GLASS SLIDER</td> <td>1.000</td> <td>PC</td> </tr> </tbody> </table>	Code	Description	Qty	UOM	VI1998A0	ZINC PLATED SCREW 5X30 TCB	2.000	PC	VM2471A0	BL SP LOWER CLAMP INT LOCK GLASS SLIDER	1.000	PC	VM2472A0	BL SP UPPER CLAMP INT LOCK GLASS SLIDER	1.000	PC				
Code	Description	Qty	UOM																						
VI1998A0	ZINC PLATED SCREW 5X30 TCB	2.000	PC																						
VM2471A0	BL SP LOWER CLAMP INT LOCK GLASS SLIDER	1.000	PC																						
VM2472A0	BL SP UPPER CLAMP INT LOCK GLASS SLIDER	1.000	PC																						
VM2503A	SLIDE TO FIX INTERNAL NON REMOV GLASS SP		KVM2503A	BL SP INT FIXED GLASS LOCK 2 PCS KIT	<table border="1"> <thead> <tr> <th>Code</th> <th>Description</th> <th>Qty</th> <th>UOM</th> </tr> </thead> <tbody> <tr> <td>VM2503A0</td> <td>SLIDE TO FIX INTERNAL NON REMOV GLASS SP</td> <td>2.000</td> <td>PC</td> </tr> </tbody> </table>	Code	Description	Qty	UOM	VM2503A0	SLIDE TO FIX INTERNAL NON REMOV GLASS SP	2.000	PC												
Code	Description	Qty	UOM																						
VM2503A0	SLIDE TO FIX INTERNAL NON REMOV GLASS SP	2.000	PC																						

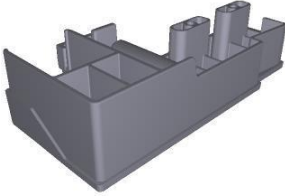
COMPONENT			SPARE PART																		
Code	Description	Image	Code	Description	Kit components																
VM2464A	SHOP.PRO LEFT UPPER CAP DROP DOWN DOOR		KVM2464A	BL SP LEFT UPPER DROPDOWN DOOR CAP KIT	<table border="1"> <thead> <tr> <th>Code</th> <th>Description</th> <th>Qty</th> <th>UOM</th> </tr> </thead> <tbody> <tr> <td>VM2464A0</td> <td>SHOP.PRO LEFT UPPER CAP DROP DOWN DOOR</td> <td>1.000</td> <td>PC</td> </tr> </tbody> </table>	Code	Description	Qty	UOM	VM2464A0	SHOP.PRO LEFT UPPER CAP DROP DOWN DOOR	1.000	PC								
Code	Description	Qty	UOM																		
VM2464A0	SHOP.PRO LEFT UPPER CAP DROP DOWN DOOR	1.000	PC																		
VM2472A	BL SP UPPER CLAMP INT LOCK GLASS SLIDER		KVM2471A	BL SP INTERNAL GLASS LOCK HOLDER KIT	<table border="1"> <thead> <tr> <th>Code</th> <th>Description</th> <th>Qty</th> <th>UOM</th> </tr> </thead> <tbody> <tr> <td>V11998A0</td> <td>ZINC PLATED SCREW 5X30 TCB</td> <td>2.000</td> <td>PC</td> </tr> <tr> <td>VM2471A0</td> <td>BL SP LOWER CLAMP INT LOCK GLASS SLIDER</td> <td>1.000</td> <td>PC</td> </tr> <tr> <td>VM2472A0</td> <td>BL SP UPPER CLAMP INT LOCK GLASS SLIDER</td> <td>1.000</td> <td>PC</td> </tr> </tbody> </table>	Code	Description	Qty	UOM	V11998A0	ZINC PLATED SCREW 5X30 TCB	2.000	PC	VM2471A0	BL SP LOWER CLAMP INT LOCK GLASS SLIDER	1.000	PC	VM2472A0	BL SP UPPER CLAMP INT LOCK GLASS SLIDER	1.000	PC
Code	Description	Qty	UOM																		
V11998A0	ZINC PLATED SCREW 5X30 TCB	2.000	PC																		
VM2471A0	BL SP LOWER CLAMP INT LOCK GLASS SLIDER	1.000	PC																		
VM2472A0	BL SP UPPER CLAMP INT LOCK GLASS SLIDER	1.000	PC																		
VM2503A	SLIDE TO FIX INTERNAL NON REMOV GLASS SP		KVM2503A	BL SP INT FIXED GLASS LOCK 2 PCS KIT	<table border="1"> <thead> <tr> <th>Code</th> <th>Description</th> <th>Qty</th> <th>UOM</th> </tr> </thead> <tbody> <tr> <td>VM2503A0</td> <td>SLIDE TO FIX INTERNAL NON REMOV GLASS SP</td> <td>2.000</td> <td>PC</td> </tr> </tbody> </table>	Code	Description	Qty	UOM	VM2503A0	SLIDE TO FIX INTERNAL NON REMOV GLASS SP	2.000	PC								
Code	Description	Qty	UOM																		
VM2503A0	SLIDE TO FIX INTERNAL NON REMOV GLASS SP	2.000	PC																		
VM2463A	SHOP.PRO RIGHT UPPER CAP DROP DOWN DOOR		KVM2463A	BL SP RIGHT UPPER DROPDOWN DOOR CAP KIT	<table border="1"> <thead> <tr> <th>Code</th> <th>Description</th> <th>Qty</th> <th>UOM</th> </tr> </thead> <tbody> <tr> <td>VM2463A0</td> <td>SHOP.PRO RIGHT UPPER CAP DROP DOWN DOOR</td> <td>1.000</td> <td>PC</td> </tr> </tbody> </table>	Code	Description	Qty	UOM	VM2463A0	SHOP.PRO RIGHT UPPER CAP DROP DOWN DOOR	1.000	PC								
Code	Description	Qty	UOM																		
VM2463A0	SHOP.PRO RIGHT UPPER CAP DROP DOWN DOOR	1.000	PC																		
VM2461A	BL SP RIGHT LOWER DROPDOWN DOOR CAP KIT		KVM2461A	BL SP RIGHT LOWER DROPDOWN DOOR CAP KIT	<table border="1"> <thead> <tr> <th>Code</th> <th>Description</th> <th>Qty</th> <th>UOM</th> </tr> </thead> <tbody> <tr> <td>VM2461A0</td> <td>BL SP RIGHT LOWER DROPDOWN DOOR CAP KIT</td> <td>1.000</td> <td>PC</td> </tr> </tbody> </table>	Code	Description	Qty	UOM	VM2461A0	BL SP RIGHT LOWER DROPDOWN DOOR CAP KIT	1.000	PC								
Code	Description	Qty	UOM																		
VM2461A0	BL SP RIGHT LOWER DROPDOWN DOOR CAP KIT	1.000	PC																		

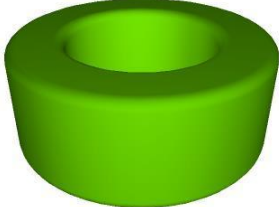

COMPONENT			SPARE PART														
Code	Description	Image	Code	Description	Kit components												
VM2462A	BL SP LEFT LOWER DROPDOWN DOOR CAP		KVM2462A	BL SP LEFT LOWER DROPDOWN DOOR CAP KIT	<table border="1"> <thead> <tr> <th>Code</th> <th>Description</th> <th>Qty</th> <th>UOM</th> </tr> </thead> <tbody> <tr> <td>VM2462A0</td> <td>BL SP LEFT LOWER DROPDOWN DOOR CAP</td> <td>1.000</td> <td>PC</td> </tr> </tbody> </table>	Code	Description	Qty	UOM	VM2462A0	BL SP LEFT LOWER DROPDOWN DOOR CAP	1.000	PC				
Code	Description	Qty	UOM														
VM2462A0	BL SP LEFT LOWER DROPDOWN DOOR CAP	1.000	PC														
VM1630A	INTERNAL GLASS PUSHING CAP		KVM1630A	CAP FOR INTERNAL GLASS 10 PCS KIT	<table border="1"> <thead> <tr> <th>Code</th> <th>Description</th> <th>Qty</th> <th>UOM</th> </tr> </thead> <tbody> <tr> <td>VM1630A1</td> <td>INTERNAL GLASS PUSHING CAP</td> <td>10.000</td> <td>PC</td> </tr> </tbody> </table>	Code	Description	Qty	UOM	VM1630A1	INTERNAL GLASS PUSHING CAP	10.000	PC				
Code	Description	Qty	UOM														
VM1630A1	INTERNAL GLASS PUSHING CAP	10.000	PC														
VM2478A	BL SP GLASS H4 PUSHING BRACKET		KVM2478A	BL SHOP.PRO H4 GLASS SUPPORT 4 PCS KIT	<table border="1"> <thead> <tr> <th>Code</th> <th>Description</th> <th>Qty</th> <th>UOM</th> </tr> </thead> <tbody> <tr> <td>VM1630A1</td> <td>INTERNAL GLASS PUSHING CAP</td> <td>4.000</td> <td>PC</td> </tr> <tr> <td>VM2478A0</td> <td>BL SP GLASS H4 PUSHING BRACKET</td> <td>4.000</td> <td>PC</td> </tr> </tbody> </table>	Code	Description	Qty	UOM	VM1630A1	INTERNAL GLASS PUSHING CAP	4.000	PC	VM2478A0	BL SP GLASS H4 PUSHING BRACKET	4.000	PC
Code	Description	Qty	UOM														
VM1630A1	INTERNAL GLASS PUSHING CAP	4.000	PC														
VM2478A0	BL SP GLASS H4 PUSHING BRACKET	4.000	PC														
CE1095A	4 POLES MICROFIT 2 M BUS CABLE		KCE1095A	4POLES 2M BUS CABLE KIT POWER-CONTROL	<table border="1"> <thead> <tr> <th>Code</th> <th>Description</th> <th>Qty</th> <th>UOM</th> </tr> </thead> <tbody> <tr> <td>CE1095A0</td> <td>4 POLES MICROFIT 2 M BUS CABLE</td> <td>1.000</td> <td>PC</td> </tr> </tbody> </table>	Code	Description	Qty	UOM	CE1095A0	4 POLES MICROFIT 2 M BUS CABLE	1.000	PC				
Code	Description	Qty	UOM														
CE1095A0	4 POLES MICROFIT 2 M BUS CABLE	1.000	PC														
CE1285A	EMI ROUND FERRITE MOD.2643801502		KCE1285A	ROUND FERRITE ELECTROMAGN PROT. 2PCS KIT	<table border="1"> <thead> <tr> <th>Code</th> <th>Description</th> <th>Qty</th> <th>UOM</th> </tr> </thead> <tbody> <tr> <td>CE1285A0</td> <td>EMI ROUND FERRITE MOD.2643801502</td> <td>2.000</td> <td>PC</td> </tr> </tbody> </table>	Code	Description	Qty	UOM	CE1285A0	EMI ROUND FERRITE MOD.2643801502	2.000	PC				
Code	Description	Qty	UOM														
CE1285A0	EMI ROUND FERRITE MOD.2643801502	2.000	PC														



COMPONENT			SPARE PART																																																																										
Code	Description	Image	Code	Description	Kit components																																																																								
VT1323A	SP STEFANIA 357x364x4 EXTERNAL GLASS		KDR1285A	BL SHOP.PRO STEFANIA EXTER DOOR KIT LEFT	<table border="1"> <thead> <tr> <th>Code</th> <th>Description</th> <th>Qty</th> <th>UOM</th> </tr> </thead> <tbody> <tr> <td>0B1295B0</td> <td>SP STE-ELE RIGHT DOOR RIGHT EXT COLUMN</td> <td>1.000</td> <td>PC</td> </tr> <tr> <td>0B1296B0</td> <td>SP STE-ELE RIGHT DOOR RIGHT INT COLUMN</td> <td>1.000</td> <td>PC</td> </tr> <tr> <td>CR1040A0</td> <td>DOOR LATCH FOR EL.MECH. LOCKING SYSTEM</td> <td>1.000</td> <td>PC</td> </tr> <tr> <td>ML1005A0</td> <td>DES DF0.6 H18 COMPRESSIO N SPRING</td> <td>2.000</td> <td>PC</td> </tr> <tr> <td>SL1185A0</td> <td></td> <td>2.000</td> <td>PC</td> </tr> <tr> <td>TB1562A0</td> <td>DOOR LATERAL BEAM SP600</td> <td>2.000</td> <td>PC</td> </tr> <tr> <td>TB3303A0</td> <td>SHOP.PRO STE-ELE FLAG DOOR HANDLE TUBE</td> <td>1.000</td> <td>PC</td> </tr> <tr> <td>VI1036A0</td> <td>ST STEEL STRIPED THREAD M10 FTT/C INSERT</td> <td>1.000</td> <td>PC</td> </tr> <tr> <td>VI1147A0</td> <td>5X25 STAINLESS STEEL SCREW</td> <td>20.000</td> <td>PC</td> </tr> <tr> <td>VI1220A1</td> <td>4,2x12 TCB SELF-TAPPIN G SCREW</td> <td>12.000</td> <td>PC</td> </tr> <tr> <td>VI1998A0</td> <td>ZINC PLATED SCREW 5X30 TCB</td> <td>2.000</td> <td>PC</td> </tr> <tr> <td>VM1209A0</td> <td>SHOP.PRO LOCK PIN WASHER</td> <td>1.000</td> <td>PC</td> </tr> <tr> <td>VM1630A1</td> <td>INTERNAL GLASS PUSHING CAP</td> <td>4.000</td> <td>PC</td> </tr> <tr> <td>VM2274A0</td> <td>GROOVED BUSHING</td> <td>1.000</td> <td>PC</td> </tr> <tr> <td>VM2275A0</td> <td>SMOOTH BUSHING</td> <td>1.000</td> <td>PC</td> </tr> <tr> <td>VM2456A0</td> <td>BAKERLUX SHOP.PRO HANDLE END</td> <td>1.000</td> <td>PC</td> </tr> <tr> <td>VM2465A0</td> <td>SP SIDE-OPENIN G DOOR RIGHT LOWER CAP KIT</td> <td>1.000</td> <td>PC</td> </tr> </tbody> </table>	Code	Description	Qty	UOM	0B1295B0	SP STE-ELE RIGHT DOOR RIGHT EXT COLUMN	1.000	PC	0B1296B0	SP STE-ELE RIGHT DOOR RIGHT INT COLUMN	1.000	PC	CR1040A0	DOOR LATCH FOR EL.MECH. LOCKING SYSTEM	1.000	PC	ML1005A0	DES DF0.6 H18 COMPRESSIO N SPRING	2.000	PC	SL1185A0		2.000	PC	TB1562A0	DOOR LATERAL BEAM SP600	2.000	PC	TB3303A0	SHOP.PRO STE-ELE FLAG DOOR HANDLE TUBE	1.000	PC	VI1036A0	ST STEEL STRIPED THREAD M10 FTT/C INSERT	1.000	PC	VI1147A0	5X25 STAINLESS STEEL SCREW	20.000	PC	VI1220A1	4,2x12 TCB SELF-TAPPIN G SCREW	12.000	PC	VI1998A0	ZINC PLATED SCREW 5X30 TCB	2.000	PC	VM1209A0	SHOP.PRO LOCK PIN WASHER	1.000	PC	VM1630A1	INTERNAL GLASS PUSHING CAP	4.000	PC	VM2274A0	GROOVED BUSHING	1.000	PC	VM2275A0	SMOOTH BUSHING	1.000	PC	VM2456A0	BAKERLUX SHOP.PRO HANDLE END	1.000	PC	VM2465A0	SP SIDE-OPENIN G DOOR RIGHT LOWER CAP KIT	1.000	PC
Code	Description	Qty	UOM																																																																										
0B1295B0	SP STE-ELE RIGHT DOOR RIGHT EXT COLUMN	1.000	PC																																																																										
0B1296B0	SP STE-ELE RIGHT DOOR RIGHT INT COLUMN	1.000	PC																																																																										
CR1040A0	DOOR LATCH FOR EL.MECH. LOCKING SYSTEM	1.000	PC																																																																										
ML1005A0	DES DF0.6 H18 COMPRESSIO N SPRING	2.000	PC																																																																										
SL1185A0		2.000	PC																																																																										
TB1562A0	DOOR LATERAL BEAM SP600	2.000	PC																																																																										
TB3303A0	SHOP.PRO STE-ELE FLAG DOOR HANDLE TUBE	1.000	PC																																																																										
VI1036A0	ST STEEL STRIPED THREAD M10 FTT/C INSERT	1.000	PC																																																																										
VI1147A0	5X25 STAINLESS STEEL SCREW	20.000	PC																																																																										
VI1220A1	4,2x12 TCB SELF-TAPPIN G SCREW	12.000	PC																																																																										
VI1998A0	ZINC PLATED SCREW 5X30 TCB	2.000	PC																																																																										
VM1209A0	SHOP.PRO LOCK PIN WASHER	1.000	PC																																																																										
VM1630A1	INTERNAL GLASS PUSHING CAP	4.000	PC																																																																										
VM2274A0	GROOVED BUSHING	1.000	PC																																																																										
VM2275A0	SMOOTH BUSHING	1.000	PC																																																																										
VM2456A0	BAKERLUX SHOP.PRO HANDLE END	1.000	PC																																																																										
VM2465A0	SP SIDE-OPENIN G DOOR RIGHT LOWER CAP KIT	1.000	PC																																																																										



COMPONENT			SPARE PART																																																																					
Code	Description	Image	Code	Description	Kit components																																																																			
VT1323A	SP STEFANIA 357x364x4 EXTERNAL GLASS		KDR1285A	BL SHOP.PRO STEFANIA EXTER DOOR KIT LEFT	<table border="1"> <thead> <tr> <th>Code</th> <th>Description</th> <th>Qty</th> <th>UOM</th> </tr> </thead> <tbody> <tr> <td>VM2466A0</td> <td>BL SP LEFT LOWER LATERAL DOOR CAP</td> <td>1.000</td> <td>PC</td> </tr> <tr> <td>VM2467A0</td> <td>SP SIDE-OPENIN G DOOR RIGHT UPPER CAP KIT</td> <td>1.000</td> <td>PC</td> </tr> <tr> <td>VM2468A0</td> <td>BL SP LEFT UPPER LATERAL DOOR CAP</td> <td>1.000</td> <td>PC</td> </tr> <tr> <td>VM2470A0</td> <td>SLIDE TO FIX INTERNAL GLASS SHOP.PRO</td> <td>2.000</td> <td>PC</td> </tr> <tr> <td>VM2471A0</td> <td>BL SP LOWER CLAMP INT LOCK GLASS SLIDER</td> <td>1.000</td> <td>PC</td> </tr> <tr> <td>VM2472A0</td> <td>BL SP UPPER CLAMP INT LOCK GLASS SLIDER</td> <td>1.000</td> <td>PC</td> </tr> <tr> <td>VM2473A0</td> <td>BL SP INT GLASS HINGE LOWER LOCK PIN</td> <td>1.000</td> <td>PC</td> </tr> <tr> <td>VM2474A0</td> <td>BL SP INT GLASS HINGE UPPER LOCK PIN</td> <td>1.000</td> <td>PC</td> </tr> <tr> <td>VM2478A0</td> <td>BL SP GLASS H4 PUSHING BRACKET</td> <td>4.000</td> <td>PC</td> </tr> <tr> <td>VM2489A0</td> <td>SP HANDLE END KIT + STYLUS KIT</td> <td>1.000</td> <td>PC</td> </tr> <tr> <td>VM2504A0</td> <td>DOWEL TO GUIDE SLIDE SPRING SHOP.PRO</td> <td>2.000</td> <td>PC</td> </tr> <tr> <td>VM2527A0</td> <td>STYLUS PEN FOR SP</td> <td>1.000</td> <td>PC</td> </tr> <tr> <td>VT1323A0</td> <td>SP STEFANIA 357x364x4 EXTERNAL GLASS</td> <td>1.000</td> <td>PC</td> </tr> </tbody> </table>	Code	Description	Qty	UOM	VM2466A0	BL SP LEFT LOWER LATERAL DOOR CAP	1.000	PC	VM2467A0	SP SIDE-OPENIN G DOOR RIGHT UPPER CAP KIT	1.000	PC	VM2468A0	BL SP LEFT UPPER LATERAL DOOR CAP	1.000	PC	VM2470A0	SLIDE TO FIX INTERNAL GLASS SHOP.PRO	2.000	PC	VM2471A0	BL SP LOWER CLAMP INT LOCK GLASS SLIDER	1.000	PC	VM2472A0	BL SP UPPER CLAMP INT LOCK GLASS SLIDER	1.000	PC	VM2473A0	BL SP INT GLASS HINGE LOWER LOCK PIN	1.000	PC	VM2474A0	BL SP INT GLASS HINGE UPPER LOCK PIN	1.000	PC	VM2478A0	BL SP GLASS H4 PUSHING BRACKET	4.000	PC	VM2489A0	SP HANDLE END KIT + STYLUS KIT	1.000	PC	VM2504A0	DOWEL TO GUIDE SLIDE SPRING SHOP.PRO	2.000	PC	VM2527A0	STYLUS PEN FOR SP	1.000	PC	VT1323A0	SP STEFANIA 357x364x4 EXTERNAL GLASS	1.000	PC	KDR1284A	BL SHOP.PRO STEFANIA EXTERNAL DOOR KI	<table border="1"> <thead> <tr> <th>Code</th> <th>Description</th> <th>Qty</th> <th>UOM</th> </tr> </thead> <tbody> <tr> <td>0B1293A0</td> <td>SP STE-ELE RIGHT DOOR LEFT EXT COLUMN</td> <td>1.000</td> <td>PC</td> </tr> </tbody> </table>	Code	Description	Qty	UOM	0B1293A0	SP STE-ELE RIGHT DOOR LEFT EXT COLUMN	1.000	PC
			Code	Description	Qty	UOM																																																																		
VM2466A0	BL SP LEFT LOWER LATERAL DOOR CAP	1.000	PC																																																																					
VM2467A0	SP SIDE-OPENIN G DOOR RIGHT UPPER CAP KIT	1.000	PC																																																																					
VM2468A0	BL SP LEFT UPPER LATERAL DOOR CAP	1.000	PC																																																																					
VM2470A0	SLIDE TO FIX INTERNAL GLASS SHOP.PRO	2.000	PC																																																																					
VM2471A0	BL SP LOWER CLAMP INT LOCK GLASS SLIDER	1.000	PC																																																																					
VM2472A0	BL SP UPPER CLAMP INT LOCK GLASS SLIDER	1.000	PC																																																																					
VM2473A0	BL SP INT GLASS HINGE LOWER LOCK PIN	1.000	PC																																																																					
VM2474A0	BL SP INT GLASS HINGE UPPER LOCK PIN	1.000	PC																																																																					
VM2478A0	BL SP GLASS H4 PUSHING BRACKET	4.000	PC																																																																					
VM2489A0	SP HANDLE END KIT + STYLUS KIT	1.000	PC																																																																					
VM2504A0	DOWEL TO GUIDE SLIDE SPRING SHOP.PRO	2.000	PC																																																																					
VM2527A0	STYLUS PEN FOR SP	1.000	PC																																																																					
VT1323A0	SP STEFANIA 357x364x4 EXTERNAL GLASS	1.000	PC																																																																					
Code	Description	Qty	UOM																																																																					
0B1293A0	SP STE-ELE RIGHT DOOR LEFT EXT COLUMN	1.000	PC																																																																					



COMPONENT			SPARE PART			
Code	Description	Image	Code	Description	Kit components	
VT1323A	SP STEFANIA 357x364x4 EXTERNAL GLASS		KDR1284A	BL SHOP.PRO STEFANIA EXTERNAL DOOR KI	Code	Description Qty UOM
					0B1294A0	SP STE-ELE 1.000 PC RIGHT DOOR LEFT INT COLUMN
					0B1295B0	SP STE-ELE 1.000 PC RIGHT DOOR RIGHT EXT COLUMN
					0B1296B0	SP STE-ELE 1.000 PC RIGHT DOOR RIGHT INT COLUMN
					CR1040A0	DOOR LATCH 1.000 PC FOR EL.MECH. LOCKING SYSTEM
					ML1005A0	DE5 DF0.6 H18 2.000 PC COMPRESSIO N SPRING
					SL1185A0	2.000 PC
					TB1562A0	DOOR 2.000 PC LATERAL BEAM SP600
					TB3303A0	SHOP.PRO 1.000 PC STE-ELE FLAG DOOR HANDLE TUBE
					VI1036A0	ST STEEL 1.000 PC STRIPED THREAD M10 FTT/C INSERT
					VI1147A0	5X25 20.000 PC STAINLESS STEEL SCREW
					VI1220A1	4,2x12 TCB 12.000 PC SELF-TAPPIN G SCREW
					VI1998A0	ZINC PLATED 2.000 PC SCREW 5X30 TCB
					VM1209A0	SHOP.PRO 1.000 PC LOCK PIN WASHER
					VM1630A1	INTERNAL 4.000 PC GLASS PUSHING CAP
					VM2274A0	GROOVED 1.000 PC BUSHING
					VM2275A0	SMOOTH 1.000 PC BUSHING
					VM2456A0	BAKERLUX 1.000 PC SHOP.PRO HANDLE END





COMPONENT			SPARE PART																																																																
Code	Description	Image	Code	Description	Kit components																																																														
VT1323A	SP STEFANIA 357x364x4 EXTERNAL GLASS		KDR1284A	BL SHOP.PRO STEFANIA EXTERNAL DOOR KI	<table border="1"> <thead> <tr> <th>Code</th> <th>Description</th> <th>Qty</th> <th>UOM</th> </tr> </thead> <tbody> <tr> <td>VM2465A0</td> <td>SP SIDE-OPENIN G DOOR RIGHT LOWER CAP KIT</td> <td>1.000</td> <td>PC</td> </tr> <tr> <td>VM2466A0</td> <td>BL SP LEFT LOWER LATERAL DOOR CAP</td> <td>1.000</td> <td>PC</td> </tr> <tr> <td>VM2467A0</td> <td>SP SIDE-OPENIN G DOOR RIGHT UPPER CAP KIT</td> <td>1.000</td> <td>PC</td> </tr> <tr> <td>VM2468A0</td> <td>BL SP LEFT UPPER LATERAL DOOR CAP</td> <td>1.000</td> <td>PC</td> </tr> <tr> <td>VM2470A0</td> <td>SLIDE TO FIX INTERNAL GLASS SHOP.PRO</td> <td>2.000</td> <td>PC</td> </tr> <tr> <td>VM2471A0</td> <td>BL SP LOWER CLAMP INT LOCK GLASS SLIDER</td> <td>1.000</td> <td>PC</td> </tr> <tr> <td>VM2472A0</td> <td>BL SP UPPER CLAMP INT LOCK GLASS SLIDER</td> <td>1.000</td> <td>PC</td> </tr> <tr> <td>VM2473A0</td> <td>BL SP INT GLASS HINGE LOWER LOCK PIN</td> <td>1.000</td> <td>PC</td> </tr> <tr> <td>VM2474A0</td> <td>BL SP INT GLASS HINGE UPPER LOCK PIN</td> <td>1.000</td> <td>PC</td> </tr> <tr> <td>VM2478A0</td> <td>BL SP GLASS H4 PUSHING BRACKET</td> <td>4.000</td> <td>PC</td> </tr> <tr> <td>VM2489A0</td> <td>SP HANDLE END KIT + STYLUS KIT</td> <td>1.000</td> <td>PC</td> </tr> <tr> <td>VM2504A0</td> <td>DOWEL TO GUIDE SLIDE SPRING SHOP.PRO</td> <td>2.000</td> <td>PC</td> </tr> <tr> <td>VM2527A0</td> <td>STYLUS PEN FOR SP</td> <td>1.000</td> <td>PC</td> </tr> <tr> <td>VT1323A0</td> <td>SP STEFANIA 357x364x4 EXTERNAL GLASS</td> <td></td> <td></td> <td></td> <td>1.000 PC</td> </tr> </tbody> </table>	Code	Description	Qty	UOM	VM2465A0	SP SIDE-OPENIN G DOOR RIGHT LOWER CAP KIT	1.000	PC	VM2466A0	BL SP LEFT LOWER LATERAL DOOR CAP	1.000	PC	VM2467A0	SP SIDE-OPENIN G DOOR RIGHT UPPER CAP KIT	1.000	PC	VM2468A0	BL SP LEFT UPPER LATERAL DOOR CAP	1.000	PC	VM2470A0	SLIDE TO FIX INTERNAL GLASS SHOP.PRO	2.000	PC	VM2471A0	BL SP LOWER CLAMP INT LOCK GLASS SLIDER	1.000	PC	VM2472A0	BL SP UPPER CLAMP INT LOCK GLASS SLIDER	1.000	PC	VM2473A0	BL SP INT GLASS HINGE LOWER LOCK PIN	1.000	PC	VM2474A0	BL SP INT GLASS HINGE UPPER LOCK PIN	1.000	PC	VM2478A0	BL SP GLASS H4 PUSHING BRACKET	4.000	PC	VM2489A0	SP HANDLE END KIT + STYLUS KIT	1.000	PC	VM2504A0	DOWEL TO GUIDE SLIDE SPRING SHOP.PRO	2.000	PC	VM2527A0	STYLUS PEN FOR SP	1.000	PC	VT1323A0	SP STEFANIA 357x364x4 EXTERNAL GLASS				1.000 PC
Code	Description	Qty	UOM																																																																
VM2465A0	SP SIDE-OPENIN G DOOR RIGHT LOWER CAP KIT	1.000	PC																																																																
VM2466A0	BL SP LEFT LOWER LATERAL DOOR CAP	1.000	PC																																																																
VM2467A0	SP SIDE-OPENIN G DOOR RIGHT UPPER CAP KIT	1.000	PC																																																																
VM2468A0	BL SP LEFT UPPER LATERAL DOOR CAP	1.000	PC																																																																
VM2470A0	SLIDE TO FIX INTERNAL GLASS SHOP.PRO	2.000	PC																																																																
VM2471A0	BL SP LOWER CLAMP INT LOCK GLASS SLIDER	1.000	PC																																																																
VM2472A0	BL SP UPPER CLAMP INT LOCK GLASS SLIDER	1.000	PC																																																																
VM2473A0	BL SP INT GLASS HINGE LOWER LOCK PIN	1.000	PC																																																																
VM2474A0	BL SP INT GLASS HINGE UPPER LOCK PIN	1.000	PC																																																																
VM2478A0	BL SP GLASS H4 PUSHING BRACKET	4.000	PC																																																																
VM2489A0	SP HANDLE END KIT + STYLUS KIT	1.000	PC																																																																
VM2504A0	DOWEL TO GUIDE SLIDE SPRING SHOP.PRO	2.000	PC																																																																
VM2527A0	STYLUS PEN FOR SP	1.000	PC																																																																
VT1323A0	SP STEFANIA 357x364x4 EXTERNAL GLASS				1.000 PC																																																														



COMPONENT			SPARE PART					
Code	Description	Image	Code	Description	Kit components			
VT1323A	SP STEFANIA 357x364x4 EXTERNAL GLASS		KDR1280A	BL SHOP.PRO STEFANIA COMPLETE DOOR KIT	Code	Description	Qty	UOM
					0B1285A0	0B1285A0	1.000	PC
					0B1286A0	0B1286A0	1.000	PC
					0B1287A0	0B1287A0	1.000	PC
					0B1288A0	0B1288A0	1.000	PC
					CR1111A0	BLSP STEFANIA DROPDOWN DOOR HINGE	2.000	PC
					LP1050A0	BL SHOP.PRO L180 COMPLETE LED BAR	1.000	PC
					SL1185A0		2.000	PC
					TB1562A0	DOOR LATERAL BEAM SP600	1.000	PC
					TB3301A0	TB3301A0	1.000	PC
					VI1014A0	STAINLESS STEEL WASHER 4.5X9X0.8	1.000	PC
					VI1147A0	5X25 STAINLESS STEEL SCREW	10.000	PC
					VI1220A1	4,2x12 TCB SELF-TAPPIN G SCREW	10.000	PC
					VI1280A3	M5x10 TC1/2T SCREW	6.000	PC
					VI1998A0	ZINC PLATED SCREW 5X30 TCB	2.000	PC
					VM1339A0		1.000	PC
					VM1630A1	INTERNAL GLASS PUSHING CAP	1.000	PC
					VM2456A0	BAKERLUX SHOP.PRO HANDLE END	1.000	PC
					VM2461A0	BL SP RIGHT LOWER DROPDOWN DOOR CAP KIT	1.000	PC
					VM2462A0	BL SP LEFT LOWER DROPDOWN DOOR CAP	1.000	PC
VM2463A0	SHOP.PRO RIGHT UPPER CAP DROP DOWN DOOR	1.000	PC					
VM2464A0	SHOP.PRO LEFT UPPER CAP DROP DOWN DOOR	1.000	PC					



COMPONENT			SPARE PART																																						
Code	Description	Image	Code	Description	Kit components																																				
VT1323A	SP STEFANIA 357x364x4 EXTERNAL GLASS		KDR1280A	BL SHOP.PRO STEFANIA COMPLETE DOOR KIT	<table border="1"> <thead> <tr> <th>Code</th> <th>Description</th> <th>Qty</th> <th>UOM</th> </tr> </thead> <tbody> <tr> <td>VM2471A0</td> <td>BL SP LOWER CLAMP INT LOCK GLASS SLIDER</td> <td>1.000</td> <td>PC</td> </tr> <tr> <td>VM2472A0</td> <td>BL SP UPPER CLAMP INT LOCK GLASS SLIDER</td> <td>1.000</td> <td>PC</td> </tr> <tr> <td>VM2478A0</td> <td>BL SP GLASS H4 PUSHING BRACKET</td> <td>1.000</td> <td>PC</td> </tr> <tr> <td>VM2489A0</td> <td>SP HANDLE END KIT + STYLUS KIT</td> <td>1.000</td> <td>PC</td> </tr> <tr> <td>VM2503A0</td> <td>SLIDE TO FIX INTERNAL NON REMOV GLASS SP</td> <td>2.000</td> <td>PC</td> </tr> <tr> <td>VM2527A0</td> <td>STYLUS PEN FOR SP</td> <td>1.000</td> <td>PC</td> </tr> <tr> <td>VT1323A0</td> <td>SP STEFANIA 357x364x4 EXTERNAL GLASS</td> <td>1.000</td> <td>PC</td> </tr> <tr> <td>VT1329A0</td> <td>SP STEFANIA 515x318.5x4 INNER GLASS</td> <td>1.000</td> <td>PC</td> </tr> </tbody> </table>	Code	Description	Qty	UOM	VM2471A0	BL SP LOWER CLAMP INT LOCK GLASS SLIDER	1.000	PC	VM2472A0	BL SP UPPER CLAMP INT LOCK GLASS SLIDER	1.000	PC	VM2478A0	BL SP GLASS H4 PUSHING BRACKET	1.000	PC	VM2489A0	SP HANDLE END KIT + STYLUS KIT	1.000	PC	VM2503A0	SLIDE TO FIX INTERNAL NON REMOV GLASS SP	2.000	PC	VM2527A0	STYLUS PEN FOR SP	1.000	PC	VT1323A0	SP STEFANIA 357x364x4 EXTERNAL GLASS	1.000	PC	VT1329A0	SP STEFANIA 515x318.5x4 INNER GLASS	1.000	PC
					Code	Description	Qty	UOM																																	
					VM2471A0	BL SP LOWER CLAMP INT LOCK GLASS SLIDER	1.000	PC																																	
					VM2472A0	BL SP UPPER CLAMP INT LOCK GLASS SLIDER	1.000	PC																																	
					VM2478A0	BL SP GLASS H4 PUSHING BRACKET	1.000	PC																																	
					VM2489A0	SP HANDLE END KIT + STYLUS KIT	1.000	PC																																	
					VM2503A0	SLIDE TO FIX INTERNAL NON REMOV GLASS SP	2.000	PC																																	
					VM2527A0	STYLUS PEN FOR SP	1.000	PC																																	
					VT1323A0	SP STEFANIA 357x364x4 EXTERNAL GLASS	1.000	PC																																	
					VT1329A0	SP STEFANIA 515x318.5x4 INNER GLASS	1.000	PC																																	
VT1329A	SP STEFANIA 515x318.5x4 INNER GLASS		KVT1329A	BL SP STEFANIA INTERNAL DOOR GLASS KIT	<table border="1"> <thead> <tr> <th>Code</th> <th>Description</th> <th>Qty</th> <th>UOM</th> </tr> </thead> <tbody> <tr> <td>VT1329A0</td> <td>SP STEFANIA 515x318.5x4 INNER GLASS</td> <td>1.000</td> <td>PC</td> </tr> </tbody> </table>	Code	Description	Qty	UOM	VT1329A0	SP STEFANIA 515x318.5x4 INNER GLASS	1.000	PC																												
Code	Description	Qty	UOM																																						
VT1329A0	SP STEFANIA 515x318.5x4 INNER GLASS	1.000	PC																																						



ASM3438A/0.D01 - Electrical system

FRONT

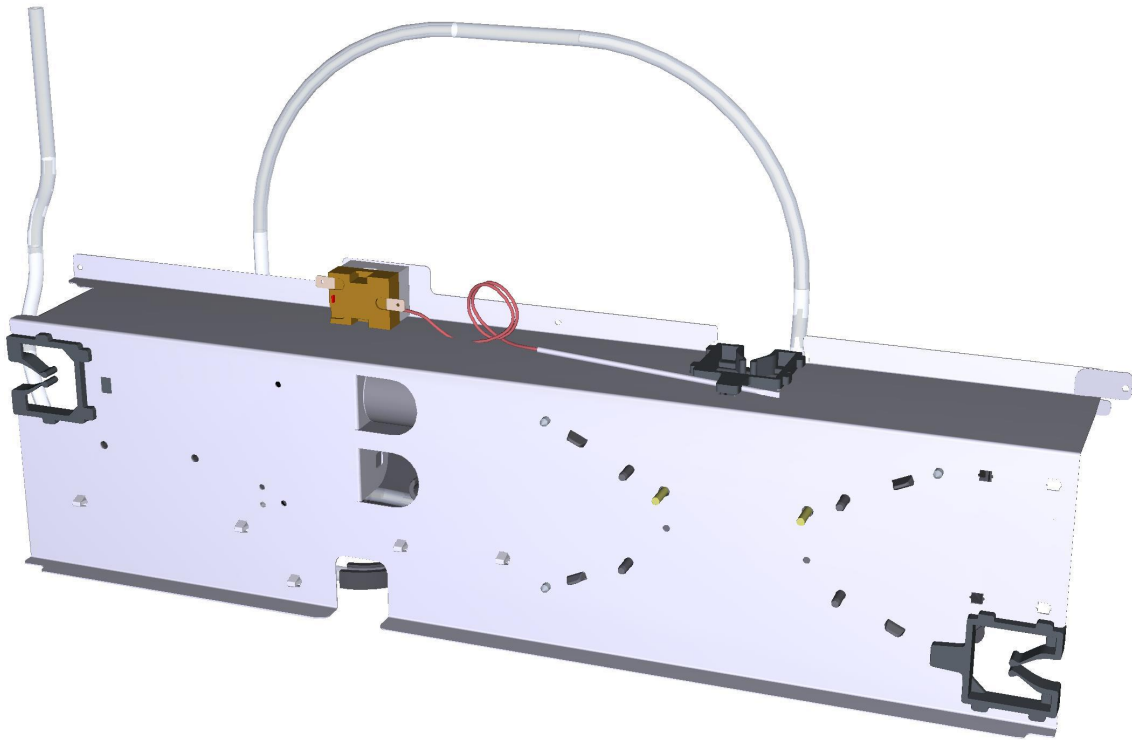



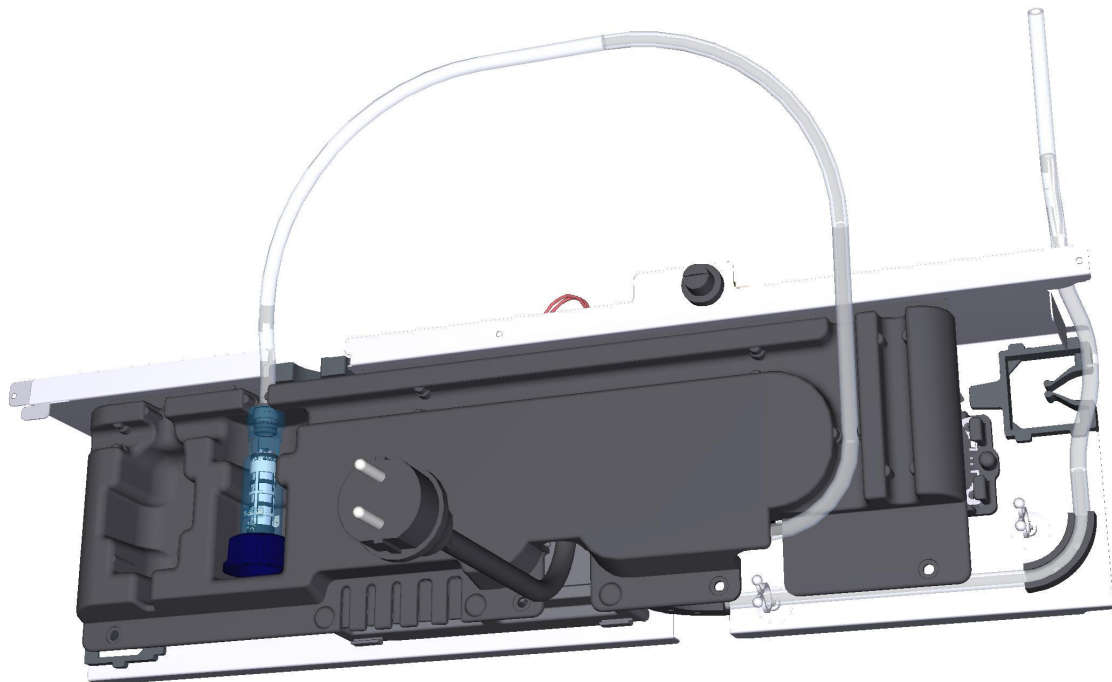

ASM3438A/0.D01 - Electrical system

REAR





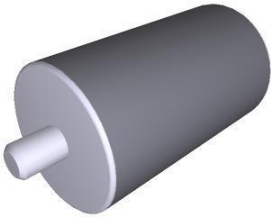





COMPONENT			SPARE PART																		
Code	Description	Image	Code	Description	Kit components																
0P1021A	COMPONENTS HOLDING PANEL STE-ARI SP		0P1021A0	COMPONENTS HOLDING PANEL STE-ARI SP																	
VE1115A	20 A 230V 4 POLES MINICONTRACTOR		KVE1115A	20A 230V 4 POLES MINICONTRACTOR KI	<table border="1"> <thead> <tr> <th>Code</th> <th>Description</th> <th>Qty</th> <th>UOM</th> </tr> </thead> <tbody> <tr> <td>VE1115A0</td> <td>20 A 230V 4 POLES MINICONTRACT OR</td> <td>1.000</td> <td>PC</td> </tr> <tr> <td>VM1075A1</td> <td>PLASTIC CLIP TO FIX CONTACTORS</td> <td>4.000</td> <td>PC</td> </tr> </tbody> </table>	Code	Description	Qty	UOM	VE1115A0	20 A 230V 4 POLES MINICONTRACT OR	1.000	PC	VM1075A1	PLASTIC CLIP TO FIX CONTACTORS	4.000	PC				
Code	Description	Qty	UOM																		
VE1115A0	20 A 230V 4 POLES MINICONTRACT OR	1.000	PC																		
VM1075A1	PLASTIC CLIP TO FIX CONTACTORS	4.000	PC																		
VM1056A	SMALL CONTACTOR BRACKET VE1115A		VM1056A0	SMALL CONTACTOR BRACKET VE1115A																	
VL1145A	VL1145A0		KVL1145A	3/4-JG8 FITTING WITH FILTER AND NRV KIT	<table border="1"> <thead> <tr> <th>Code</th> <th>Description</th> <th>Qty</th> <th>UOM</th> </tr> </thead> <tbody> <tr> <td>VL1145A1</td> <td></td> <td>1.000</td> <td>PC</td> </tr> </tbody> </table>	Code	Description	Qty	UOM	VL1145A1		1.000	PC								
Code	Description	Qty	UOM																		
VL1145A1		1.000	PC																		
PE2102A	BL LED/TOUCH/PLUS 230 V POWER CARD		KPE2102A	BL LED/TOUCH/MASTE R 230V POWER CARD KIT	<table border="1"> <thead> <tr> <th>Code</th> <th>Description</th> <th>Qty</th> <th>UOM</th> </tr> </thead> <tbody> <tr> <td>PE2102A2</td> <td>BL LED/TOUCH/P LUS 230V POWER BOAR</td> <td>1.000</td> <td>PC</td> </tr> <tr> <td>VI1988A0</td> <td>AUTOTHREAD ING SCREW 4,2x19 TCB+ INOX</td> <td>3.000</td> <td>PC</td> </tr> <tr> <td>VM1187A0</td> <td>POWER BOARD FRAME SHOP.PRO</td> <td>1.000</td> <td>PC</td> </tr> </tbody> </table>	Code	Description	Qty	UOM	PE2102A2	BL LED/TOUCH/P LUS 230V POWER BOAR	1.000	PC	VI1988A0	AUTOTHREAD ING SCREW 4,2x19 TCB+ INOX	3.000	PC	VM1187A0	POWER BOARD FRAME SHOP.PRO	1.000	PC
Code	Description	Qty	UOM																		
PE2102A2	BL LED/TOUCH/P LUS 230V POWER BOAR	1.000	PC																		
VI1988A0	AUTOTHREAD ING SCREW 4,2x19 TCB+ INOX	3.000	PC																		
VM1187A0	POWER BOARD FRAME SHOP.PRO	1.000	PC																		

COMPONENT			SPARE PART																		
Code	Description	Image	Code	Description	Kit components																
VM1187A	POWER BOARD FRAME SHOP.PRO		VM1187A0	POWER BOARD FRAME SHOP.PRO																	
CE1581A	CABLE H07RNF 3G1.5 L1.5MT+K1/6+SCHU KO		KCE1581A	H07RNF 3G1.5 L1.5 MT + SHUKO PLUG KIT	<table border="1"> <thead> <tr> <th>Code</th> <th>Description</th> <th>Qty</th> <th>UOM</th> </tr> </thead> <tbody> <tr> <td>CE1581A0</td> <td>CABLE H07RNF 3G1.5 L1.5MT+K1/6+ SCHUKO</td> <td>1.000</td> <td>PC</td> </tr> </tbody> </table>	Code	Description	Qty	UOM	CE1581A0	CABLE H07RNF 3G1.5 L1.5MT+K1/6+ SCHUKO	1.000	PC								
Code	Description	Qty	UOM																		
CE1581A0	CABLE H07RNF 3G1.5 L1.5MT+K1/6+ SCHUKO	1.000	PC																		
CN1003A	6,3 Uf MOTOR CAPACITOR		KCN1003A	6,3 uF MOTOR CAPACITOR KIT	<table border="1"> <thead> <tr> <th>Code</th> <th>Description</th> <th>Qty</th> <th>UOM</th> </tr> </thead> <tbody> <tr> <td>CN1003A0</td> <td>6,3 Uf MOTOR CAPACITOR</td> <td>1.000</td> <td>PC</td> </tr> <tr> <td>V11931A0</td> <td>M8x1.65 H4 CH13 ZINC PLATED NUT</td> <td>1.000</td> <td>PC</td> </tr> <tr> <td>V11932A0</td> <td>D8 INDENTED ZINC PLATED WASHER</td> <td>1.000</td> <td>PC</td> </tr> </tbody> </table>	Code	Description	Qty	UOM	CN1003A0	6,3 Uf MOTOR CAPACITOR	1.000	PC	V11931A0	M8x1.65 H4 CH13 ZINC PLATED NUT	1.000	PC	V11932A0	D8 INDENTED ZINC PLATED WASHER	1.000	PC
Code	Description	Qty	UOM																		
CN1003A0	6,3 Uf MOTOR CAPACITOR	1.000	PC																		
V11931A0	M8x1.65 H4 CH13 ZINC PLATED NUT	1.000	PC																		
V11932A0	D8 INDENTED ZINC PLATED WASHER	1.000	PC																		
MR1025A	3 POLES 450V 41A+GROUND TERMINAL BLOCK		KMR1025A	3 POLES TERMINAL BLOCK KIT	<table border="1"> <thead> <tr> <th>Code</th> <th>Description</th> <th>Qty</th> <th>UOM</th> </tr> </thead> <tbody> <tr> <td>MR1025A1</td> <td>3 POLES 450V 41A+GROUND TERMINAL BLOCK</td> <td>1.000</td> <td>PC</td> </tr> </tbody> </table>	Code	Description	Qty	UOM	MR1025A1	3 POLES 450V 41A+GROUND TERMINAL BLOCK	1.000	PC								
Code	Description	Qty	UOM																		
MR1025A1	3 POLES 450V 41A+GROUND TERMINAL BLOCK	1.000	PC																		
RC1006A	D8 PET PIPE GUIDE BEND		KRC1006A	20 PCS. Ø8 PET PIPE GUIDE BEND KI	<table border="1"> <thead> <tr> <th>Code</th> <th>Description</th> <th>Qty</th> <th>UOM</th> </tr> </thead> <tbody> <tr> <td>RC1006A0</td> <td>D8 PET PIPE GUIDE BEND</td> <td>20.000</td> <td>PC</td> </tr> </tbody> </table>	Code	Description	Qty	UOM	RC1006A0	D8 PET PIPE GUIDE BEND	20.000	PC								
Code	Description	Qty	UOM																		
RC1006A0	D8 PET PIPE GUIDE BEND	20.000	PC																		



COMPONENT			SPARE PART																										
Code	Description	Image	Code	Description	Kit components																								
TB3280A	TB3280A0		KTB2529A	Ø8 TRANSPARENT HUMIDITY PIPE 2 M KIT	<table border="1"> <thead> <tr> <th>Code</th> <th>Description</th> <th>Qty</th> <th>UOM</th> </tr> </thead> <tbody> <tr> <td>TB1815A0</td> <td>7,93x4,75 PE TRANSP. PIPE (JG #PE08100N)</td> <td>2.000</td> <td>M</td> </tr> </tbody> </table>	Code	Description	Qty	UOM	TB1815A0	7,93x4,75 PE TRANSP. PIPE (JG #PE08100N)	2.000	M																
			Code	Description	Qty	UOM																							
TB1815A0	7,93x4,75 PE TRANSP. PIPE (JG #PE08100N)	2.000	M																										
KTB1959A	Ø8 TB1815 TRANSPARENT PIPE 5M KIT	<table border="1"> <thead> <tr> <th>Code</th> <th>Description</th> <th>Qty</th> <th>UOM</th> </tr> </thead> <tbody> <tr> <td>TB1815A0</td> <td>7,93x4,75 PE TRANSP. PIPE (JG #PE08100N)</td> <td>5.000</td> <td>M</td> </tr> </tbody> </table>	Code	Description	Qty	UOM	TB1815A0	7,93x4,75 PE TRANSP. PIPE (JG #PE08100N)	5.000	M																			
Code	Description	Qty	UOM																										
TB1815A0	7,93x4,75 PE TRANSP. PIPE (JG #PE08100N)	5.000	M																										
TR1136A	318°C -0/+24 1 POLE SAFETY THERMOSTAT		KTR1136A	318°C -0/+24 SAFETY THERMOSTAT KIT	<table border="1"> <thead> <tr> <th>Code</th> <th>Description</th> <th>Qty</th> <th>UOM</th> </tr> </thead> <tbody> <tr> <td>0H7030A0</td> <td>THERMOSTAT BULB INLET COVER</td> <td>1.000</td> <td>PC</td> </tr> <tr> <td>GN1531A0</td> <td>THERMOSTAT BULB INLET SEALING</td> <td>1.000</td> <td>PC</td> </tr> <tr> <td>SL1045A0</td> <td>S57 BLACK SILICONE - 80ml CARTRIDGE</td> <td>1.000</td> <td>PC</td> </tr> <tr> <td>TR1136A0</td> <td>318°C -0/+24 1 POLE SAFETY THERMOSTAT</td> <td>1.000</td> <td>PC</td> </tr> <tr> <td>VI1220A1</td> <td>4,2x12 TCB SELF-TAPPING SCREW</td> <td>3.000</td> <td>PC</td> </tr> </tbody> </table>	Code	Description	Qty	UOM	0H7030A0	THERMOSTAT BULB INLET COVER	1.000	PC	GN1531A0	THERMOSTAT BULB INLET SEALING	1.000	PC	SL1045A0	S57 BLACK SILICONE - 80ml CARTRIDGE	1.000	PC	TR1136A0	318°C -0/+24 1 POLE SAFETY THERMOSTAT	1.000	PC	VI1220A1	4,2x12 TCB SELF-TAPPING SCREW	3.000	PC
					Code	Description	Qty	UOM																					
					0H7030A0	THERMOSTAT BULB INLET COVER	1.000	PC																					
					GN1531A0	THERMOSTAT BULB INLET SEALING	1.000	PC																					
					SL1045A0	S57 BLACK SILICONE - 80ml CARTRIDGE	1.000	PC																					
					TR1136A0	318°C -0/+24 1 POLE SAFETY THERMOSTAT	1.000	PC																					
VI1220A1	4,2x12 TCB SELF-TAPPING SCREW	3.000	PC																										
VI1328A	VI1328A0		VI1328A0	VI1328A0																									
VM1188A	POWER BOARD WIRES PASS-THROUGH		KVM1188A	POWER BOARD WIRES PASS-THROUGH 10PCS KIT	<table border="1"> <thead> <tr> <th>Code</th> <th>Description</th> <th>Qty</th> <th>UOM</th> </tr> </thead> <tbody> <tr> <td>VM1188A0</td> <td>POWER BOARD WIRES PASS-THROUGH GH</td> <td>10.000</td> <td>PC</td> </tr> </tbody> </table>	Code	Description	Qty	UOM	VM1188A0	POWER BOARD WIRES PASS-THROUGH GH	10.000	PC																
					Code	Description	Qty	UOM																					
VM1188A0	POWER BOARD WIRES PASS-THROUGH GH	10.000	PC																										

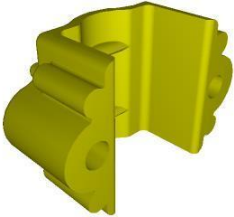

COMPONENT			SPARE PART														
Code	Description	Image	Code	Description	Kit components												
VM2482A	ELECTR COMPONENTS HOLDER FRAME SHOP.PRO		KVM2482A	BAKERLUX SP ELECTR COMPONENTS HOLDER KIT	<table border="1"> <thead> <tr> <th>Code</th> <th>Description</th> <th>Qty</th> <th>UOM</th> </tr> </thead> <tbody> <tr> <td>VM2482A0</td> <td>ELECTR COMPONENT S HOLDER FRAME SHOP.PRO</td> <td>1.000</td> <td>PC</td> </tr> <tr> <td>VM2484A0</td> <td>ELECTRICAL CONNECTION CABLE CLAMP</td> <td>1.000</td> <td>PC</td> </tr> </tbody> </table>	Code	Description	Qty	UOM	VM2482A0	ELECTR COMPONENT S HOLDER FRAME SHOP.PRO	1.000	PC	VM2484A0	ELECTRICAL CONNECTION CABLE CLAMP	1.000	PC
					Code	Description	Qty	UOM									
VM2482A0	ELECTR COMPONENT S HOLDER FRAME SHOP.PRO	1.000	PC														
VM2484A0	ELECTRICAL CONNECTION CABLE CLAMP	1.000	PC														
<table border="1"> <thead> <tr> <th>Code</th> <th>Description</th> <th>Qty</th> <th>UOM</th> </tr> </thead> <tbody> <tr> <td>VM2483A1</td> <td>SHOP PRO COMPONENT S HOLDER COVER</td> <td>1.000</td> <td>PC</td> </tr> </tbody> </table>	Code	Description	Qty	UOM	VM2483A1	SHOP PRO COMPONENT S HOLDER COVER	1.000	PC									
Code	Description	Qty	UOM														
VM2483A1	SHOP PRO COMPONENT S HOLDER COVER	1.000	PC														
VM2483A	SHOP PRO COMPONENTS HOLDER COVER		KVM2483A	BL SHOP.PRO COMPONENTS HOLDER COVER KIT	<table border="1"> <thead> <tr> <th>Code</th> <th>Description</th> <th>Qty</th> <th>UOM</th> </tr> </thead> <tbody> <tr> <td>VM2483A1</td> <td>SHOP PRO COMPONENT S HOLDER COVER</td> <td>1.000</td> <td>PC</td> </tr> </tbody> </table>	Code	Description	Qty	UOM	VM2483A1	SHOP PRO COMPONENT S HOLDER COVER	1.000	PC				
Code	Description	Qty	UOM														
VM2483A1	SHOP PRO COMPONENT S HOLDER COVER	1.000	PC														
VM2484A	ELECTRICAL CONNECTION CABLE CLAMP		KVM2484A	CABLE LOCKS ELECTRICAL CONNECTION KIT	<table border="1"> <thead> <tr> <th>Code</th> <th>Description</th> <th>Qty</th> <th>UOM</th> </tr> </thead> <tbody> <tr> <td>VM2484A0</td> <td>ELECTRICAL CONNECTION CABLE CLAMP</td> <td>1.000</td> <td>PC</td> </tr> </tbody> </table>	Code	Description	Qty	UOM	VM2484A0	ELECTRICAL CONNECTION CABLE CLAMP	1.000	PC				
			Code	Description	Qty	UOM											
			VM2484A0	ELECTRICAL CONNECTION CABLE CLAMP	1.000	PC											
KVM2482A	BAKERLUX SP ELECTR COMPONENTS HOLDER KIT	<table border="1"> <thead> <tr> <th>Code</th> <th>Description</th> <th>Qty</th> <th>UOM</th> </tr> </thead> <tbody> <tr> <td>VM2482A0</td> <td>ELECTR COMPONENT S HOLDER FRAME SHOP.PRO</td> <td>1.000</td> <td>PC</td> </tr> <tr> <td>VM2484A0</td> <td>ELECTRICAL CONNECTION CABLE CLAMP</td> <td>1.000</td> <td>PC</td> </tr> </tbody> </table>	Code	Description	Qty	UOM	VM2482A0	ELECTR COMPONENT S HOLDER FRAME SHOP.PRO	1.000	PC	VM2484A0	ELECTRICAL CONNECTION CABLE CLAMP	1.000	PC			
Code	Description	Qty	UOM														
VM2482A0	ELECTR COMPONENT S HOLDER FRAME SHOP.PRO	1.000	PC														
VM2484A0	ELECTRICAL CONNECTION CABLE CLAMP	1.000	PC														