

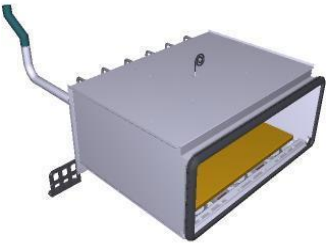

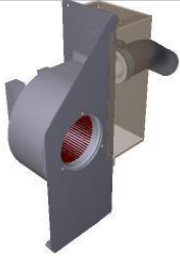

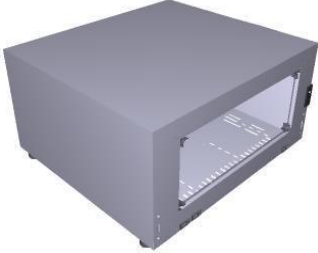

Assembly code	Assembly description	Assembly image
ASM1603A/0.D05	Cooking chamber	
ASM1668A/0.D01	General overview	
ASM4038C/0.D00	External cover	
ASM4039A/0.D02	Door	
ASM4070A/0.D01	General overview	

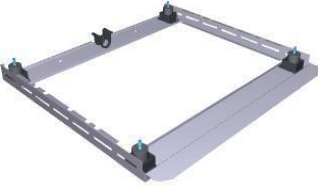

Assembly code	Assembly description	Assembly image
ASM4070A/0.D01	General overview	
ASM4073B/0.D00	General overview	

ASM1603A/0.D05 - Cooking chamber

FRONT

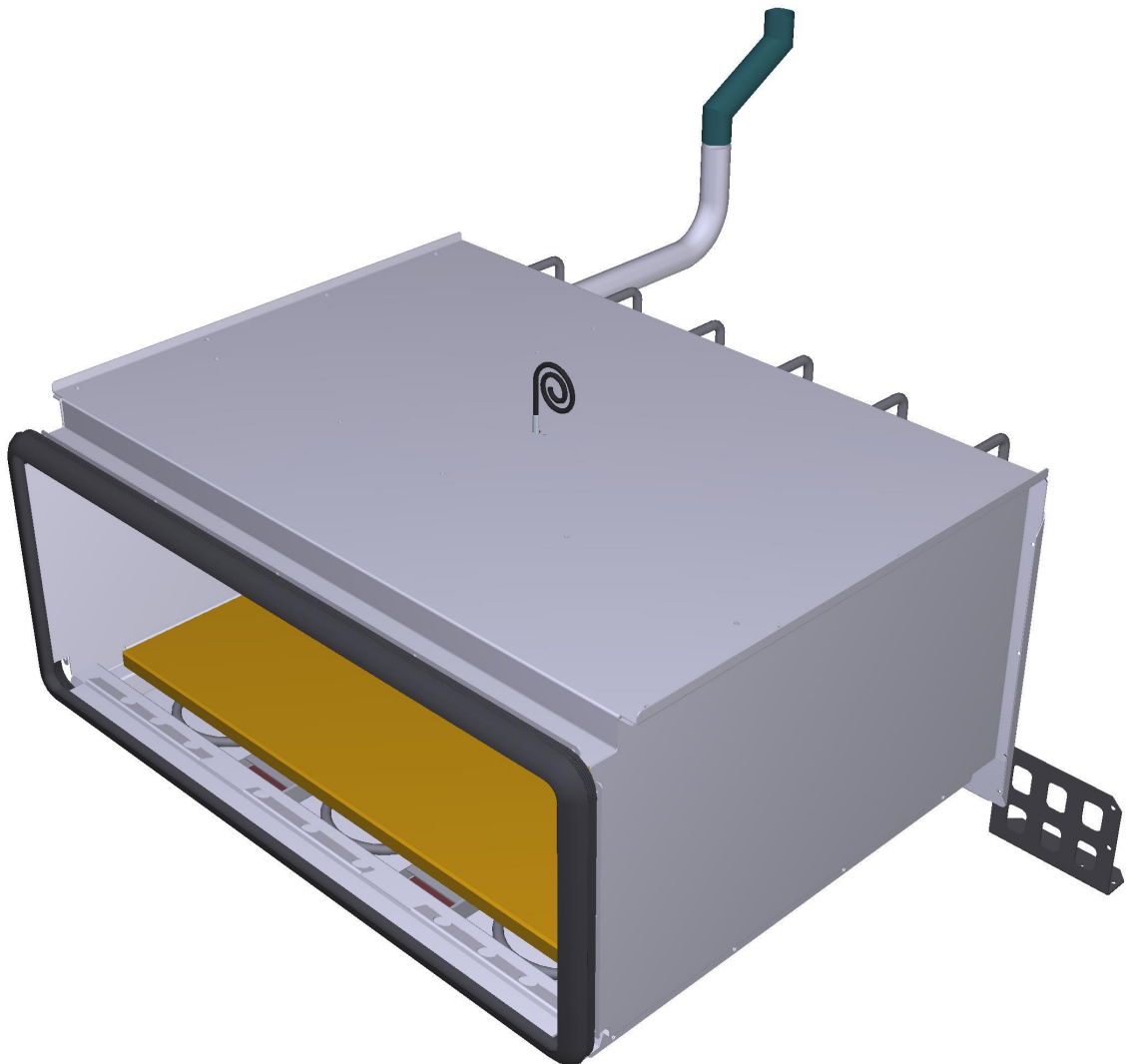





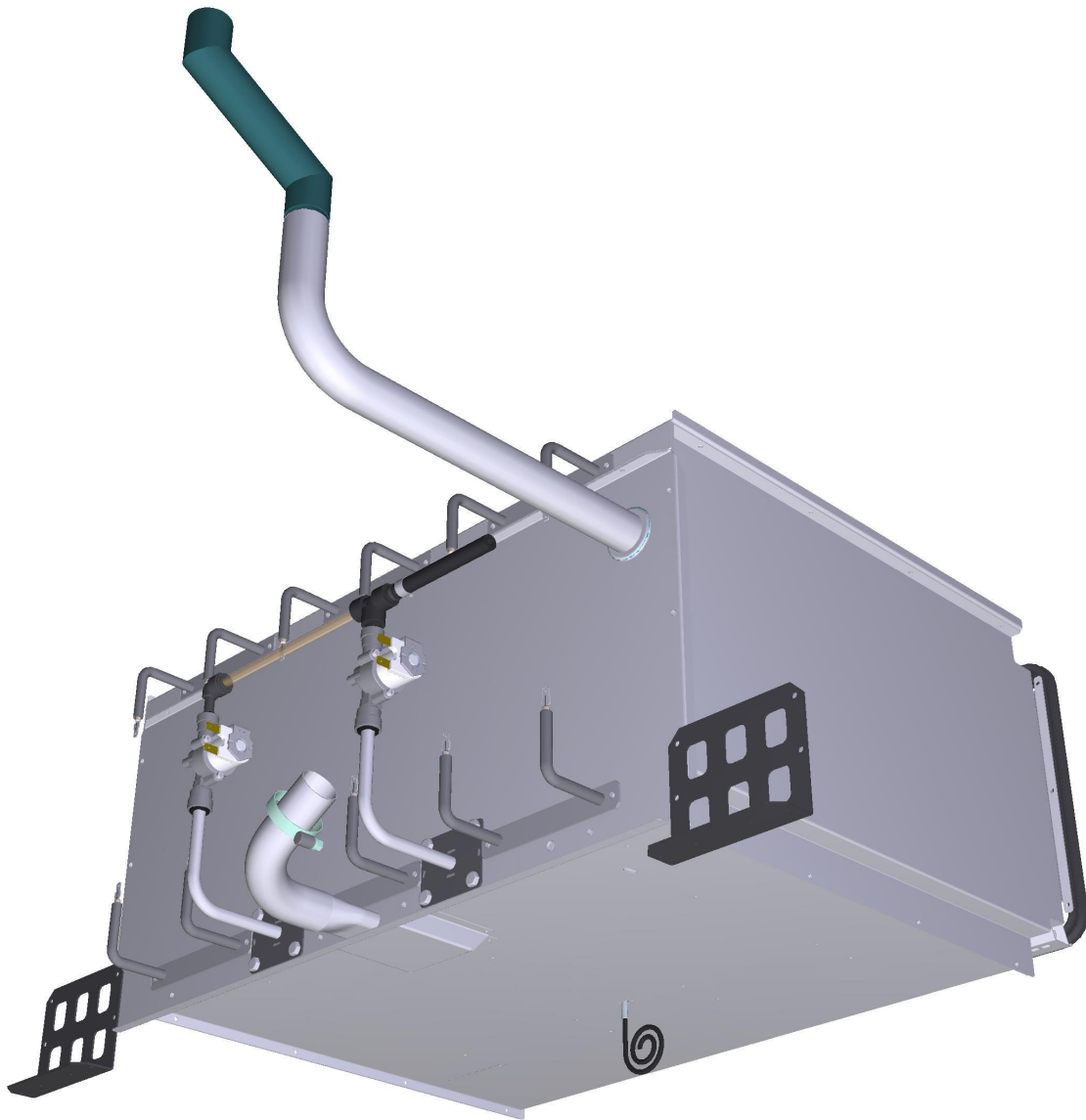

ASM1603A/0.D05 - Cooking chamber



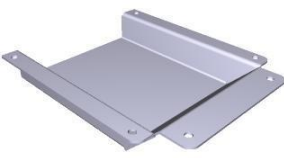

REAR







COMPONENT			SPARE PART																		
Code	Description	Image	Code	Description	Kit components																
0H1568A	DECK OVEN SAFETY THERMOSTAT COVER		0H1568A0	DECK OVEN SAFETY THERMOSTAT COVER																	
0H4820A	BULB HOLDING BRACKET		0H4820A1	BULB HOLDING BRACKET																	
0H7167A	L PLATE COMPENSATION FOR DECK STONE		0H7167A0	L PLATE COMPENSATION FOR DECK STONE																	
0H6919A	DECK OVEN VENTURI CHAMBER		0H6919A0	DECK OVEN VENTURI CHAMBER																	
RC1378A	HOSE CLAMP		KVM2379A	MM 200V VENTURI ACTUATOR SYSTEM KIT	<table border="1"> <thead> <tr> <th>Code</th> <th>Description</th> <th>Qty</th> <th>UOM</th> </tr> </thead> <tbody> <tr> <td>RC1378A0</td> <td>HOSE CLAMP</td> <td>3.000</td> <td>PC</td> </tr> <tr> <td>TB1520A0</td> <td>Int. Ø=38 TH=4 DRAIN BLACK RUBBER PIPE</td> <td>0.120</td> <td>M</td> </tr> <tr> <td>VM2379A1</td> <td></td> <td>1.000</td> <td>PC</td> </tr> </tbody> </table>	Code	Description	Qty	UOM	RC1378A0	HOSE CLAMP	3.000	PC	TB1520A0	Int. Ø=38 TH=4 DRAIN BLACK RUBBER PIPE	0.120	M	VM2379A1		1.000	PC
			Code		Description	Qty	UOM														
RC1378A0	HOSE CLAMP	3.000	PC																		
TB1520A0	Int. Ø=38 TH=4 DRAIN BLACK RUBBER PIPE	0.120	M																		
VM2379A1		1.000	PC																		
KVM2378A	MM 240V VENTURI ACTUATOR SYSTEM KIT	<table border="1"> <thead> <tr> <th>Code</th> <th>Description</th> <th>Qty</th> <th>UOM</th> </tr> </thead> <tbody> <tr> <td>RC1378A0</td> <td>HOSE CLAMP</td> <td>3.000</td> <td>PC</td> </tr> <tr> <td>TB1520A0</td> <td>Int. Ø=38 TH=4 DRAIN BLACK RUBBER PIPE</td> <td>0.120</td> <td>M</td> </tr> <tr> <td>VM2378A1</td> <td></td> <td>1.000</td> <td>PC</td> </tr> </tbody> </table>	Code	Description	Qty	UOM	RC1378A0	HOSE CLAMP	3.000	PC	TB1520A0	Int. Ø=38 TH=4 DRAIN BLACK RUBBER PIPE	0.120	M	VM2378A1		1.000	PC			
Code		Description	Qty	UOM																	
RC1378A0	HOSE CLAMP	3.000	PC																		
TB1520A0	Int. Ø=38 TH=4 DRAIN BLACK RUBBER PIPE	0.120	M																		
VM2378A1		1.000	PC																		

COMPONENT			SPARE PART																			
Code	Description	Image	Code	Description	Kit components																	
RC1378A	HOSE CLAMP		KVM2377A	MM 220 V VENTURI ACTUATOR SYSTEM KIT	<table border="1"> <thead> <tr> <th>Code</th> <th>Description</th> <th>Qty</th> <th>UOM</th> </tr> </thead> <tbody> <tr> <td>RC1378A0</td> <td>HOSE CLAMP</td> <td>3.000</td> <td>PC</td> </tr> <tr> <td>TB1520A0</td> <td>Int. Ø=38 TH=4 DRAIN BLACK RUBBER PIPE</td> <td>0.120</td> <td>M</td> </tr> <tr> <td>VM2377A1</td> <td>220 V 50/60 HZ EUR VENTURI SET</td> <td>1.000</td> <td>PC</td> </tr> </tbody> </table>	Code	Description	Qty	UOM	RC1378A0	HOSE CLAMP	3.000	PC	TB1520A0	Int. Ø=38 TH=4 DRAIN BLACK RUBBER PIPE	0.120	M	VM2377A1	220 V 50/60 HZ EUR VENTURI SET	1.000	PC	
			Code	Description	Qty	UOM																
			RC1378A0	HOSE CLAMP	3.000	PC																
TB1520A0	Int. Ø=38 TH=4 DRAIN BLACK RUBBER PIPE	0.120	M																			
VM2377A1	220 V 50/60 HZ EUR VENTURI SET	1.000	PC																			
KVE1140A	S.5/5E JAPAN VERSION VENTURI COIL KIT	<table border="1"> <thead> <tr> <th>Code</th> <th>Description</th> <th>Qty</th> <th>UOM</th> </tr> </thead> <tbody> <tr> <td>RC1378A0</td> <td>HOSE CLAMP</td> <td>2.000</td> <td>PC</td> </tr> <tr> <td>TB1520A0</td> <td>Int. Ø=38 TH=4 DRAIN BLACK RUBBER PIPE</td> <td>0.050</td> <td>M</td> </tr> <tr> <td>VI1220A1</td> <td>4,2x12 TCB SELF-TAPPIN G SCREW</td> <td>1.000</td> <td>PC</td> </tr> <tr> <td>VM2632A0</td> <td></td> <td>1.000</td> <td>PC</td> </tr> </tbody> </table>	Code	Description	Qty	UOM	RC1378A0	HOSE CLAMP	2.000	PC	TB1520A0	Int. Ø=38 TH=4 DRAIN BLACK RUBBER PIPE	0.050	M	VI1220A1	4,2x12 TCB SELF-TAPPIN G SCREW	1.000	PC	VM2632A0		1.000	PC
Code	Description	Qty	UOM																			
RC1378A0	HOSE CLAMP	2.000	PC																			
TB1520A0	Int. Ø=38 TH=4 DRAIN BLACK RUBBER PIPE	0.050	M																			
VI1220A1	4,2x12 TCB SELF-TAPPIN G SCREW	1.000	PC																			
VM2632A0		1.000	PC																			
KVE1014A	US VERSION SERIES 5 VENTURI COIL KIT	<table border="1"> <thead> <tr> <th>Code</th> <th>Description</th> <th>Qty</th> <th>UOM</th> </tr> </thead> <tbody> <tr> <td>RC1378A0</td> <td>HOSE CLAMP</td> <td>2.000</td> <td>PC</td> </tr> <tr> <td>TB1520A0</td> <td>Int. Ø=38 TH=4 DRAIN BLACK RUBBER PIPE</td> <td>0.050</td> <td>M</td> </tr> <tr> <td>VM2633A0</td> <td></td> <td>1.000</td> <td>PC</td> </tr> </tbody> </table>	Code	Description	Qty	UOM	RC1378A0	HOSE CLAMP	2.000	PC	TB1520A0	Int. Ø=38 TH=4 DRAIN BLACK RUBBER PIPE	0.050	M	VM2633A0		1.000	PC				
Code	Description	Qty	UOM																			
RC1378A0	HOSE CLAMP	2.000	PC																			
TB1520A0	Int. Ø=38 TH=4 DRAIN BLACK RUBBER PIPE	0.050	M																			
VM2633A0		1.000	PC																			
			KRC1378A	HOSE CLAMP 10 PCS KIT	<table border="1"> <thead> <tr> <th>Code</th> <th>Description</th> <th>Qty</th> <th>UOM</th> </tr> </thead> <tbody> <tr> <td>RC1378A0</td> <td>HOSE CLAMP</td> <td>10.000</td> <td>PC</td> </tr> </tbody> </table>	Code	Description	Qty	UOM	RC1378A0	HOSE CLAMP	10.000	PC									
Code	Description	Qty	UOM																			
RC1378A0	HOSE CLAMP	10.000	PC																			
EL1250A	WATER SOLENOID VALVE 1-WAY RED		KEL1250A	1 WAY SOLENOID VALVE KIT J.G.D8 D1	<table border="1"> <thead> <tr> <th>Code</th> <th>Description</th> <th>Qty</th> <th>UOM</th> </tr> </thead> <tbody> <tr> <td>EL1250A0</td> <td>WATER SOLENOID VALVE 1-WAY RED</td> <td>1.000</td> <td>PC</td> </tr> </tbody> </table>	Code	Description	Qty	UOM	EL1250A0	WATER SOLENOID VALVE 1-WAY RED	1.000	PC									
Code	Description	Qty	UOM																			
EL1250A0	WATER SOLENOID VALVE 1-WAY RED	1.000	PC																			
EL1020A	D8 INTERMEDIATE T-SHAPED FITTING		KEL1020A	Ø8 T-SHAPED FITTING 10 PCS KIT	<table border="1"> <thead> <tr> <th>Code</th> <th>Description</th> <th>Qty</th> <th>UOM</th> </tr> </thead> <tbody> <tr> <td>EL1020A1</td> <td>D8 INTERMEDIATE T-SHAPED FITTING</td> <td>10.000</td> <td>PC</td> </tr> </tbody> </table>	Code	Description	Qty	UOM	EL1020A1	D8 INTERMEDIATE T-SHAPED FITTING	10.000	PC									
Code	Description	Qty	UOM																			
EL1020A1	D8 INTERMEDIATE T-SHAPED FITTING	10.000	PC																			

COMPONENT			SPARE PART																		
Code	Description	Image	Code	Description	Kit components																
EL1195A	ELBOW UNION Ø8F-Ø8M		KEL1195A	D8F-D8M JG ELBOW FITTING 10 PCS KIT	<table border="1"> <thead> <tr> <th>Code</th> <th>Description</th> <th>Qty</th> <th>UOM</th> </tr> </thead> <tbody> <tr> <td>EL1195A0</td> <td>ELBOW UNION Ø8F-Ø8M</td> <td>10.000</td> <td>PC</td> </tr> </tbody> </table>	Code	Description	Qty	UOM	EL1195A0	ELBOW UNION Ø8F-Ø8M	10.000	PC								
Code	Description	Qty	UOM																		
EL1195A0	ELBOW UNION Ø8F-Ø8M	10.000	PC																		
TB1627A	TB3131A - WHITE-BLACK 6x12 L=0,5M		TB1627A1	TB3131A - WHITE-BLACK 6x12 L=0,5M																	
VL1047A	D6 PIPE HOLDER - D8 J.G. TERMINAL		KVL1047A	Ø6 PIPE HOLDER+Ø8 JG TERMINAL 10 PCS KIT	<table border="1"> <thead> <tr> <th>Code</th> <th>Description</th> <th>Qty</th> <th>UOM</th> </tr> </thead> <tbody> <tr> <td>VL1047A1</td> <td>D6 PIPE HOLDER - D8 J.G. TERMINAL</td> <td>10.000</td> <td>PC</td> </tr> </tbody> </table>	Code	Description	Qty	UOM	VL1047A1	D6 PIPE HOLDER - D8 J.G. TERMINAL	10.000	PC								
Code	Description	Qty	UOM																		
VL1047A1	D6 PIPE HOLDER - D8 J.G. TERMINAL	10.000	PC																		
			KVL0016A	BRITA ADAPTOR KIT FOR MM CLEANING SYSTEM	<table border="1"> <thead> <tr> <th>Code</th> <th>Description</th> <th>Qty</th> <th>UOM</th> </tr> </thead> <tbody> <tr> <td>EL1185A0</td> <td>Ø8F - Ø8F ELBOW CONNECTION</td> <td>260.000</td> <td>PC</td> </tr> <tr> <td>RC1018A0</td> <td>ZINC PLATED D12 ELASTIC CLAMP</td> <td>520.000</td> <td>PC</td> </tr> <tr> <td>VL1047A1</td> <td>D6 PIPE HOLDER - D8 J.G. TERMINAL</td> <td>520.000</td> <td>PC</td> </tr> </tbody> </table>	Code	Description	Qty	UOM	EL1185A0	Ø8F - Ø8F ELBOW CONNECTION	260.000	PC	RC1018A0	ZINC PLATED D12 ELASTIC CLAMP	520.000	PC	VL1047A1	D6 PIPE HOLDER - D8 J.G. TERMINAL	520.000	PC
Code	Description	Qty	UOM																		
EL1185A0	Ø8F - Ø8F ELBOW CONNECTION	260.000	PC																		
RC1018A0	ZINC PLATED D12 ELASTIC CLAMP	520.000	PC																		
VL1047A1	D6 PIPE HOLDER - D8 J.G. TERMINAL	520.000	PC																		
GN0078A	GN0078A0		GN0078A0	GN0078A0																	

COMPONENT			SPARE PART																														
Code	Description	Image	Code	Description	Kit components																												
TR1106B	PT100 L=2000 TEMPERATURE PROBE		KTR1106B	MIND.Maps L2000 CHAMBER TEMP. PROBE KIT	<table border="1"> <thead> <tr> <th>Code</th> <th>Description</th> <th>Qty</th> <th>UOM</th> </tr> </thead> <tbody> <tr> <td>GN1285A0</td> <td>NTC TEMPERATUR E PROBE SEALING</td> <td>1.000</td> <td>PC</td> </tr> <tr> <td>SL1045A0</td> <td>S57 BLACK SILICONE - 80ml CARTRIDGE</td> <td>1.000</td> <td>PC</td> </tr> <tr> <td>TR1106B0</td> <td>PT100 L=2000 TEMPERATUR E PROBE</td> <td>1.000</td> <td>PC</td> </tr> <tr> <td>VI1220A1</td> <td>4,2x12 TCB SELF-TAPPIN G SCREW</td> <td>2.000</td> <td>PC</td> </tr> <tr> <td>VM1464A1</td> <td>CT BT TEMPERATUR E PROBE COVER</td> <td>1.000</td> <td>PC</td> </tr> <tr> <td>VM1465A1</td> <td>CT BT TEMPERATUR E PROBE COVER</td> <td>1.000</td> <td>PC</td> </tr> </tbody> </table>	Code	Description	Qty	UOM	GN1285A0	NTC TEMPERATUR E PROBE SEALING	1.000	PC	SL1045A0	S57 BLACK SILICONE - 80ml CARTRIDGE	1.000	PC	TR1106B0	PT100 L=2000 TEMPERATUR E PROBE	1.000	PC	VI1220A1	4,2x12 TCB SELF-TAPPIN G SCREW	2.000	PC	VM1464A1	CT BT TEMPERATUR E PROBE COVER	1.000	PC	VM1465A1	CT BT TEMPERATUR E PROBE COVER	1.000	PC
					Code	Description	Qty	UOM																									
					GN1285A0	NTC TEMPERATUR E PROBE SEALING	1.000	PC																									
					SL1045A0	S57 BLACK SILICONE - 80ml CARTRIDGE	1.000	PC																									
					TR1106B0	PT100 L=2000 TEMPERATUR E PROBE	1.000	PC																									
					VI1220A1	4,2x12 TCB SELF-TAPPIN G SCREW	2.000	PC																									
VM1464A1	CT BT TEMPERATUR E PROBE COVER	1.000	PC																														
VM1465A1	CT BT TEMPERATUR E PROBE COVER	1.000	PC																														
GN1514A	XB264 DOOR GASKET 1676MM		KGN1514A	XB262-264 DOOR GASKET KIT	<table border="1"> <thead> <tr> <th>Code</th> <th>Description</th> <th>Qty</th> <th>UOM</th> </tr> </thead> <tbody> <tr> <td>GN1110A2</td> <td>Line Miss/XVC105-0 55/XK/XL DOOR GASKE</td> <td>1.680</td> <td>M</td> </tr> </tbody> </table>	Code	Description	Qty	UOM	GN1110A2	Line Miss/XVC105-0 55/XK/XL DOOR GASKE	1.680	M																				
					Code	Description	Qty	UOM																									
GN1110A2	Line Miss/XVC105-0 55/XK/XL DOOR GASKE	1.680	M																														
<table border="1"> <thead> <tr> <th>Code</th> <th>Description</th> <th>Qty</th> <th>UOM</th> </tr> </thead> <tbody> <tr> <td>RS1273A0</td> <td>450W 77V 1 TURN FLAT ELEMENT</td> <td>1.000</td> <td>PC</td> </tr> <tr> <td>SL1045A0</td> <td>S57 BLACK SILICONE - 80ml CARTRIDGE</td> <td>1.000</td> <td>PC</td> </tr> <tr> <td>VI1220A1</td> <td>4,2x12 TCB SELF-TAPPIN G SCREW</td> <td>2.000</td> <td>PC</td> </tr> <tr> <td>VM1794A0</td> <td>250x4.8 PA66 BLACK CLAMP</td> <td>2.000</td> <td>PC</td> </tr> <tr> <td>VM2103A0</td> <td>CLAMP LOCK</td> <td>2.000</td> <td>PC</td> </tr> </tbody> </table>	Code	Description	Qty	UOM	RS1273A0	450W 77V 1 TURN FLAT ELEMENT	1.000	PC	SL1045A0	S57 BLACK SILICONE - 80ml CARTRIDGE	1.000	PC	VI1220A1	4,2x12 TCB SELF-TAPPIN G SCREW	2.000	PC	VM1794A0	250x4.8 PA66 BLACK CLAMP	2.000	PC	VM2103A0	CLAMP LOCK	2.000	PC									
Code	Description	Qty	UOM																														
RS1273A0	450W 77V 1 TURN FLAT ELEMENT	1.000	PC																														
SL1045A0	S57 BLACK SILICONE - 80ml CARTRIDGE	1.000	PC																														
VI1220A1	4,2x12 TCB SELF-TAPPIN G SCREW	2.000	PC																														
VM1794A0	250x4.8 PA66 BLACK CLAMP	2.000	PC																														
VM2103A0	CLAMP LOCK	2.000	PC																														
RS1273A	450W 77V 1 TURN FLAT ELEMENT		KRS1273A	XB262E FLAT HEATING ELEMENT KIT																													

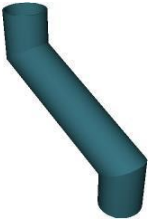

COMPONENT			SPARE PART										
<i>Code</i>	<i>Description</i>	<i>Image</i>	<i>Code</i>	<i>Description</i>	<i>Kit components</i>								
TB1765A	STACKING KIT CHIMNEY CONNECTING PIPE		KTB1765A	CHIMNEY CONNECTING PIPE KIT TB1765A1	<table border="1"> <thead> <tr> <th><i>Code</i></th> <th><i>Description</i></th> <th><i>Qty</i></th> <th><i>UOM</i></th> </tr> </thead> <tbody> <tr> <td>TB1765A1</td> <td>STACKING KIT CHIMNEY CONNECTING PIPE</td> <td>1.000</td> <td>PC</td> </tr> </tbody> </table>	<i>Code</i>	<i>Description</i>	<i>Qty</i>	<i>UOM</i>	TB1765A1	STACKING KIT CHIMNEY CONNECTING PIPE	1.000	PC
<i>Code</i>	<i>Description</i>	<i>Qty</i>	<i>UOM</i>										
TB1765A1	STACKING KIT CHIMNEY CONNECTING PIPE	1.000	PC										



ASM1668A/0.D01 - General overview

FRONT

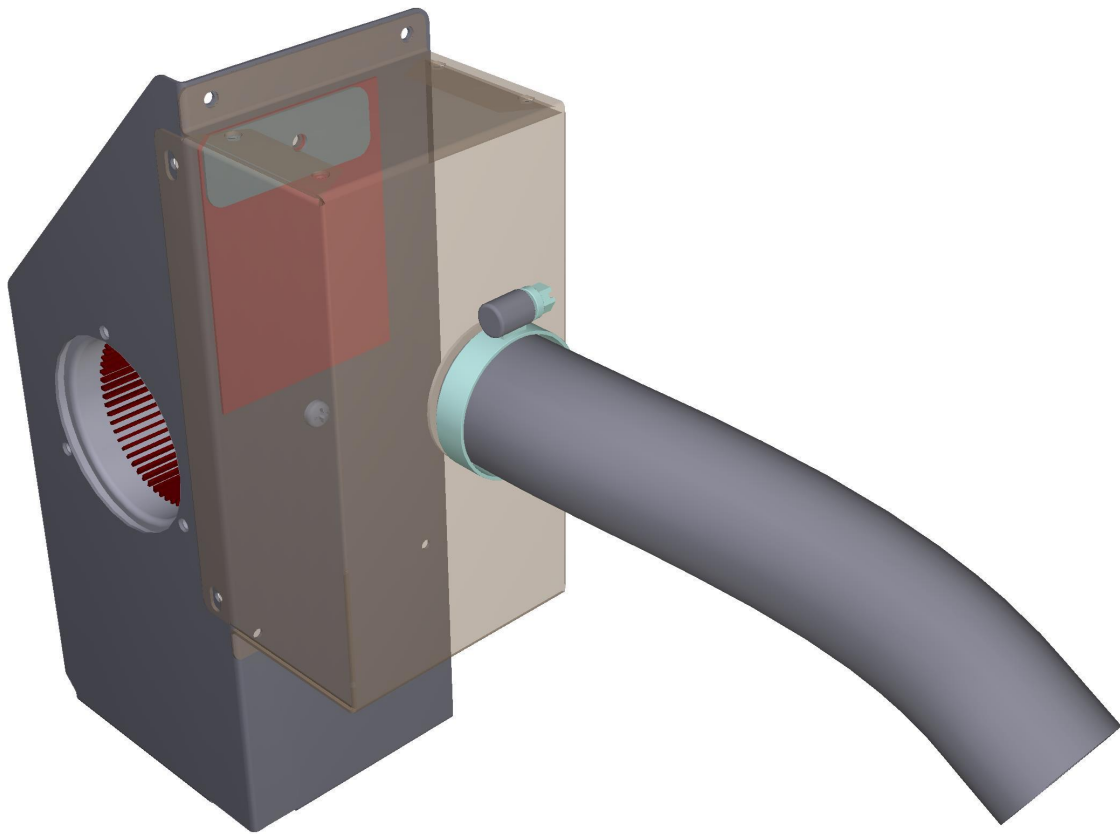

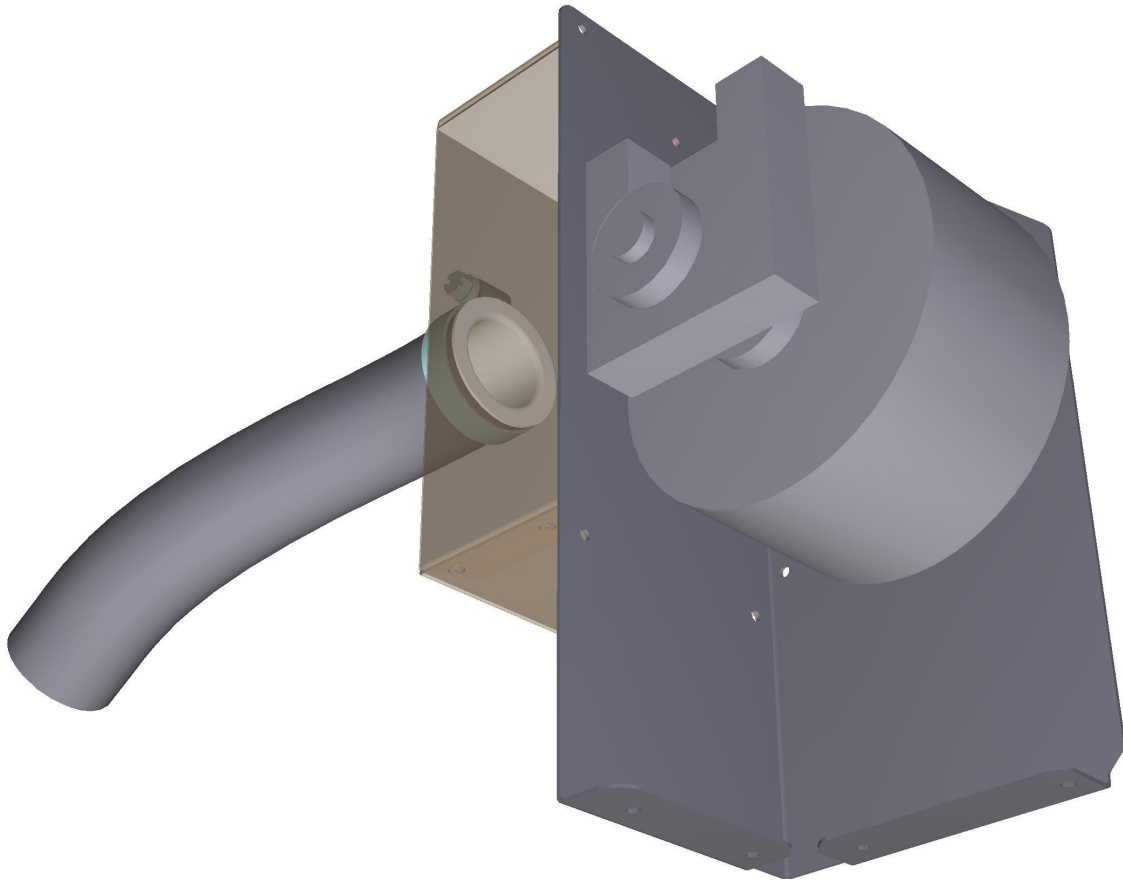

ASM1668A/0.D01 - General overview

REAR





COMPONENT			SPARE PART										
Code	Description	Image	Code	Description	Kit components								
0H6620A	DECKTOP FAN HOLDER		0H6620A0	DECKTOP FAN HOLDER									
0H6621A	XB262 DECK OVEN FAN BOX		0H6621A0	XB262 DECK OVEN FAN BOX									
0H6622A	XB262 DECK OVEN FLAP PRESS		0H6622A0	XB262 DECK OVEN FLAP PRESS									
GN1419A	DECK OVEN VENTURI FLAP		GN1419A0	DECK OVEN VENTURI FLAP									
MT1015A	DECK TOP CENTRIFUGAL FAN		KMT1015A	DECK OVEN FAN MOTOR KIT	<table border="1"> <thead> <tr> <th>Code</th> <th>Description</th> <th>Qty</th> <th>UOM</th> </tr> </thead> <tbody> <tr> <td>MT1015A1</td> <td>DECK OVEN CENTRIFUGAL FAN</td> <td>1.000</td> <td>PC</td> </tr> </tbody> </table>	Code	Description	Qty	UOM	MT1015A1	DECK OVEN CENTRIFUGAL FAN	1.000	PC
Code	Description	Qty	UOM										
MT1015A1	DECK OVEN CENTRIFUGAL FAN	1.000	PC										

COMPONENT			SPARE PART																			
Code	Description	Image	Code	Description	Kit components																	
RC1378A	HOSE CLAMP		KVM2379A	MM 200V VENTURI ACTUATOR SYSTEM KIT	<table border="1"> <thead> <tr> <th>Code</th> <th>Description</th> <th>Qty</th> <th>UOM</th> </tr> </thead> <tbody> <tr> <td>RC1378A0</td> <td>HOSE CLAMP</td> <td>3.000</td> <td>PC</td> </tr> <tr> <td>TB1520A0</td> <td>Int. Ø=38 TH=4 DRAIN BLACK RUBBER PIPE</td> <td>0.120</td> <td>M</td> </tr> <tr> <td>VM2379A1</td> <td></td> <td>1.000</td> <td>PC</td> </tr> </tbody> </table>	Code	Description	Qty	UOM	RC1378A0	HOSE CLAMP	3.000	PC	TB1520A0	Int. Ø=38 TH=4 DRAIN BLACK RUBBER PIPE	0.120	M	VM2379A1		1.000	PC	
			Code	Description	Qty	UOM																
			RC1378A0	HOSE CLAMP	3.000	PC																
			TB1520A0	Int. Ø=38 TH=4 DRAIN BLACK RUBBER PIPE	0.120	M																
			VM2379A1		1.000	PC																
KVM2378A	MM 240V VENTURI ACTUATOR SYSTEM KIT	<table border="1"> <thead> <tr> <th>Code</th> <th>Description</th> <th>Qty</th> <th>UOM</th> </tr> </thead> <tbody> <tr> <td>RC1378A0</td> <td>HOSE CLAMP</td> <td>3.000</td> <td>PC</td> </tr> <tr> <td>TB1520A0</td> <td>Int. Ø=38 TH=4 DRAIN BLACK RUBBER PIPE</td> <td>0.120</td> <td>M</td> </tr> <tr> <td>VM2378A1</td> <td></td> <td>1.000</td> <td>PC</td> </tr> </tbody> </table>	Code	Description	Qty	UOM	RC1378A0	HOSE CLAMP	3.000	PC	TB1520A0	Int. Ø=38 TH=4 DRAIN BLACK RUBBER PIPE	0.120	M	VM2378A1		1.000	PC				
Code	Description	Qty	UOM																			
RC1378A0	HOSE CLAMP	3.000	PC																			
TB1520A0	Int. Ø=38 TH=4 DRAIN BLACK RUBBER PIPE	0.120	M																			
VM2378A1		1.000	PC																			
KVM2377A	MM 220 V VENTURI ACTUATOR SYSTEM KIT	<table border="1"> <thead> <tr> <th>Code</th> <th>Description</th> <th>Qty</th> <th>UOM</th> </tr> </thead> <tbody> <tr> <td>RC1378A0</td> <td>HOSE CLAMP</td> <td>3.000</td> <td>PC</td> </tr> <tr> <td>TB1520A0</td> <td>Int. Ø=38 TH=4 DRAIN BLACK RUBBER PIPE</td> <td>0.120</td> <td>M</td> </tr> <tr> <td>VM2377A1</td> <td>220 V 50/60 HZ EUR VENTURI SET</td> <td>1.000</td> <td>PC</td> </tr> </tbody> </table>	Code	Description	Qty	UOM	RC1378A0	HOSE CLAMP	3.000	PC	TB1520A0	Int. Ø=38 TH=4 DRAIN BLACK RUBBER PIPE	0.120	M	VM2377A1	220 V 50/60 HZ EUR VENTURI SET	1.000	PC				
Code	Description	Qty	UOM																			
RC1378A0	HOSE CLAMP	3.000	PC																			
TB1520A0	Int. Ø=38 TH=4 DRAIN BLACK RUBBER PIPE	0.120	M																			
VM2377A1	220 V 50/60 HZ EUR VENTURI SET	1.000	PC																			
KVE1140A	S.5/5E JAPAN VERSION VENTURI COIL KIT	<table border="1"> <thead> <tr> <th>Code</th> <th>Description</th> <th>Qty</th> <th>UOM</th> </tr> </thead> <tbody> <tr> <td>RC1378A0</td> <td>HOSE CLAMP</td> <td>2.000</td> <td>PC</td> </tr> <tr> <td>TB1520A0</td> <td>Int. Ø=38 TH=4 DRAIN BLACK RUBBER PIPE</td> <td>0.050</td> <td>M</td> </tr> <tr> <td>VI1220A1</td> <td>4,2x12 TCB SELF-TAPPIN G SCREW</td> <td>1.000</td> <td>PC</td> </tr> <tr> <td>VM2632A0</td> <td></td> <td>1.000</td> <td>PC</td> </tr> </tbody> </table>	Code	Description	Qty	UOM	RC1378A0	HOSE CLAMP	2.000	PC	TB1520A0	Int. Ø=38 TH=4 DRAIN BLACK RUBBER PIPE	0.050	M	VI1220A1	4,2x12 TCB SELF-TAPPIN G SCREW	1.000	PC	VM2632A0		1.000	PC
Code	Description	Qty	UOM																			
RC1378A0	HOSE CLAMP	2.000	PC																			
TB1520A0	Int. Ø=38 TH=4 DRAIN BLACK RUBBER PIPE	0.050	M																			
VI1220A1	4,2x12 TCB SELF-TAPPIN G SCREW	1.000	PC																			
VM2632A0		1.000	PC																			
KVE1014A	US VERSION SERIES 5 VENTURI COIL KIT	<table border="1"> <thead> <tr> <th>Code</th> <th>Description</th> <th>Qty</th> <th>UOM</th> </tr> </thead> <tbody> <tr> <td>RC1378A0</td> <td>HOSE CLAMP</td> <td>2.000</td> <td>PC</td> </tr> <tr> <td>TB1520A0</td> <td>Int. Ø=38 TH=4 DRAIN BLACK RUBBER PIPE</td> <td>0.050</td> <td>M</td> </tr> <tr> <td>VM2633A0</td> <td></td> <td>1.000</td> <td>PC</td> </tr> </tbody> </table>	Code	Description	Qty	UOM	RC1378A0	HOSE CLAMP	2.000	PC	TB1520A0	Int. Ø=38 TH=4 DRAIN BLACK RUBBER PIPE	0.050	M	VM2633A0		1.000	PC				
Code	Description	Qty	UOM																			
RC1378A0	HOSE CLAMP	2.000	PC																			
TB1520A0	Int. Ø=38 TH=4 DRAIN BLACK RUBBER PIPE	0.050	M																			
VM2633A0		1.000	PC																			
KRC1378A	HOSE CLAMP 10 PCS KIT	<table border="1"> <thead> <tr> <th>Code</th> <th>Description</th> <th>Qty</th> <th>UOM</th> </tr> </thead> <tbody> <tr> <td>RC1378A0</td> <td>HOSE CLAMP</td> <td>10.000</td> <td>PC</td> </tr> </tbody> </table>	Code	Description	Qty	UOM	RC1378A0	HOSE CLAMP	10.000	PC												
Code	Description	Qty	UOM																			
RC1378A0	HOSE CLAMP	10.000	PC																			
TB1292A	PIPE CONNECTION VENTURI DECK TOP		TB1292A0	PIPE CONNECTION VENTURI DECK TOP																		



ASM4038C/0.D00 - External cover

FRONT

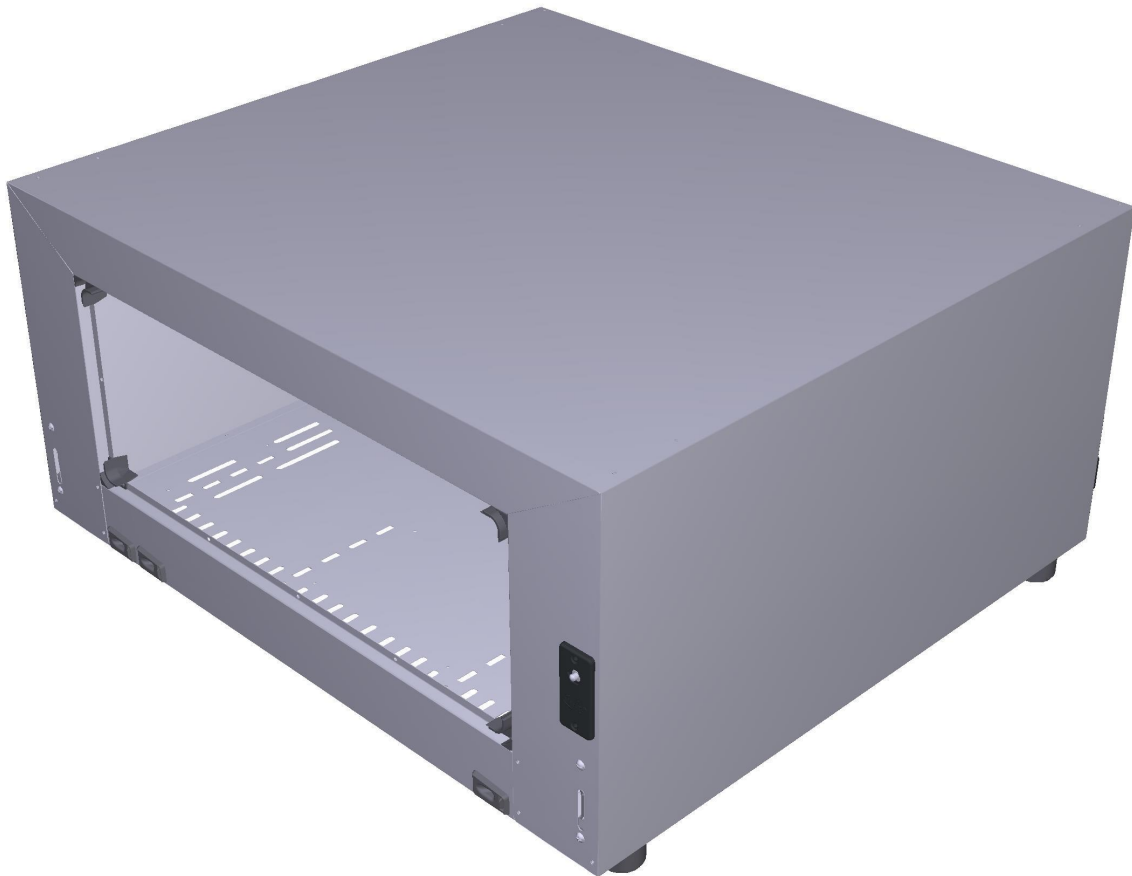

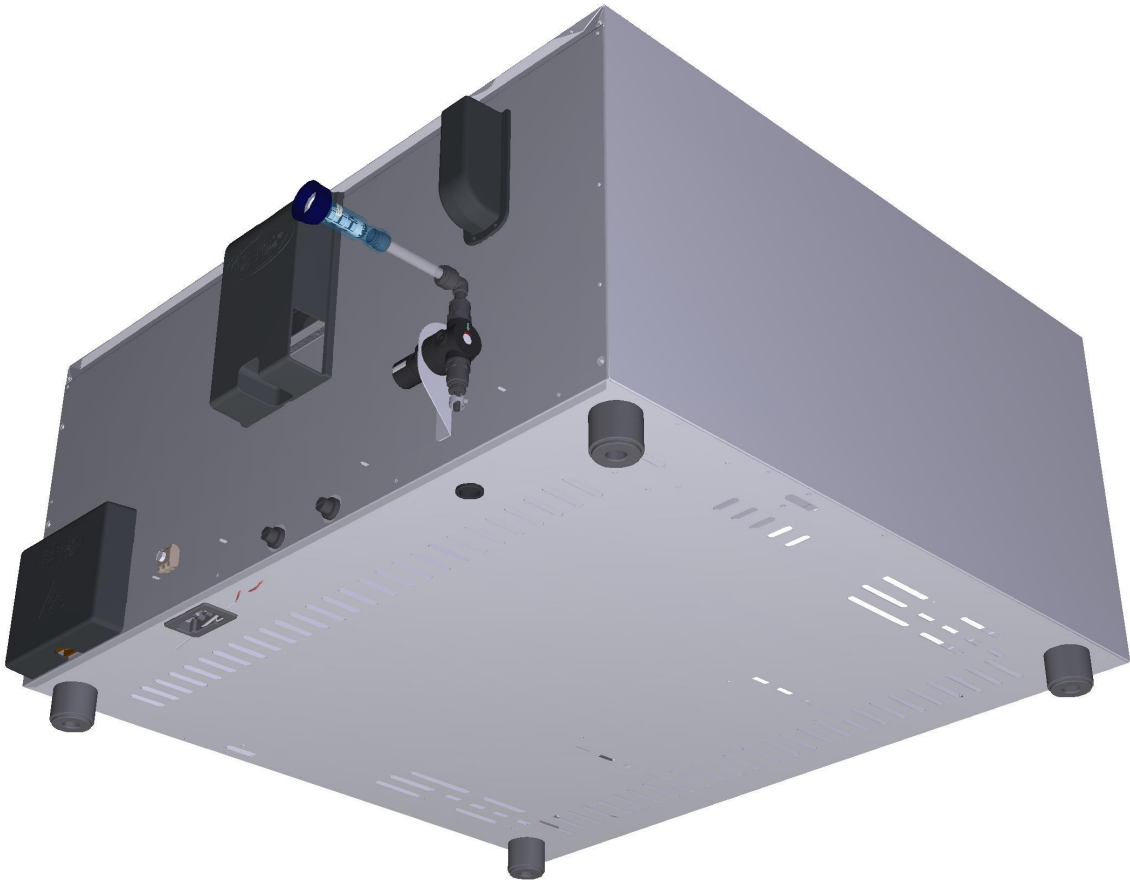

ASM4038C/0.D00 - External cover

REAR





COMPONENT			SPARE PART										
Code	Description	Image	Code	Description	Kit components								
0D2349B	CONTROLLED DECKTOP 1EU EXTERNAL CASING		0D2349B0	CONTROLLED DECKTOP 1EU EXTERNAL CASING									
0F1517A	DECKOVEN BACK PANEL		0F1517A0	DECKOVEN BACK PANEL									
VE1295A	MK 16A 230V DOOR MICROSWITCH		KVE1295A	16A 230V DOOR MICROSWITCH KIT	<table border="1"> <thead> <tr> <th>Code</th> <th>Description</th> <th>Qty</th> <th>UOM</th> </tr> </thead> <tbody> <tr> <td>VE1295A0</td> <td>MK 16A 230V DOOR MICROSWITC</td> <td>1.000</td> <td>PC</td> </tr> </tbody> </table>	Code	Description	Qty	UOM	VE1295A0	MK 16A 230V DOOR MICROSWITC	1.000	PC
Code	Description	Qty	UOM										
VE1295A0	MK 16A 230V DOOR MICROSWITC	1.000	PC										
VM1200A	DOOR MECHANIC MICROSWITCH SUPPORT PLATE		VM1200A0	DOOR MECHANIC MICROSWITCH SUPPORT PLATE									
0H8039A	MM COMPACT REDUCER SUPPORT PLATE		0H8039A0	MM COMPACT REDUCER SUPPORT PLATE									

COMPONENT			SPARE PART																						
Code	Description	Image	Code	Description	Kit components																				
RC1396A	JG D10-1/4 STRAIGHT END FITTING		KVL0014B	≥2017 MIND.MAPS PRESSURE REDUCER KIT	<table border="1"> <thead> <tr> <th>Code</th> <th>Description</th> <th>Qty</th> <th>UOM</th> </tr> </thead> <tbody> <tr> <td>RC1372A0</td> <td>Ø10M-1/4 M CIL. STRAIGHT FITTING</td> <td>1.000</td> <td>PC</td> </tr> <tr> <td>RC1396A0</td> <td>JG D10-1/4 STRAIGHT END FITTING</td> <td>1.000</td> <td>PC</td> </tr> <tr> <td>VL1014B2</td> <td>PRESSURE REDUCER WITH DISTRIBUTOR</td> <td>1.000</td> <td>PC</td> </tr> <tr> <td>VM1054A0</td> <td>H7.8 PRESSURE REDUCER RING NUT</td> <td>1.000</td> <td>PC</td> </tr> </tbody> </table>	Code	Description	Qty	UOM	RC1372A0	Ø10M-1/4 M CIL. STRAIGHT FITTING	1.000	PC	RC1396A0	JG D10-1/4 STRAIGHT END FITTING	1.000	PC	VL1014B2	PRESSURE REDUCER WITH DISTRIBUTOR	1.000	PC	VM1054A0	H7.8 PRESSURE REDUCER RING NUT	1.000	PC
Code	Description	Qty	UOM																						
RC1372A0	Ø10M-1/4 M CIL. STRAIGHT FITTING	1.000	PC																						
RC1396A0	JG D10-1/4 STRAIGHT END FITTING	1.000	PC																						
VL1014B2	PRESSURE REDUCER WITH DISTRIBUTOR	1.000	PC																						
VM1054A0	H7.8 PRESSURE REDUCER RING NUT	1.000	PC																						
VL1014B	PRESSURE REDUCER WITH DISTRIBUTOR		KVL0020A	PRESS.REDUCER 03-05XX≥OCT18/MM -LUX≥MAR19	<table border="1"> <thead> <tr> <th>Code</th> <th>Description</th> <th>Qty</th> <th>UOM</th> </tr> </thead> <tbody> <tr> <td>RC1396A0</td> <td>JG D10-1/4 STRAIGHT END FITTING</td> <td>2.000</td> <td>PC</td> </tr> <tr> <td>VL1014B2</td> <td>PRESSURE REDUCER WITH DISTRIBUTOR</td> <td>1.000</td> <td>PC</td> </tr> <tr> <td>VM1054A0</td> <td>H7.8 PRESSURE REDUCER RING NUT</td> <td>1.000</td> <td>PC</td> </tr> </tbody> </table>	Code	Description	Qty	UOM	RC1396A0	JG D10-1/4 STRAIGHT END FITTING	2.000	PC	VL1014B2	PRESSURE REDUCER WITH DISTRIBUTOR	1.000	PC	VM1054A0	H7.8 PRESSURE REDUCER RING NUT	1.000	PC				
Code	Description	Qty	UOM																						
RC1396A0	JG D10-1/4 STRAIGHT END FITTING	2.000	PC																						
VL1014B2	PRESSURE REDUCER WITH DISTRIBUTOR	1.000	PC																						
VM1054A0	H7.8 PRESSURE REDUCER RING NUT	1.000	PC																						
			KVL0014B	≥2017 MIND.MAPS PRESSURE REDUCER KIT	<table border="1"> <thead> <tr> <th>Code</th> <th>Description</th> <th>Qty</th> <th>UOM</th> </tr> </thead> <tbody> <tr> <td>RC1372A0</td> <td>Ø10M-1/4 M CIL. STRAIGHT FITTING</td> <td>1.000</td> <td>PC</td> </tr> <tr> <td>RC1396A0</td> <td>JG D10-1/4 STRAIGHT END FITTING</td> <td>1.000</td> <td>PC</td> </tr> <tr> <td>VL1014B2</td> <td>PRESSURE REDUCER WITH DISTRIBUTOR</td> <td>1.000</td> <td>PC</td> </tr> <tr> <td>VM1054A0</td> <td>H7.8 PRESSURE REDUCER RING NUT</td> <td>1.000</td> <td>PC</td> </tr> </tbody> </table>	Code	Description	Qty	UOM	RC1372A0	Ø10M-1/4 M CIL. STRAIGHT FITTING	1.000	PC	RC1396A0	JG D10-1/4 STRAIGHT END FITTING	1.000	PC	VL1014B2	PRESSURE REDUCER WITH DISTRIBUTOR	1.000	PC	VM1054A0	H7.8 PRESSURE REDUCER RING NUT	1.000	PC
Code	Description	Qty	UOM																						
RC1372A0	Ø10M-1/4 M CIL. STRAIGHT FITTING	1.000	PC																						
RC1396A0	JG D10-1/4 STRAIGHT END FITTING	1.000	PC																						
VL1014B2	PRESSURE REDUCER WITH DISTRIBUTOR	1.000	PC																						
VM1054A0	H7.8 PRESSURE REDUCER RING NUT	1.000	PC																						
			KVL0014A	MM ≤2016 / LUX<2019 PRESSURE REDUCER KIT	<table border="1"> <thead> <tr> <th>Code</th> <th>Description</th> <th>Qty</th> <th>UOM</th> </tr> </thead> <tbody> <tr> <td>RC1372A0</td> <td>Ø10M-1/4 M CIL. STRAIGHT FITTING</td> <td>2.000</td> <td>PC</td> </tr> <tr> <td>VL1014B2</td> <td>PRESSURE REDUCER WITH DISTRIBUTOR</td> <td>1.000</td> <td>PC</td> </tr> <tr> <td>VM1054A0</td> <td>H7.8 PRESSURE REDUCER RING NUT</td> <td>1.000</td> <td>PC</td> </tr> </tbody> </table>	Code	Description	Qty	UOM	RC1372A0	Ø10M-1/4 M CIL. STRAIGHT FITTING	2.000	PC	VL1014B2	PRESSURE REDUCER WITH DISTRIBUTOR	1.000	PC	VM1054A0	H7.8 PRESSURE REDUCER RING NUT	1.000	PC				
Code	Description	Qty	UOM																						
RC1372A0	Ø10M-1/4 M CIL. STRAIGHT FITTING	2.000	PC																						
VL1014B2	PRESSURE REDUCER WITH DISTRIBUTOR	1.000	PC																						
VM1054A0	H7.8 PRESSURE REDUCER RING NUT	1.000	PC																						







COMPONENT			SPARE PART																																										
Code	Description	Image	Code	Description	Kit components																																								
VL1014B	PRESSURE REDUCER WITH DISTRIBUTOR		KVL0010A	S.4 - 5 WATER PRESSURE REDUCER KIT	<table border="1"> <thead> <tr> <th>Code</th> <th>Description</th> <th>Qty</th> <th>UOM</th> </tr> </thead> <tbody> <tr> <td>EL1210A0</td> <td>D8-BSP1/4 JG STRAIGHT END CONNECTION</td> <td>2.000</td> <td>PC</td> </tr> </tbody> </table>	Code	Description	Qty	UOM	EL1210A0	D8-BSP1/4 JG STRAIGHT END CONNECTION	2.000	PC																																
					Code	Description	Qty	UOM																																					
EL1210A0	D8-BSP1/4 JG STRAIGHT END CONNECTION	2.000	PC																																										
<table border="1"> <tbody> <tr> <td>VL1014B2</td> <td>PRESSURE REDUCER WITH DISTRIBUTOR</td> <td>1.000</td> <td>PC</td> </tr> </tbody> </table>	VL1014B2	PRESSURE REDUCER WITH DISTRIBUTOR	1.000	PC																																									
VL1014B2	PRESSURE REDUCER WITH DISTRIBUTOR	1.000	PC																																										
VM1054A	H7.8 PRESSURE REDUCER RING NUT		KVM1054A	H7.8 PRESSURE REDUCER DIAL KIT	<table border="1"> <thead> <tr> <th>Code</th> <th>Description</th> <th>Qty</th> <th>UOM</th> </tr> </thead> <tbody> <tr> <td>VM1054A0</td> <td>H7.8 PRESSURE REDUCER RING NUT</td> <td>1.000</td> <td>PC</td> </tr> </tbody> </table>	Code	Description	Qty	UOM	VM1054A0	H7.8 PRESSURE REDUCER RING NUT	1.000	PC																																
					Code	Description	Qty	UOM																																					
			VM1054A0	H7.8 PRESSURE REDUCER RING NUT	1.000	PC																																							
			KVL1117A	EUR MM 2016+LMT FILTER+PRESS. RED. KIT	<table border="1"> <thead> <tr> <th>Code</th> <th>Description</th> <th>Qty</th> <th>UOM</th> </tr> </thead> <tbody> <tr> <td>0H7472A1</td> <td>DISTRIBUTOR SUPPORT PLATE</td> <td>1.000</td> <td>PC</td> </tr> <tr> <td>RC1004A0</td> <td>Ø10-Ø8-8 Y CONNECTION</td> <td>1.000</td> <td>PC</td> </tr> <tr> <td>RC1243A0</td> <td>Ø10F-Ø10M ELBOW CONNECTION + JG END KIT</td> <td>1.000</td> <td>PC</td> </tr> <tr> <td>RC1372A0</td> <td>Ø10M-1/4 M CIL. STRAIGHT FITTING</td> <td>2.000</td> <td>PC</td> </tr> <tr> <td>VI1220A1</td> <td>4,2x12 TCB SELF-TAPPING SCREW</td> <td>4.000</td> <td>PC</td> </tr> <tr> <td>VL1014B2</td> <td>PRESSURE REDUCER WITH DISTRIBUTOR</td> <td>1.000</td> <td>PC</td> </tr> <tr> <td>VL1034C0</td> <td>MESH WATER FILTER D10</td> <td>1.000</td> <td>PC</td> </tr> <tr> <td>VL1062C0</td> <td>PRESSURE REDUCER-FILTER LOCKING FORK</td> <td>1.000</td> <td>PC</td> </tr> <tr> <td>VM1054A0</td> <td>H7.8 PRESSURE REDUCER RING NUT</td> <td>1.000</td> <td>PC</td> </tr> </tbody> </table>	Code	Description	Qty	UOM	0H7472A1	DISTRIBUTOR SUPPORT PLATE	1.000	PC	RC1004A0	Ø10-Ø8-8 Y CONNECTION	1.000	PC	RC1243A0	Ø10F-Ø10M ELBOW CONNECTION + JG END KIT	1.000	PC	RC1372A0	Ø10M-1/4 M CIL. STRAIGHT FITTING	2.000	PC	VI1220A1	4,2x12 TCB SELF-TAPPING SCREW	4.000	PC	VL1014B2	PRESSURE REDUCER WITH DISTRIBUTOR	1.000	PC	VL1034C0	MESH WATER FILTER D10	1.000	PC	VL1062C0	PRESSURE REDUCER-FILTER LOCKING FORK	1.000	PC	VM1054A0	H7.8 PRESSURE REDUCER RING NUT	1.000	PC
					Code	Description	Qty	UOM																																					
					0H7472A1	DISTRIBUTOR SUPPORT PLATE	1.000	PC																																					
					RC1004A0	Ø10-Ø8-8 Y CONNECTION	1.000	PC																																					
					RC1243A0	Ø10F-Ø10M ELBOW CONNECTION + JG END KIT	1.000	PC																																					
					RC1372A0	Ø10M-1/4 M CIL. STRAIGHT FITTING	2.000	PC																																					
					VI1220A1	4,2x12 TCB SELF-TAPPING SCREW	4.000	PC																																					
					VL1014B2	PRESSURE REDUCER WITH DISTRIBUTOR	1.000	PC																																					
					VL1034C0	MESH WATER FILTER D10	1.000	PC																																					
					VL1062C0	PRESSURE REDUCER-FILTER LOCKING FORK	1.000	PC																																					
					VM1054A0	H7.8 PRESSURE REDUCER RING NUT	1.000	PC																																					

COMPONENT			SPARE PART																																																		
Code	Description	Image	Code	Description	Kit components																																																
RC1243A	Ø10F-Ø10M ELBOW CONNECTION + JG END KIT		KVL1163A	MINDMAPS INLET CONNECTING PIPE KIT	<table border="1"> <thead> <tr> <th>Code</th> <th>Description</th> <th>Qty</th> <th>UOM</th> </tr> </thead> <tbody> <tr> <td>0H8038A0</td> <td>MM REDUCER SUPPORT PLATE</td> <td>1.000</td> <td>PC</td> </tr> <tr> <td>0H8039A0</td> <td>MM COMPACT REDUCER SUPPORT PLATE</td> <td>1.000</td> <td>PC</td> </tr> <tr> <td>CH1026A0</td> <td>UNOX JOHN GUEST SPANNER D8-D10</td> <td>1.000</td> <td>PC</td> </tr> <tr> <td>RC1243A0</td> <td>Ø10F-Ø10M ELBOW CONNECTION + JG END KIT</td> <td>2.000</td> <td>PC</td> </tr> <tr> <td>RC1396A0</td> <td>JG D10-1/4 STRAIGHT END FITTING</td> <td>2.000</td> <td>PC</td> </tr> <tr> <td>TB2243A0</td> <td>D10 PE TRANSPAREN T PIPE</td> <td>1.500</td> <td>M</td> </tr> <tr> <td>VI1220A1</td> <td>4,2x12 TCB SELF-TAPPIN G SCREW</td> <td>2.000</td> <td>PC</td> </tr> <tr> <td>VI1950A0</td> <td>ST. STEEL 4,2X13 TCB SELF-DRILLIN G SCREW</td> <td>1.000</td> <td>PC</td> </tr> <tr> <td>VL1014B2</td> <td>PRESSURE REDUCER WITH DISTRIBUTOR</td> <td>1.000</td> <td>PC</td> </tr> <tr> <td>VL1135A1</td> <td>3/4-JG10 CONNECTOR + FILTER AND NRV</td> <td>1.000</td> <td>PC</td> </tr> <tr> <td>VM1054A0</td> <td>H7.8 PRESSURE REDUCER RING NUT</td> <td>1.000</td> <td>PC</td> </tr> </tbody> </table>	Code	Description	Qty	UOM	0H8038A0	MM REDUCER SUPPORT PLATE	1.000	PC	0H8039A0	MM COMPACT REDUCER SUPPORT PLATE	1.000	PC	CH1026A0	UNOX JOHN GUEST SPANNER D8-D10	1.000	PC	RC1243A0	Ø10F-Ø10M ELBOW CONNECTION + JG END KIT	2.000	PC	RC1396A0	JG D10-1/4 STRAIGHT END FITTING	2.000	PC	TB2243A0	D10 PE TRANSPAREN T PIPE	1.500	M	VI1220A1	4,2x12 TCB SELF-TAPPIN G SCREW	2.000	PC	VI1950A0	ST. STEEL 4,2X13 TCB SELF-DRILLIN G SCREW	1.000	PC	VL1014B2	PRESSURE REDUCER WITH DISTRIBUTOR	1.000	PC	VL1135A1	3/4-JG10 CONNECTOR + FILTER AND NRV	1.000	PC	VM1054A0	H7.8 PRESSURE REDUCER RING NUT	1.000	PC
			Code	Description	Qty	UOM																																															
0H8038A0	MM REDUCER SUPPORT PLATE	1.000	PC																																																		
0H8039A0	MM COMPACT REDUCER SUPPORT PLATE	1.000	PC																																																		
CH1026A0	UNOX JOHN GUEST SPANNER D8-D10	1.000	PC																																																		
RC1243A0	Ø10F-Ø10M ELBOW CONNECTION + JG END KIT	2.000	PC																																																		
RC1396A0	JG D10-1/4 STRAIGHT END FITTING	2.000	PC																																																		
TB2243A0	D10 PE TRANSPAREN T PIPE	1.500	M																																																		
VI1220A1	4,2x12 TCB SELF-TAPPIN G SCREW	2.000	PC																																																		
VI1950A0	ST. STEEL 4,2X13 TCB SELF-DRILLIN G SCREW	1.000	PC																																																		
VL1014B2	PRESSURE REDUCER WITH DISTRIBUTOR	1.000	PC																																																		
VL1135A1	3/4-JG10 CONNECTOR + FILTER AND NRV	1.000	PC																																																		
VM1054A0	H7.8 PRESSURE REDUCER RING NUT	1.000	PC																																																		
KRC1243A	Ø10F-Ø10M ELBOW CONN + JG END 10 PCS KIT	<table border="1"> <thead> <tr> <th>Code</th> <th>Description</th> <th>Qty</th> <th>UOM</th> </tr> </thead> <tbody> <tr> <td>RC1243A0</td> <td>Ø10F-Ø10M ELBOW CONNECTION + JG END KIT</td> <td>10.000</td> <td>PC</td> </tr> </tbody> </table>	Code	Description	Qty	UOM	RC1243A0	Ø10F-Ø10M ELBOW CONNECTION + JG END KIT	10.000	PC																																											
Code	Description	Qty	UOM																																																		
RC1243A0	Ø10F-Ø10M ELBOW CONNECTION + JG END KIT	10.000	PC																																																		



COMPONENT			SPARE PART																		
Code	Description	Image	Code	Description	Kit components																
TB1099A	TB3130A-D10 WATER CONNECTING PIPE		KTB2599A	Ø10 PET WATER PIPE TB2243A0 100M KIT	<table border="1"> <thead> <tr> <th>Code</th> <th>Description</th> <th>Qty</th> <th>UOM</th> </tr> </thead> <tbody> <tr> <td>TB2243A0</td> <td>D10 PE TRANSPARENT PIPE</td> <td>100.000</td> <td>M</td> </tr> </tbody> </table>	Code	Description	Qty	UOM	TB2243A0	D10 PE TRANSPARENT PIPE	100.000	M								
			Code	Description	Qty	UOM															
TB2243A0	D10 PE TRANSPARENT PIPE	100.000	M																		
KTB2598A	D10 PET HUMIDITY PIPE TB2243A0 3 M KIT	<table border="1"> <thead> <tr> <th>Code</th> <th>Description</th> <th>Qty</th> <th>UOM</th> </tr> </thead> <tbody> <tr> <td>TB2243A0</td> <td>D10 PE TRANSPARENT PIPE</td> <td>3.000</td> <td>M</td> </tr> </tbody> </table>	Code	Description	Qty	UOM	TB2243A0	D10 PE TRANSPARENT PIPE	3.000	M											
Code	Description	Qty	UOM																		
TB2243A0	D10 PE TRANSPARENT PIPE	3.000	M																		
VL1135A	3/4-JG10 CONNECTOR + FILTER AND NRV		KVL1135A	3/4-JG10 FITTING WITH FILTER AND VNR KIT	<table border="1"> <thead> <tr> <th>Code</th> <th>Description</th> <th>Qty</th> <th>UOM</th> </tr> </thead> <tbody> <tr> <td>RC1360A0</td> <td>10 - 10 JG ELBOW FITTING</td> <td>1.000</td> <td>PC</td> </tr> <tr> <td>VL1135A1</td> <td>3/4-JG10 CONNECTOR + FILTER AND NRV</td> <td>1.000</td> <td>PC</td> </tr> </tbody> </table>	Code	Description	Qty	UOM	RC1360A0	10 - 10 JG ELBOW FITTING	1.000	PC	VL1135A1	3/4-JG10 CONNECTOR + FILTER AND NRV	1.000	PC				
Code	Description	Qty	UOM																		
RC1360A0	10 - 10 JG ELBOW FITTING	1.000	PC																		
VL1135A1	3/4-JG10 CONNECTOR + FILTER AND NRV	1.000	PC																		
VL1095A	D7.8-D10 RUBBER HOLDER M-M FITTING		KVL1095A	STRAIGHT CONNECT-HOLDER D7-D10 10PCS KIT	<table border="1"> <thead> <tr> <th>Code</th> <th>Description</th> <th>Qty</th> <th>UOM</th> </tr> </thead> <tbody> <tr> <td>VL1095A0</td> <td>D7.8-D10 RUBBER HOLDER M-M FITTING</td> <td>10.000</td> <td>PC</td> </tr> </tbody> </table>	Code	Description	Qty	UOM	VL1095A0	D7.8-D10 RUBBER HOLDER M-M FITTING	10.000	PC								
Code	Description	Qty	UOM																		
VL1095A0	D7.8-D10 RUBBER HOLDER M-M FITTING	10.000	PC																		
VM1555A	CT BT COOLING FAN SUPPORT		KVN1165A	S.5E ADVANCE/MM 230V COOLING FAN KIT	<table border="1"> <thead> <tr> <th>Code</th> <th>Description</th> <th>Qty</th> <th>UOM</th> </tr> </thead> <tbody> <tr> <td>VI1099A0</td> <td>SELF-DRILLING SCREW 4.8X13 TCB+ Z</td> <td>4.000</td> <td>PC</td> </tr> <tr> <td>VM1555A2</td> <td>CT BT COOLING FAN SUPPORT</td> <td>1.000</td> <td>PC</td> </tr> <tr> <td>VN1165A0</td> <td>230Vac 50/60Hz COOLING DOWN FAN</td> <td>1.000</td> <td>PC</td> </tr> </tbody> </table>	Code	Description	Qty	UOM	VI1099A0	SELF-DRILLING SCREW 4.8X13 TCB+ Z	4.000	PC	VM1555A2	CT BT COOLING FAN SUPPORT	1.000	PC	VN1165A0	230Vac 50/60Hz COOLING DOWN FAN	1.000	PC
					Code	Description	Qty	UOM													
			VI1099A0	SELF-DRILLING SCREW 4.8X13 TCB+ Z	4.000	PC															
			VM1555A2	CT BT COOLING FAN SUPPORT	1.000	PC															
VN1165A0	230Vac 50/60Hz COOLING DOWN FAN	1.000	PC																		
KVN1164A	S.5/5E 12VDC COOLING DOWN FAN KIT	<table border="1"> <thead> <tr> <th>Code</th> <th>Description</th> <th>Qty</th> <th>UOM</th> </tr> </thead> <tbody> <tr> <td>VI1099A0</td> <td>SELF-DRILLING SCREW 4.8X13 TCB+ Z</td> <td>4.000</td> <td>PC</td> </tr> <tr> <td>VM1555A2</td> <td>CT BT COOLING FAN SUPPORT</td> <td>1.000</td> <td>PC</td> </tr> <tr> <td>VN1164A0</td> <td>12VDC COOLING DOWN FAN</td> <td>1.000</td> <td>PC</td> </tr> </tbody> </table>	Code	Description	Qty	UOM	VI1099A0	SELF-DRILLING SCREW 4.8X13 TCB+ Z	4.000	PC	VM1555A2	CT BT COOLING FAN SUPPORT	1.000	PC	VN1164A0	12VDC COOLING DOWN FAN	1.000	PC			
		Code	Description	Qty	UOM																
VI1099A0	SELF-DRILLING SCREW 4.8X13 TCB+ Z	4.000	PC																		
VM1555A2	CT BT COOLING FAN SUPPORT	1.000	PC																		
VN1164A0	12VDC COOLING DOWN FAN	1.000	PC																		



COMPONENT			SPARE PART																										
Code	Description	Image	Code	Description	Kit components																								
VM1556A	XBC-XVC COOLING FAN GUARD		KVM1556A	XBC-XVC COOLING FAN GUARD KIT	<table border="1"> <thead> <tr> <th>Code</th> <th>Description</th> <th>Qty</th> <th>UOM</th> </tr> </thead> <tbody> <tr> <td>VM1556A0</td> <td>XBC-XVC COOLING FAN GUARD</td> <td>1.000</td> <td>PC</td> </tr> </tbody> </table>	Code	Description	Qty	UOM	VM1556A0	XBC-XVC COOLING FAN GUARD	1.000	PC																
Code	Description	Qty	UOM																										
VM1556A0	XBC-XVC COOLING FAN GUARD	1.000	PC																										
VN1165A	230Vac 50/60Hz COOLING DOWN FA		KVN1165A	S.5E ADVANCE/MM 230V COOLING FAN KIT	<table border="1"> <thead> <tr> <th>Code</th> <th>Description</th> <th>Qty</th> <th>UOM</th> </tr> </thead> <tbody> <tr> <td>V11099A0</td> <td>SELF-DRILLIN G SCREW 4.8X13 TCB+ Z</td> <td>4.000</td> <td>PC</td> </tr> <tr> <td>VM1555A2</td> <td>CT BT COOLING FAN SUPPORT</td> <td>1.000</td> <td>PC</td> </tr> <tr> <td>VN1165A0</td> <td>230Vac 50/60Hz COOLING DOWN FAN</td> <td>1.000</td> <td>PC</td> </tr> </tbody> </table>	Code	Description	Qty	UOM	V11099A0	SELF-DRILLIN G SCREW 4.8X13 TCB+ Z	4.000	PC	VM1555A2	CT BT COOLING FAN SUPPORT	1.000	PC	VN1165A0	230Vac 50/60Hz COOLING DOWN FAN	1.000	PC								
Code	Description	Qty	UOM																										
V11099A0	SELF-DRILLIN G SCREW 4.8X13 TCB+ Z	4.000	PC																										
VM1555A2	CT BT COOLING FAN SUPPORT	1.000	PC																										
VN1165A0	230Vac 50/60Hz COOLING DOWN FAN	1.000	PC																										
CR1000A	HINGE LATCH L.M.		KCR1000A	LM HINGES LATCH KIT	<table border="1"> <thead> <tr> <th>Code</th> <th>Description</th> <th>Qty</th> <th>UOM</th> </tr> </thead> <tbody> <tr> <td>CR1000A0</td> <td>HINGE LATCH L.M.</td> <td>1.000</td> <td>PC</td> </tr> <tr> <td>V11280A3</td> <td>M5x10 TC1/2T SCREW</td> <td>2.000</td> <td>PC</td> </tr> </tbody> </table>	Code	Description	Qty	UOM	CR1000A0	HINGE LATCH L.M.	1.000	PC	V11280A3	M5x10 TC1/2T SCREW	2.000	PC												
Code	Description	Qty	UOM																										
CR1000A0	HINGE LATCH L.M.	1.000	PC																										
V11280A3	M5x10 TC1/2T SCREW	2.000	PC																										
TR1136A	318°C -0/+24 1 POLE SAFETY THERMOSTAT		KTR1136A	318°C -0/+24 SAFETY THERMOSTAT KIT	<table border="1"> <thead> <tr> <th>Code</th> <th>Description</th> <th>Qty</th> <th>UOM</th> </tr> </thead> <tbody> <tr> <td>0H7030A0</td> <td>THERMOSTAT BULB INLET COVER</td> <td>1.000</td> <td>PC</td> </tr> <tr> <td>GN1531A0</td> <td>THERMOSTAT BULB INLET SEALING</td> <td>1.000</td> <td>PC</td> </tr> <tr> <td>SL1045A0</td> <td>S57 BLACK SILICONE - 80ml CARTRIDGE</td> <td>1.000</td> <td>PC</td> </tr> <tr> <td>TR1136A0</td> <td>318°C -0/+24 1 POLE SAFETY THERMOSTAT</td> <td>1.000</td> <td>PC</td> </tr> <tr> <td>V11220A1</td> <td>4,2x12 TCB SELF-TAPPIN G SCREW</td> <td>3.000</td> <td>PC</td> </tr> </tbody> </table>	Code	Description	Qty	UOM	0H7030A0	THERMOSTAT BULB INLET COVER	1.000	PC	GN1531A0	THERMOSTAT BULB INLET SEALING	1.000	PC	SL1045A0	S57 BLACK SILICONE - 80ml CARTRIDGE	1.000	PC	TR1136A0	318°C -0/+24 1 POLE SAFETY THERMOSTAT	1.000	PC	V11220A1	4,2x12 TCB SELF-TAPPIN G SCREW	3.000	PC
Code	Description	Qty	UOM																										
0H7030A0	THERMOSTAT BULB INLET COVER	1.000	PC																										
GN1531A0	THERMOSTAT BULB INLET SEALING	1.000	PC																										
SL1045A0	S57 BLACK SILICONE - 80ml CARTRIDGE	1.000	PC																										
TR1136A0	318°C -0/+24 1 POLE SAFETY THERMOSTAT	1.000	PC																										
V11220A1	4,2x12 TCB SELF-TAPPIN G SCREW	3.000	PC																										



COMPONENT			SPARE PART																						
Code	Description	Image	Code	Description	Kit components																				
VE1075A	STRAIN RELIEF PA6 UL94V2+ FIXING SCREWS		KVE1075A	PANEL WIRE CLAMP 10PCS KIT	<table border="1"> <thead> <tr> <th>Code</th> <th>Description</th> <th>Qty</th> <th>UOM</th> </tr> </thead> <tbody> <tr> <td>VE1075A0</td> <td>STRAIN RELIEF PA6 UL94V2+ FIXING SCREWS</td> <td>10.000</td> <td>PC</td> </tr> </tbody> </table>	Code	Description	Qty	UOM	VE1075A0	STRAIN RELIEF PA6 UL94V2+ FIXING SCREWS	10.000	PC												
Code	Description	Qty	UOM																						
VE1075A0	STRAIN RELIEF PA6 UL94V2+ FIXING SCREWS	10.000	PC																						
VM1225A	PLATE WITH HOLES FOR ELECTRONIC		VM1225A1	PLATE WITH HOLES FOR ELECTRONIC																					
VM1310A	COVER FOR XB/XV/XVC/XG TERMINAL BLOCK		VM1310A0	COVER FOR XB/XV/XVC/XG TERMINAL BLOCK																					
VM1505A	WALL PASSING WITH DIAPHRAGM		KVM1505A	THROUGH-WALL CONNECTION+DIAPHRAGM KIT	<table border="1"> <thead> <tr> <th>Code</th> <th>Description</th> <th>Qty</th> <th>UOM</th> </tr> </thead> <tbody> <tr> <td>VI1220A1</td> <td>4,2x12 TCB SELF-TAPPING SCREW</td> <td>1.000</td> <td>PC</td> </tr> <tr> <td>VM1505A0</td> <td>WALL PASSING WITH DIAPHRAGM</td> <td>3.000</td> <td>PC</td> </tr> <tr> <td>VM2055A0</td> <td>UPPER WALL PASSING ACCESSORY CABLES</td> <td>1.000</td> <td>PC</td> </tr> <tr> <td>VM2056A0</td> <td>LOWER WALL PASSING ACCESSORY CABLES</td> <td>1.000</td> <td>PC</td> </tr> </tbody> </table>	Code	Description	Qty	UOM	VI1220A1	4,2x12 TCB SELF-TAPPING SCREW	1.000	PC	VM1505A0	WALL PASSING WITH DIAPHRAGM	3.000	PC	VM2055A0	UPPER WALL PASSING ACCESSORY CABLES	1.000	PC	VM2056A0	LOWER WALL PASSING ACCESSORY CABLES	1.000	PC
Code	Description	Qty	UOM																						
VI1220A1	4,2x12 TCB SELF-TAPPING SCREW	1.000	PC																						
VM1505A0	WALL PASSING WITH DIAPHRAGM	3.000	PC																						
VM2055A0	UPPER WALL PASSING ACCESSORY CABLES	1.000	PC																						
VM2056A0	LOWER WALL PASSING ACCESSORY CABLES	1.000	PC																						



COMPONENT			SPARE PART																						
Code	Description	Image	Code	Description	Kit components																				
VM1750A	BRASS COMB CLAM		KVM1750A	COMB TERMINAL BLOCK KIT	<table border="1"> <thead> <tr> <th>Code</th> <th>Description</th> <th>Qty</th> <th>UOM</th> </tr> </thead> <tbody> <tr> <td>VI1040A0</td> <td>INDENTED INTERNAL WASHER D=6 ZN</td> <td>2.000</td> <td>PC</td> </tr> <tr> <td>VM1750A0</td> <td>BRASS COMB CLAMP</td> <td>1.000</td> <td>PC</td> </tr> </tbody> </table>	Code	Description	Qty	UOM	VI1040A0	INDENTED INTERNAL WASHER D=6 ZN	2.000	PC	VM1750A0	BRASS COMB CLAMP	1.000	PC								
Code	Description	Qty	UOM																						
VI1040A0	INDENTED INTERNAL WASHER D=6 ZN	2.000	PC																						
VM1750A0	BRASS COMB CLAMP	1.000	PC																						
VM1951A	CHIMNEY COVER		KVM1951A	EXHAUST CHIMNEY COVER KIT	<table border="1"> <thead> <tr> <th>Code</th> <th>Description</th> <th>Qty</th> <th>UOM</th> </tr> </thead> <tbody> <tr> <td>VI1220A1</td> <td>4,2x12 TCB SELF-TAPPIN G SCREW</td> <td>2.000</td> <td>PC</td> </tr> <tr> <td>VM1951A1</td> <td>CHIMNEY COVER</td> <td>1.000</td> <td>PC</td> </tr> </tbody> </table>	Code	Description	Qty	UOM	VI1220A1	4,2x12 TCB SELF-TAPPIN G SCREW	2.000	PC	VM1951A1	CHIMNEY COVER	1.000	PC								
Code	Description	Qty	UOM																						
VI1220A1	4,2x12 TCB SELF-TAPPIN G SCREW	2.000	PC																						
VM1951A1	CHIMNEY COVER	1.000	PC																						
VM1983A	R10 GASKET ANGLE		VM1983A0	R10 GASKET ANGLE																					
VM2061A	ACCESSORIES CABLES WALL PASSING		KVM1505A	THROUGH-WALL CONNECTION+DIAPHRAGM KIT	<table border="1"> <thead> <tr> <th>Code</th> <th>Description</th> <th>Qty</th> <th>UOM</th> </tr> </thead> <tbody> <tr> <td>VI1220A1</td> <td>4,2x12 TCB SELF-TAPPIN G SCREW</td> <td>1.000</td> <td>PC</td> </tr> <tr> <td>VM1505A0</td> <td>WALL PASSING WITH DIAPHRAGM</td> <td>3.000</td> <td>PC</td> </tr> <tr> <td>VM2055A0</td> <td>UPPER WALL PASSING ACCESSORY CABLES</td> <td>1.000</td> <td>PC</td> </tr> <tr> <td>VM2056A0</td> <td>LOWER WALL PASSING ACCESSORY CABLES</td> <td>1.000</td> <td>PC</td> </tr> </tbody> </table>	Code	Description	Qty	UOM	VI1220A1	4,2x12 TCB SELF-TAPPIN G SCREW	1.000	PC	VM1505A0	WALL PASSING WITH DIAPHRAGM	3.000	PC	VM2055A0	UPPER WALL PASSING ACCESSORY CABLES	1.000	PC	VM2056A0	LOWER WALL PASSING ACCESSORY CABLES	1.000	PC
Code	Description	Qty	UOM																						
VI1220A1	4,2x12 TCB SELF-TAPPIN G SCREW	1.000	PC																						
VM1505A0	WALL PASSING WITH DIAPHRAGM	3.000	PC																						
VM2055A0	UPPER WALL PASSING ACCESSORY CABLES	1.000	PC																						
VM2056A0	LOWER WALL PASSING ACCESSORY CABLES	1.000	PC																						



COMPONENT			SPARE PART		
<i>Code</i>	<i>Description</i>	<i>Image</i>	<i>Code</i>	<i>Description</i>	<i>Kit components</i>
VM2389A	MM H40 DECKTOP FOOT		VM2389A0	MM H40 DECKTOP FOOT	

ASM4039A/0.D02 - Door

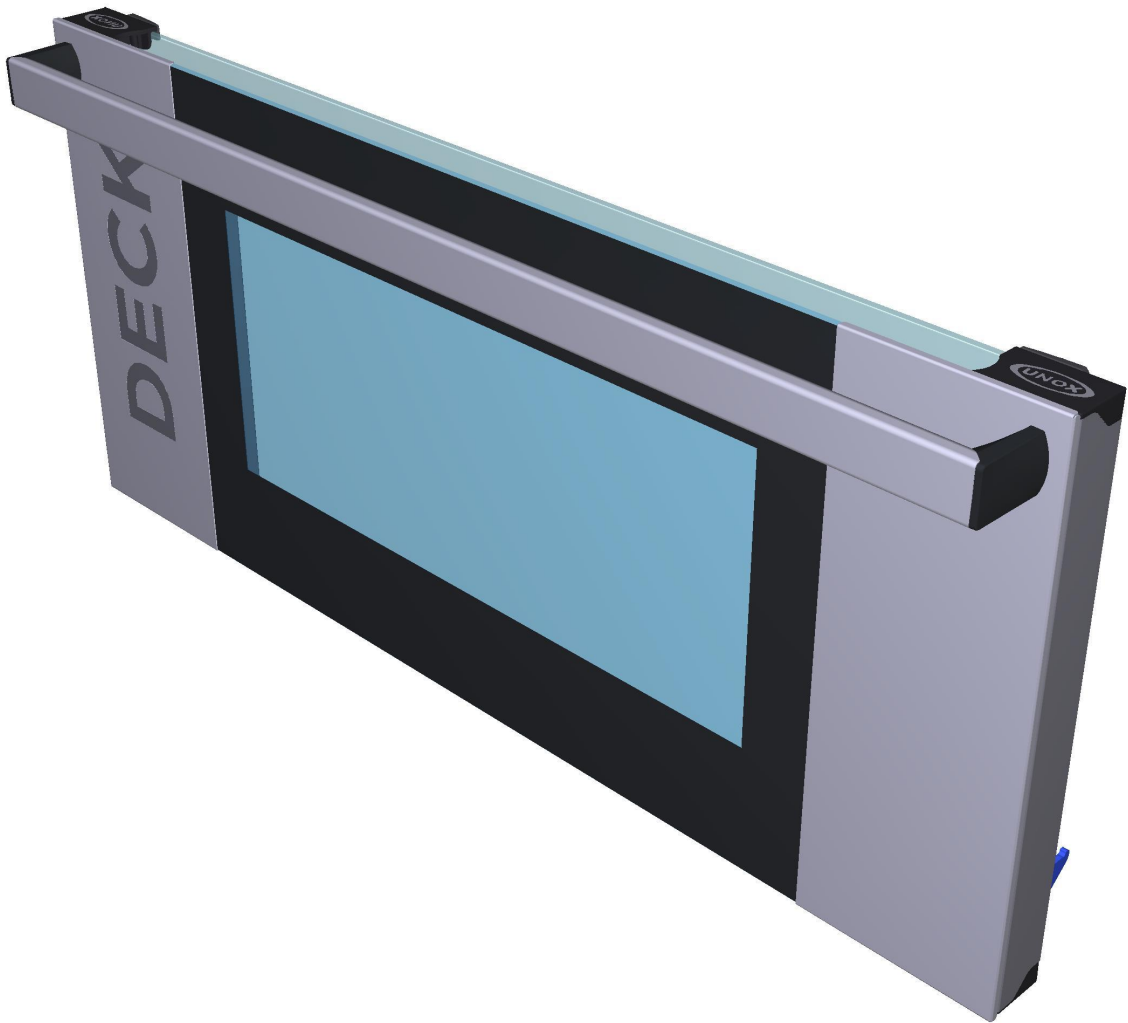

FRONT

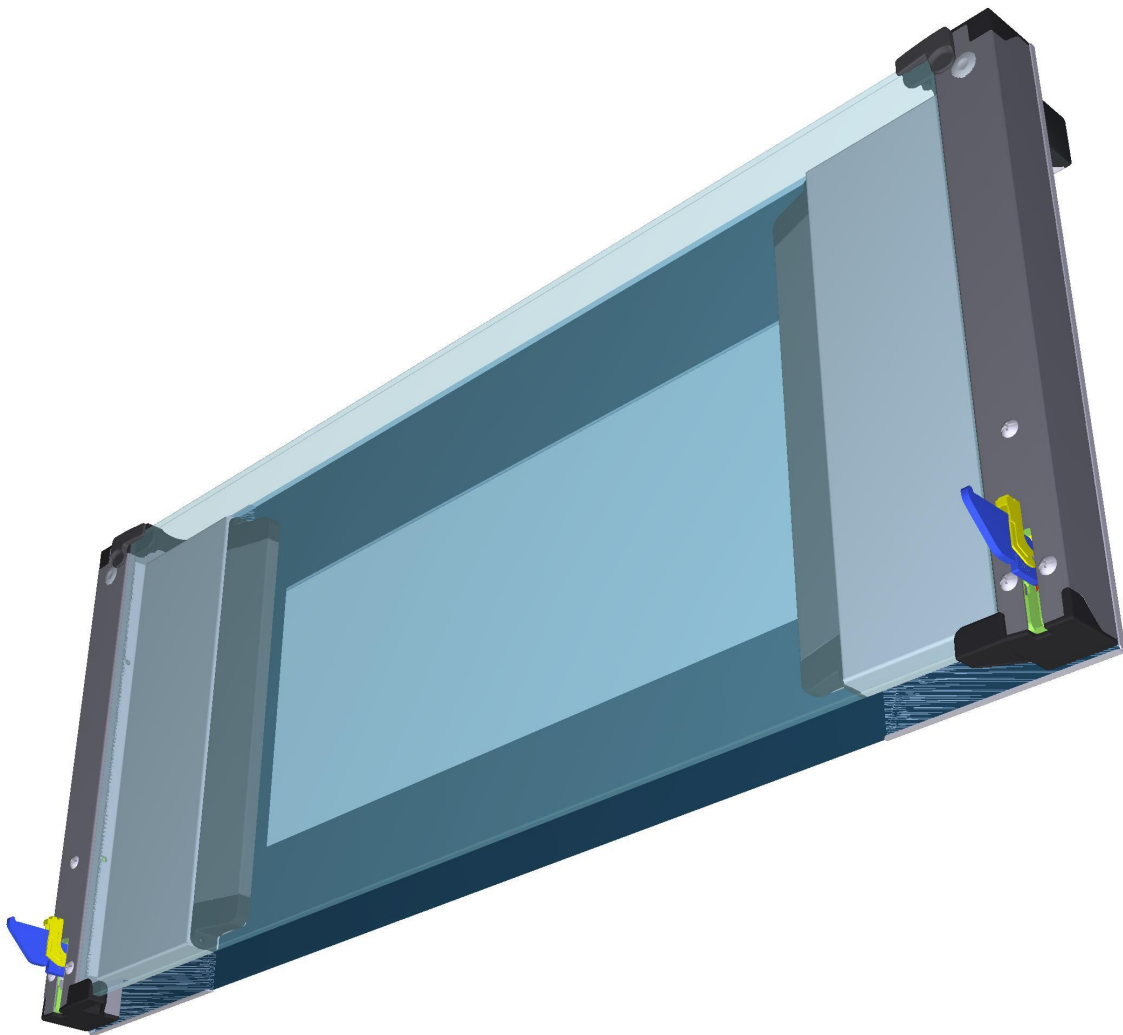

ASM4039A/0.D02 - Door

REAR



COMPONENT			SPARE PART																																																										
Code	Description	Image	Code	Description	Kit components																																																								
OB1001A	DECK OVEN DOOR LED FIXING PLATE		OB1001A2	DECK OVEN DOOR LED FIXING PLATE																																																									
CR1050A	XVC105/DECK/ROSELLA DOOR HINGE		KCR1050A	XVC105/DECK/ROSELLA HINGES KIT	<table border="1"> <thead> <tr> <th>Code</th> <th>Description</th> <th>Qty</th> <th>UOM</th> </tr> </thead> <tbody> <tr> <td>CR1050A1</td> <td>XVC105/DECK/ROSELLA DOOR HINGE</td> <td>2.000</td> <td>PC</td> </tr> <tr> <td>VI1280A3</td> <td>M5x10 TC1/2T SCREW</td> <td>6.000</td> <td>PC</td> </tr> </tbody> </table>	Code	Description	Qty	UOM	CR1050A1	XVC105/DECK/ROSELLA DOOR HINGE	2.000	PC	VI1280A3	M5x10 TC1/2T SCREW	6.000	PC																																												
Code	Description	Qty	UOM																																																										
CR1050A1	XVC105/DECK/ROSELLA DOOR HINGE	2.000	PC																																																										
VI1280A3	M5x10 TC1/2T SCREW	6.000	PC																																																										
VM1916A	RIGHT UPPER COLUMN CAP		KVT1253A	XF-XFT195-EG-VT1253A EXTERNAL GLASS KIT	<table border="1"> <thead> <tr> <th>Code</th> <th>Description</th> <th>Qty</th> <th>UOM</th> </tr> </thead> <tbody> <tr> <td>RC1200A0</td> <td>ED=4 WIRE D=0.5 H24 COMPRESSIO N SPRING</td> <td>2.000</td> <td>PC</td> </tr> <tr> <td>SL1050A1</td> <td>3M TRANSFER ADHESIVE TAPE</td> <td>0.820</td> <td>M</td> </tr> <tr> <td>TB2301A0</td> <td>RIGHT COLUMN XVC105E 40x40x1</td> <td>1.000</td> <td>PC</td> </tr> <tr> <td>TB3081A0</td> <td>LMISS ARIANNA/ROSELLA DOOR LEFT COLUMN</td> <td>1.000</td> <td>PC</td> </tr> <tr> <td>VM1025A0</td> <td>Ø16 GREY NYLON LID</td> <td>2.000</td> <td>PC</td> </tr> <tr> <td>VM1695A0</td> <td>HANDLE POSITION PIN</td> <td>2.000</td> <td>PC</td> </tr> <tr> <td>VM1916A0</td> <td>RIGHT UPPER COLUMN CAP</td> <td>1.000</td> <td>PC</td> </tr> <tr> <td>VM1917A0</td> <td>LEFT UPPER COLUMN CAP</td> <td>1.000</td> <td>PC</td> </tr> <tr> <td>VM1918A0</td> <td>RIGHT LOWER COLUMN CAP</td> <td>1.000</td> <td>PC</td> </tr> <tr> <td>VM1919A0</td> <td>LEFT LOWER COLUMN CAP</td> <td>1.000</td> <td>PC</td> </tr> <tr> <td>VM1920A0</td> <td>INTERNAL GLASS CLOSING RIGHT PLATE</td> <td>1.000</td> <td>PC</td> </tr> <tr> <td>VM1921A0</td> <td>INTERNAL GLASS CLOSING LEFT PLATE</td> <td>1.000</td> <td>PC</td> </tr> <tr> <td>VT1253A0</td> <td>XF-XFT195 DOOR EXT. BLACK GLASS-ENGELF OOD</td> <td>1.000</td> <td>PC</td> </tr> </tbody> </table>	Code	Description	Qty	UOM	RC1200A0	ED=4 WIRE D=0.5 H24 COMPRESSIO N SPRING	2.000	PC	SL1050A1	3M TRANSFER ADHESIVE TAPE	0.820	M	TB2301A0	RIGHT COLUMN XVC105E 40x40x1	1.000	PC	TB3081A0	LMISS ARIANNA/ROSELLA DOOR LEFT COLUMN	1.000	PC	VM1025A0	Ø16 GREY NYLON LID	2.000	PC	VM1695A0	HANDLE POSITION PIN	2.000	PC	VM1916A0	RIGHT UPPER COLUMN CAP	1.000	PC	VM1917A0	LEFT UPPER COLUMN CAP	1.000	PC	VM1918A0	RIGHT LOWER COLUMN CAP	1.000	PC	VM1919A0	LEFT LOWER COLUMN CAP	1.000	PC	VM1920A0	INTERNAL GLASS CLOSING RIGHT PLATE	1.000	PC	VM1921A0	INTERNAL GLASS CLOSING LEFT PLATE	1.000	PC	VT1253A0	XF-XFT195 DOOR EXT. BLACK GLASS-ENGELF OOD	1.000	PC
Code	Description	Qty	UOM																																																										
RC1200A0	ED=4 WIRE D=0.5 H24 COMPRESSIO N SPRING	2.000	PC																																																										
SL1050A1	3M TRANSFER ADHESIVE TAPE	0.820	M																																																										
TB2301A0	RIGHT COLUMN XVC105E 40x40x1	1.000	PC																																																										
TB3081A0	LMISS ARIANNA/ROSELLA DOOR LEFT COLUMN	1.000	PC																																																										
VM1025A0	Ø16 GREY NYLON LID	2.000	PC																																																										
VM1695A0	HANDLE POSITION PIN	2.000	PC																																																										
VM1916A0	RIGHT UPPER COLUMN CAP	1.000	PC																																																										
VM1917A0	LEFT UPPER COLUMN CAP	1.000	PC																																																										
VM1918A0	RIGHT LOWER COLUMN CAP	1.000	PC																																																										
VM1919A0	LEFT LOWER COLUMN CAP	1.000	PC																																																										
VM1920A0	INTERNAL GLASS CLOSING RIGHT PLATE	1.000	PC																																																										
VM1921A0	INTERNAL GLASS CLOSING LEFT PLATE	1.000	PC																																																										
VT1253A0	XF-XFT195 DOOR EXT. BLACK GLASS-ENGELF OOD	1.000	PC																																																										



COMPONENT			SPARE PART																																																																																	
Code	Description	Image	Code	Description	Kit components																																																																															
VM1916A	RIGHT UPPER COLUMN CAP		KVT1072A	L.M. ROSSELLA BLACK EXTERNAL GLASS KIT	<table border="1"> <thead> <tr> <th>Code</th> <th>Description</th> <th>Qty</th> <th>UOM</th> </tr> </thead> <tbody> <tr> <td>RC1200A0</td> <td>ED=4 WIRE D=0.5 H24 COMPRESSIO N SPRING</td> <td>2.000</td> <td>PC</td> </tr> <tr> <td>SL1050A1</td> <td>3M TRANSFER ADHESIVE TAPE</td> <td>0.820</td> <td>M</td> </tr> <tr> <td>TB2301A0</td> <td>RIGHT COLUMN XVC105E 40x40x1</td> <td>1.000</td> <td>PC</td> </tr> <tr> <td>TB3081A0</td> <td>LMISS ARIANNA/ROS SELLA DOOR LEFT COLUMN</td> <td>1.000</td> <td>PC</td> </tr> <tr> <td>VM1025A0</td> <td>Ø16 GREY NYLON LID</td> <td>2.000</td> <td>PC</td> </tr> <tr> <td>VM1695A0</td> <td>HANDLE POSITION PIN</td> <td>2.000</td> <td>PC</td> </tr> <tr> <td>VM1916A0</td> <td>RIGHT UPPER COLUMN CAP</td> <td>1.000</td> <td>PC</td> </tr> <tr> <td>VM1917A0</td> <td>LEFT UPPER COLUMN CAP</td> <td>1.000</td> <td>PC</td> </tr> <tr> <td>VM1918A0</td> <td>RIGHT LOWER COLUMN CAP</td> <td>1.000</td> <td>PC</td> </tr> <tr> <td>VM1919A0</td> <td>LEFT LOWER COLUMN CAP</td> <td>1.000</td> <td>PC</td> </tr> <tr> <td>VM1920A0</td> <td>INTERNAL GLASS CLOSING RIGHT PLATE</td> <td>1.000</td> <td>PC</td> </tr> <tr> <td>VM1921A0</td> <td>INTERNAL GLASS CLOSING LEFT PLATE</td> <td>1.000</td> <td>PC</td> </tr> <tr> <td>VT1072A0</td> <td>LineMiss ROSSELLA BLACK EXTERNAL GLASS</td> <td>1.000</td> <td>PC</td> </tr> </tbody> </table>	Code	Description	Qty	UOM	RC1200A0	ED=4 WIRE D=0.5 H24 COMPRESSIO N SPRING	2.000	PC	SL1050A1	3M TRANSFER ADHESIVE TAPE	0.820	M	TB2301A0	RIGHT COLUMN XVC105E 40x40x1	1.000	PC	TB3081A0	LMISS ARIANNA/ROS SELLA DOOR LEFT COLUMN	1.000	PC	VM1025A0	Ø16 GREY NYLON LID	2.000	PC	VM1695A0	HANDLE POSITION PIN	2.000	PC	VM1916A0	RIGHT UPPER COLUMN CAP	1.000	PC	VM1917A0	LEFT UPPER COLUMN CAP	1.000	PC	VM1918A0	RIGHT LOWER COLUMN CAP	1.000	PC	VM1919A0	LEFT LOWER COLUMN CAP	1.000	PC	VM1920A0	INTERNAL GLASS CLOSING RIGHT PLATE	1.000	PC	VM1921A0	INTERNAL GLASS CLOSING LEFT PLATE	1.000	PC	VT1072A0	LineMiss ROSSELLA BLACK EXTERNAL GLASS	1.000	PC	KVT1071A	L.M. ROSSELLA EXTERNAL GLASS KIT	<table border="1"> <thead> <tr> <th>Code</th> <th>Description</th> <th>Qty</th> <th>UOM</th> </tr> </thead> <tbody> <tr> <td>RC1200A0</td> <td>ED=4 WIRE D=0.5 H24 COMPRESSIO N SPRING</td> <td>2.000</td> <td>PC</td> </tr> <tr> <td>SL1050A1</td> <td>3M TRANSFER ADHESIVE TAPE</td> <td>0.820</td> <td>M</td> </tr> <tr> <td>TB2301A0</td> <td>RIGHT COLUMN XVC105E 40x40x1</td> <td>2.000</td> <td>PC</td> </tr> <tr> <td>VM1025A0</td> <td>Ø16 GREY NYLON LID</td> <td>2.000</td> <td>PC</td> </tr> </tbody> </table>	Code	Description	Qty	UOM	RC1200A0	ED=4 WIRE D=0.5 H24 COMPRESSIO N SPRING	2.000	PC	SL1050A1	3M TRANSFER ADHESIVE TAPE	0.820	M	TB2301A0	RIGHT COLUMN XVC105E 40x40x1	2.000	PC	VM1025A0	Ø16 GREY NYLON LID	2.000	PC
			Code	Description	Qty	UOM																																																																														
RC1200A0	ED=4 WIRE D=0.5 H24 COMPRESSIO N SPRING	2.000	PC																																																																																	
SL1050A1	3M TRANSFER ADHESIVE TAPE	0.820	M																																																																																	
TB2301A0	RIGHT COLUMN XVC105E 40x40x1	1.000	PC																																																																																	
TB3081A0	LMISS ARIANNA/ROS SELLA DOOR LEFT COLUMN	1.000	PC																																																																																	
VM1025A0	Ø16 GREY NYLON LID	2.000	PC																																																																																	
VM1695A0	HANDLE POSITION PIN	2.000	PC																																																																																	
VM1916A0	RIGHT UPPER COLUMN CAP	1.000	PC																																																																																	
VM1917A0	LEFT UPPER COLUMN CAP	1.000	PC																																																																																	
VM1918A0	RIGHT LOWER COLUMN CAP	1.000	PC																																																																																	
VM1919A0	LEFT LOWER COLUMN CAP	1.000	PC																																																																																	
VM1920A0	INTERNAL GLASS CLOSING RIGHT PLATE	1.000	PC																																																																																	
VM1921A0	INTERNAL GLASS CLOSING LEFT PLATE	1.000	PC																																																																																	
VT1072A0	LineMiss ROSSELLA BLACK EXTERNAL GLASS	1.000	PC																																																																																	
Code	Description	Qty	UOM																																																																																	
RC1200A0	ED=4 WIRE D=0.5 H24 COMPRESSIO N SPRING	2.000	PC																																																																																	
SL1050A1	3M TRANSFER ADHESIVE TAPE	0.820	M																																																																																	
TB2301A0	RIGHT COLUMN XVC105E 40x40x1	2.000	PC																																																																																	
VM1025A0	Ø16 GREY NYLON LID	2.000	PC																																																																																	



COMPONENT			SPARE PART																																															
Code	Description	Image	Code	Description	Kit components																																													
VM1916A	RIGHT UPPER COLUMN CAP		KVT1071A	L.M. ROSSELLA EXTERNAL GLASS KIT	<table border="1"> <thead> <tr> <th>Code</th> <th>Description</th> <th>Qty</th> <th>UOM</th> </tr> </thead> <tbody> <tr> <td>VM1695A0</td> <td>HANDLE POSITION PIN</td> <td>2.000</td> <td>PC</td> </tr> <tr> <td>VM1916A0</td> <td>RIGHT UPPER COLUMN CAP</td> <td>1.000</td> <td>PC</td> </tr> <tr> <td>VM1917A0</td> <td>LEFT UPPER COLUMN CAP</td> <td>1.000</td> <td>PC</td> </tr> <tr> <td>VM1918A0</td> <td>RIGHT LOWER COLUMN CAP</td> <td>1.000</td> <td>PC</td> </tr> <tr> <td>VM1919A0</td> <td>LEFT LOWER COLUMN CAP</td> <td>1.000</td> <td>PC</td> </tr> <tr> <td>VM1920A0</td> <td>INTERNAL GLASS CLOSING RIGHT PLATE</td> <td>1.000</td> <td>PC</td> </tr> <tr> <td>VM1921A0</td> <td>INTERNAL GLASS CLOSING LEFT PLATE</td> <td>1.000</td> <td>PC</td> </tr> <tr> <td>VT1071A2</td> <td>YELLOW SER GLASS 798X424X5</td> <td>1.000</td> <td>PC</td> </tr> </tbody> </table>	Code	Description	Qty	UOM	VM1695A0	HANDLE POSITION PIN	2.000	PC	VM1916A0	RIGHT UPPER COLUMN CAP	1.000	PC	VM1917A0	LEFT UPPER COLUMN CAP	1.000	PC	VM1918A0	RIGHT LOWER COLUMN CAP	1.000	PC	VM1919A0	LEFT LOWER COLUMN CAP	1.000	PC	VM1920A0	INTERNAL GLASS CLOSING RIGHT PLATE	1.000	PC	VM1921A0	INTERNAL GLASS CLOSING LEFT PLATE	1.000	PC	VT1071A2	YELLOW SER GLASS 798X424X5	1.000	PC									
			Code	Description	Qty	UOM																																												
VM1695A0	HANDLE POSITION PIN	2.000	PC																																															
VM1916A0	RIGHT UPPER COLUMN CAP	1.000	PC																																															
VM1917A0	LEFT UPPER COLUMN CAP	1.000	PC																																															
VM1918A0	RIGHT LOWER COLUMN CAP	1.000	PC																																															
VM1919A0	LEFT LOWER COLUMN CAP	1.000	PC																																															
VM1920A0	INTERNAL GLASS CLOSING RIGHT PLATE	1.000	PC																																															
VM1921A0	INTERNAL GLASS CLOSING LEFT PLATE	1.000	PC																																															
VT1071A2	YELLOW SER GLASS 798X424X5	1.000	PC																																															
KVT1067A	L.M. ELENA BLACK EXTERNAL GLASS KIT	<table border="1"> <thead> <tr> <th>Code</th> <th>Description</th> <th>Qty</th> <th>UOM</th> </tr> </thead> <tbody> <tr> <td>RC1200A0</td> <td>ED=4 WIRE D=0.5 H24 COMPRESSIO N SPRING</td> <td>2.000</td> <td>PC</td> </tr> <tr> <td>SL1050A1</td> <td>3M TRANSFER ADHESIVE TAPE</td> <td>0.660</td> <td>M</td> </tr> <tr> <td>TB2306A0</td> <td>L.Miss Stefania/Elena DOOR RIGHT COLUMN</td> <td>1.000</td> <td>PC</td> </tr> <tr> <td>TB3080A0</td> <td>LMISS STEFANIA/ELE NA DOOR LEFT COLUMN</td> <td>1.000</td> <td>PC</td> </tr> <tr> <td>VM1025A0</td> <td>Ø16 GREY NYLON LID</td> <td>2.000</td> <td>PC</td> </tr> <tr> <td>VM1695A0</td> <td>HANDLE POSITION PIN</td> <td>2.000</td> <td>PC</td> </tr> <tr> <td>VM1916A0</td> <td>RIGHT UPPER COLUMN CAP</td> <td>1.000</td> <td>PC</td> </tr> <tr> <td>VM1917A0</td> <td>LEFT UPPER COLUMN CAP</td> <td>1.000</td> <td>PC</td> </tr> <tr> <td>VM1918A0</td> <td>RIGHT LOWER COLUMN CAP</td> <td>1.000</td> <td>PC</td> </tr> <tr> <td>VM1919A0</td> <td>LEFT LOWER COLUMN CAP</td> <td>1.000</td> <td>PC</td> </tr> <tr> <td>VM1920A0</td> <td>INTERNAL GLASS CLOSING RIGHT PLATE</td> <td>1.000</td> <td>PC</td> </tr> </tbody> </table>	Code	Description	Qty	UOM	RC1200A0	ED=4 WIRE D=0.5 H24 COMPRESSIO N SPRING	2.000	PC	SL1050A1	3M TRANSFER ADHESIVE TAPE	0.660	M	TB2306A0	L.Miss Stefania/Elena DOOR RIGHT COLUMN	1.000	PC	TB3080A0	LMISS STEFANIA/ELE NA DOOR LEFT COLUMN	1.000	PC	VM1025A0	Ø16 GREY NYLON LID	2.000	PC	VM1695A0	HANDLE POSITION PIN	2.000	PC	VM1916A0	RIGHT UPPER COLUMN CAP	1.000	PC	VM1917A0	LEFT UPPER COLUMN CAP	1.000	PC	VM1918A0	RIGHT LOWER COLUMN CAP	1.000	PC	VM1919A0	LEFT LOWER COLUMN CAP	1.000	PC	VM1920A0	INTERNAL GLASS CLOSING RIGHT PLATE	1.000	PC
Code	Description	Qty	UOM																																															
RC1200A0	ED=4 WIRE D=0.5 H24 COMPRESSIO N SPRING	2.000	PC																																															
SL1050A1	3M TRANSFER ADHESIVE TAPE	0.660	M																																															
TB2306A0	L.Miss Stefania/Elena DOOR RIGHT COLUMN	1.000	PC																																															
TB3080A0	LMISS STEFANIA/ELE NA DOOR LEFT COLUMN	1.000	PC																																															
VM1025A0	Ø16 GREY NYLON LID	2.000	PC																																															
VM1695A0	HANDLE POSITION PIN	2.000	PC																																															
VM1916A0	RIGHT UPPER COLUMN CAP	1.000	PC																																															
VM1917A0	LEFT UPPER COLUMN CAP	1.000	PC																																															
VM1918A0	RIGHT LOWER COLUMN CAP	1.000	PC																																															
VM1919A0	LEFT LOWER COLUMN CAP	1.000	PC																																															
VM1920A0	INTERNAL GLASS CLOSING RIGHT PLATE	1.000	PC																																															



COMPONENT			SPARE PART																																																			
Code	Description	Image	Code	Description	Kit components																																																	
VM1916A	RIGHT UPPER COLUMN CAP		KVT1067A	L.M. ELENA BLACK EXTERNAL GLASS KIT	<table border="1"> <thead> <tr> <th>Code</th> <th>Description</th> <th>Qty</th> <th>UOM</th> </tr> </thead> <tbody> <tr> <td>VM1921A0</td> <td>INTERNAL GLASS CLOSING LEFT PLATE</td> <td>1.000</td> <td>PC</td> </tr> <tr> <td>VT1067A0</td> <td>LineMiss ELENA BLACK EXTERNAL DOOR GLASS</td> <td>1.000</td> <td>PC</td> </tr> </tbody> </table>	Code	Description	Qty	UOM	VM1921A0	INTERNAL GLASS CLOSING LEFT PLATE	1.000	PC	VT1067A0	LineMiss ELENA BLACK EXTERNAL DOOR GLASS	1.000	PC																																					
			Code	Description	Qty	UOM																																																
			VM1921A0	INTERNAL GLASS CLOSING LEFT PLATE	1.000	PC																																																
VT1067A0	LineMiss ELENA BLACK EXTERNAL DOOR GLASS	1.000	PC																																																			
KVT1066A	L.M. ELENA EXTERNAL GLASS KIT	<table border="1"> <thead> <tr> <th>Code</th> <th>Description</th> <th>Qty</th> <th>UOM</th> </tr> </thead> <tbody> <tr> <td>RC1200A0</td> <td>ED=4 WIRE D=0.5 H24 COMPRESSIO N SPRING</td> <td>2.000</td> <td>PC</td> </tr> <tr> <td>SL1050A1</td> <td>3M TRANSFER ADHESIVE TAPE</td> <td>0.660</td> <td>M</td> </tr> <tr> <td>TB2306A0</td> <td>LMiss Stefania/Elena DOOR RIGHT COLUMN</td> <td>2.000</td> <td>PC</td> </tr> <tr> <td>VM1025A0</td> <td>Ø16 GREY NYLON LID</td> <td>2.000</td> <td>PC</td> </tr> <tr> <td>VM1695A0</td> <td>HANDLE POSITION PIN</td> <td>2.000</td> <td>PC</td> </tr> <tr> <td>VM1916A0</td> <td>RIGHT UPPER COLUMN CAP</td> <td>1.000</td> <td>PC</td> </tr> <tr> <td>VM1917A0</td> <td>LEFT UPPER COLUMN CAP</td> <td>1.000</td> <td>PC</td> </tr> <tr> <td>VM1918A0</td> <td>RIGHT LOWER COLUMN CAP</td> <td>1.000</td> <td>PC</td> </tr> <tr> <td>VM1919A0</td> <td>LEFT LOWER COLUMN CAP</td> <td>1.000</td> <td>PC</td> </tr> <tr> <td>VM1920A0</td> <td>INTERNAL GLASS CLOSING RIGHT PLATE</td> <td>1.000</td> <td>PC</td> </tr> <tr> <td>VM1921A0</td> <td>INTERNAL GLASS CLOSING LEFT PLATE</td> <td>1.000</td> <td>PC</td> </tr> <tr> <td>VT1066A2</td> <td>YELLOW SER GLASS 798X344X5</td> <td>1.000</td> <td>PC</td> </tr> </tbody> </table>	Code	Description	Qty	UOM	RC1200A0	ED=4 WIRE D=0.5 H24 COMPRESSIO N SPRING	2.000	PC	SL1050A1	3M TRANSFER ADHESIVE TAPE	0.660	M	TB2306A0	LMiss Stefania/Elena DOOR RIGHT COLUMN	2.000	PC	VM1025A0	Ø16 GREY NYLON LID	2.000	PC	VM1695A0	HANDLE POSITION PIN	2.000	PC	VM1916A0	RIGHT UPPER COLUMN CAP	1.000	PC	VM1917A0	LEFT UPPER COLUMN CAP	1.000	PC	VM1918A0	RIGHT LOWER COLUMN CAP	1.000	PC	VM1919A0	LEFT LOWER COLUMN CAP	1.000	PC	VM1920A0	INTERNAL GLASS CLOSING RIGHT PLATE	1.000	PC	VM1921A0	INTERNAL GLASS CLOSING LEFT PLATE	1.000	PC	VT1066A2	YELLOW SER GLASS 798X344X5	1.000	PC
Code	Description	Qty	UOM																																																			
RC1200A0	ED=4 WIRE D=0.5 H24 COMPRESSIO N SPRING	2.000	PC																																																			
SL1050A1	3M TRANSFER ADHESIVE TAPE	0.660	M																																																			
TB2306A0	LMiss Stefania/Elena DOOR RIGHT COLUMN	2.000	PC																																																			
VM1025A0	Ø16 GREY NYLON LID	2.000	PC																																																			
VM1695A0	HANDLE POSITION PIN	2.000	PC																																																			
VM1916A0	RIGHT UPPER COLUMN CAP	1.000	PC																																																			
VM1917A0	LEFT UPPER COLUMN CAP	1.000	PC																																																			
VM1918A0	RIGHT LOWER COLUMN CAP	1.000	PC																																																			
VM1919A0	LEFT LOWER COLUMN CAP	1.000	PC																																																			
VM1920A0	INTERNAL GLASS CLOSING RIGHT PLATE	1.000	PC																																																			
VM1921A0	INTERNAL GLASS CLOSING LEFT PLATE	1.000	PC																																																			
VT1066A2	YELLOW SER GLASS 798X344X5	1.000	PC																																																			
KVM1916A	LMISS 60x40 RIGHT UPPER DOOR COLUMN CAP	<table border="1"> <thead> <tr> <th>Code</th> <th>Description</th> <th>Qty</th> <th>UOM</th> </tr> </thead> <tbody> <tr> <td>VM1916A0</td> <td>RIGHT UPPER COLUMN CAP</td> <td>1.000</td> <td>PC</td> </tr> </tbody> </table>	Code	Description	Qty	UOM	VM1916A0	RIGHT UPPER COLUMN CAP	1.000	PC																																												
Code	Description	Qty	UOM																																																			
VM1916A0	RIGHT UPPER COLUMN CAP	1.000	PC																																																			







COMPONENT			SPARE PART																						
Code	Description	Image	Code	Description	Kit components																				
VM1920A	INTERNAL GLASS CLOSING RIGHT PLATE		KVM1920A	LM INNER GLASS STOPPER 2PCS KIT	<table border="1"> <thead> <tr> <th>Code</th> <th>Description</th> <th>Qty</th> <th>UOM</th> </tr> </thead> <tbody> <tr> <td>RC1200A0</td> <td>ED=4 WIRE D=0.5 H24 COMPRESSIO N SPRING</td> <td>2.000</td> <td>PC</td> </tr> <tr> <td>VM1695A0</td> <td>HANDLE POSITION PIN</td> <td>2.000</td> <td>PC</td> </tr> <tr> <td>VM1920A0</td> <td>INTERNAL GLASS CLOSING RIGHT PLATE</td> <td>1.000</td> <td>PC</td> </tr> <tr> <td>VM1921A0</td> <td>INTERNAL GLASS CLOSING LEFT PLATE</td> <td>1.000</td> <td>PC</td> </tr> </tbody> </table>	Code	Description	Qty	UOM	RC1200A0	ED=4 WIRE D=0.5 H24 COMPRESSIO N SPRING	2.000	PC	VM1695A0	HANDLE POSITION PIN	2.000	PC	VM1920A0	INTERNAL GLASS CLOSING RIGHT PLATE	1.000	PC	VM1921A0	INTERNAL GLASS CLOSING LEFT PLATE	1.000	PC
					Code	Description	Qty	UOM																	
					RC1200A0	ED=4 WIRE D=0.5 H24 COMPRESSIO N SPRING	2.000	PC																	
					VM1695A0	HANDLE POSITION PIN	2.000	PC																	
VM1920A0	INTERNAL GLASS CLOSING RIGHT PLATE	1.000	PC																						
VM1921A0	INTERNAL GLASS CLOSING LEFT PLATE	1.000	PC																						
<table border="1"> <thead> <tr> <th>Code</th> <th>Description</th> <th>Qty</th> <th>UOM</th> </tr> </thead> <tbody> <tr> <td>VM1917A0</td> <td>LEFT UPPER COLUMN CAP</td> <td>1.000</td> <td>PC</td> </tr> </tbody> </table>	Code	Description	Qty	UOM	VM1917A0	LEFT UPPER COLUMN CAP	1.000	PC																	
Code	Description	Qty	UOM																						
VM1917A0	LEFT UPPER COLUMN CAP	1.000	PC																						
<table border="1"> <thead> <tr> <th>Code</th> <th>Description</th> <th>Qty</th> <th>UOM</th> </tr> </thead> <tbody> <tr> <td>LP1054A0</td> <td>DECK LED BA</td> <td>1.000</td> <td>PC</td> </tr> <tr> <td>VI1220A1</td> <td>4,2x12 TCB SELF-TAPPIN G SCREW</td> <td>2.000</td> <td>PC</td> </tr> </tbody> </table>	Code	Description	Qty	UOM	LP1054A0	DECK LED BA	1.000	PC	VI1220A1	4,2x12 TCB SELF-TAPPIN G SCREW	2.000	PC													
Code	Description	Qty	UOM																						
LP1054A0	DECK LED BA	1.000	PC																						
VI1220A1	4,2x12 TCB SELF-TAPPIN G SCREW	2.000	PC																						
VM1917A	LEFT UPPER COLUMN CAP		KVM1917A	LMISS 60x40 LEFT UPPER DOOR COLUMN CAP	<table border="1"> <thead> <tr> <th>Code</th> <th>Description</th> <th>Qty</th> <th>UOM</th> </tr> </thead> <tbody> <tr> <td>VM1917A0</td> <td>LEFT UPPER COLUMN CAP</td> <td>1.000</td> <td>PC</td> </tr> </tbody> </table>	Code	Description	Qty	UOM	VM1917A0	LEFT UPPER COLUMN CAP	1.000	PC												
Code	Description	Qty	UOM																						
VM1917A0	LEFT UPPER COLUMN CAP	1.000	PC																						
LP1054A	DECK LED BAR		KLP1054A	DECK LED BAR KIT	<table border="1"> <thead> <tr> <th>Code</th> <th>Description</th> <th>Qty</th> <th>UOM</th> </tr> </thead> <tbody> <tr> <td>LP1054A0</td> <td>DECK LED BA</td> <td>1.000</td> <td>PC</td> </tr> <tr> <td>VI1220A1</td> <td>4,2x12 TCB SELF-TAPPIN G SCREW</td> <td>2.000</td> <td>PC</td> </tr> </tbody> </table>	Code	Description	Qty	UOM	LP1054A0	DECK LED BA	1.000	PC	VI1220A1	4,2x12 TCB SELF-TAPPIN G SCREW	2.000	PC								
Code	Description	Qty	UOM																						
LP1054A0	DECK LED BA	1.000	PC																						
VI1220A1	4,2x12 TCB SELF-TAPPIN G SCREW	2.000	PC																						
TB2183B	AUTONOMOUS DECK OVEN LEFT COLUMN		TB2183B1	AUTONOMOUS DECK OVEN LEFT COLUMN																					



COMPONENT			SPARE PART																		
Code	Description	Image	Code	Description	Kit components																
TB2184B	AUTONOMOUS DECK OVEN RIGHT COLUMN		TB2184B1	AUTONOMOUS DECK OVEN RIGHT COLUMN																	
TB3347A	TB3347A0		KTB3347A	DECKOVEN HANDLE TUBE KIT	<table border="1"> <thead> <tr> <th>Code</th> <th>Description</th> <th>Qty</th> <th>UOM</th> </tr> </thead> <tbody> <tr> <td>TB3347A0</td> <td>TB3347A0</td> <td>1.000</td> <td>PC</td> </tr> <tr> <td>VI1855A0</td> <td>5X25 SELF-TAPPING G SCREW</td> <td>2.000</td> <td>PC</td> </tr> <tr> <td>VM2516A0</td> <td>BL SP PROVER HANDLE END</td> <td>2.000</td> <td>PC</td> </tr> </tbody> </table>	Code	Description	Qty	UOM	TB3347A0	TB3347A0	1.000	PC	VI1855A0	5X25 SELF-TAPPING G SCREW	2.000	PC	VM2516A0	BL SP PROVER HANDLE END	2.000	PC
Code	Description	Qty	UOM																		
TB3347A0	TB3347A0	1.000	PC																		
VI1855A0	5X25 SELF-TAPPING G SCREW	2.000	PC																		
VM2516A0	BL SP PROVER HANDLE END	2.000	PC																		
VI1855A	5X25 SELF-TAPPING SCREW		KVI1855A	5x25 SELF-TAPPING SCREW 20 PCS.	<table border="1"> <thead> <tr> <th>Code</th> <th>Description</th> <th>Qty</th> <th>UOM</th> </tr> </thead> <tbody> <tr> <td>VI1855A0</td> <td>5X25 SELF-TAPPING G SCREW</td> <td>20.000</td> <td>PC</td> </tr> </tbody> </table>	Code	Description	Qty	UOM	VI1855A0	5X25 SELF-TAPPING G SCREW	20.000	PC								
Code	Description	Qty	UOM																		
VI1855A0	5X25 SELF-TAPPING G SCREW	20.000	PC																		
VM1025A	Ø16 GREY NYLON LI		KVM1025A	GREY NYLON CAPS 20 PCS KIT	<table border="1"> <thead> <tr> <th>Code</th> <th>Description</th> <th>Qty</th> <th>UOM</th> </tr> </thead> <tbody> <tr> <td>VM1025A0</td> <td>Ø16 GREY NYLON LID</td> <td>20.000</td> <td>PC</td> </tr> </tbody> </table>	Code	Description	Qty	UOM	VM1025A0	Ø16 GREY NYLON LID	20.000	PC								
Code	Description	Qty	UOM																		
VM1025A0	Ø16 GREY NYLON LID	20.000	PC																		
VM1918A	RIGHT LOWER COLUMN CAP		KVM1918A	LMISS 60x40 RIGHT LOWER DOOR COLUMN CAP	<table border="1"> <thead> <tr> <th>Code</th> <th>Description</th> <th>Qty</th> <th>UOM</th> </tr> </thead> <tbody> <tr> <td>VM1918A0</td> <td>RIGHT LOWER COLUMN CAP</td> <td>1.000</td> <td>PC</td> </tr> </tbody> </table>	Code	Description	Qty	UOM	VM1918A0	RIGHT LOWER COLUMN CAP	1.000	PC								
Code	Description	Qty	UOM																		
VM1918A0	RIGHT LOWER COLUMN CAP	1.000	PC																		

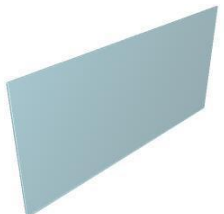

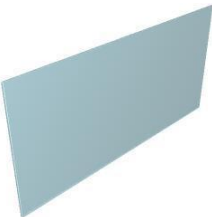
COMPONENT			SPARE PART																																																						
Code	Description	Image	Code	Description	Kit components																																																				
VM1919A	LEFT LOWER COLUMN CAP		KVM1919A	LMISS 60x40 LEFT LOWER DOOR COLUMN CAP	<table border="1"> <thead> <tr> <th>Code</th> <th>Description</th> <th>Qty</th> <th>UOM</th> </tr> </thead> <tbody> <tr> <td>VM1919A0</td> <td>LEFT LOWER COLUMN CAP</td> <td>1.000</td> <td>PC</td> </tr> </tbody> </table>	Code	Description	Qty	UOM	VM1919A0	LEFT LOWER COLUMN CAP	1.000	PC																																												
Code	Description	Qty	UOM																																																						
VM1919A0	LEFT LOWER COLUMN CAP	1.000	PC																																																						
VM2516A	BL SP PROVER HANDLE END		KVM2516A	BL SP PROVER 2 PCS HANDLE END KI	<table border="1"> <thead> <tr> <th>Code</th> <th>Description</th> <th>Qty</th> <th>UOM</th> </tr> </thead> <tbody> <tr> <td>V11147A0</td> <td>5X25 STAINLESS STEEL SCREW</td> <td>2.000</td> <td>PC</td> </tr> <tr> <td>VM2516A0</td> <td>BL SP PROVER HANDLE END</td> <td>2.000</td> <td>PC</td> </tr> </tbody> </table>	Code	Description	Qty	UOM	V11147A0	5X25 STAINLESS STEEL SCREW	2.000	PC	VM2516A0	BL SP PROVER HANDLE END	2.000	PC																																								
Code	Description	Qty	UOM																																																						
V11147A0	5X25 STAINLESS STEEL SCREW	2.000	PC																																																						
VM2516A0	BL SP PROVER HANDLE END	2.000	PC																																																						
VT1246A	DECK OVEN INTERNAL GLASS		KVT1246A KDR1077A	DECK OVEN INTERNAL GLASS KI XEBDC-0xEU-D COMPLETE DOOR	<table border="1"> <thead> <tr> <th>Code</th> <th>Description</th> <th>Qty</th> <th>UOM</th> </tr> </thead> <tbody> <tr> <td>VT1246A0</td> <td>DECK OVEN INTERNAL GLASS</td> <td>1.000</td> <td>PC</td> </tr> <tr> <td>0B1001A2</td> <td>DECK OVEN DOOR LED FIXING PLATE</td> <td>2.000</td> <td>PC</td> </tr> <tr> <td>0H7469A0</td> <td>DECKOVEN DOOR RIGHT PLATE</td> <td>1.000</td> <td>PC</td> </tr> <tr> <td>0H7470A0</td> <td>DECKOVEN DOOR LEFT PLATE</td> <td>1.000</td> <td>PC</td> </tr> <tr> <td>CR1050A1</td> <td>XVC105/DECK/ ROSSELLA DOOR HINGE</td> <td>2.000</td> <td>PC</td> </tr> <tr> <td>GN1665A0</td> <td>GN1665A0</td> <td>4.000</td> <td>PC</td> </tr> <tr> <td>LP1054A0</td> <td>DECK LED BA</td> <td>2.000</td> <td>PC</td> </tr> <tr> <td>RC1200A0</td> <td>ED=4 WIRE D=0.5 H24 COMPRESSIO N SPRING</td> <td>3.000</td> <td>PC</td> </tr> <tr> <td>SL1050A1</td> <td>3M TRANSFER ADHESIVE TAPE</td> <td>0.660</td> <td>M</td> </tr> <tr> <td>SL1155A1</td> <td>LOCTITE BICOMPONENT SILICON</td> <td>32.000</td> <td>ML</td> </tr> <tr> <td>TB2183B1</td> <td>AUTONOMOUS DECK OVEN LEFT COLUMN</td> <td>1.000</td> <td>PC</td> </tr> <tr> <td>TB2184B1</td> <td>AUTONOMOUS DECK OVEN RIGHT COLUMN</td> <td>1.000</td> <td>PC</td> </tr> </tbody> </table>	Code	Description	Qty	UOM	VT1246A0	DECK OVEN INTERNAL GLASS	1.000	PC	0B1001A2	DECK OVEN DOOR LED FIXING PLATE	2.000	PC	0H7469A0	DECKOVEN DOOR RIGHT PLATE	1.000	PC	0H7470A0	DECKOVEN DOOR LEFT PLATE	1.000	PC	CR1050A1	XVC105/DECK/ ROSSELLA DOOR HINGE	2.000	PC	GN1665A0	GN1665A0	4.000	PC	LP1054A0	DECK LED BA	2.000	PC	RC1200A0	ED=4 WIRE D=0.5 H24 COMPRESSIO N SPRING	3.000	PC	SL1050A1	3M TRANSFER ADHESIVE TAPE	0.660	M	SL1155A1	LOCTITE BICOMPONENT SILICON	32.000	ML	TB2183B1	AUTONOMOUS DECK OVEN LEFT COLUMN	1.000	PC	TB2184B1	AUTONOMOUS DECK OVEN RIGHT COLUMN	1.000	PC
Code	Description	Qty	UOM																																																						
VT1246A0	DECK OVEN INTERNAL GLASS	1.000	PC																																																						
0B1001A2	DECK OVEN DOOR LED FIXING PLATE	2.000	PC																																																						
0H7469A0	DECKOVEN DOOR RIGHT PLATE	1.000	PC																																																						
0H7470A0	DECKOVEN DOOR LEFT PLATE	1.000	PC																																																						
CR1050A1	XVC105/DECK/ ROSSELLA DOOR HINGE	2.000	PC																																																						
GN1665A0	GN1665A0	4.000	PC																																																						
LP1054A0	DECK LED BA	2.000	PC																																																						
RC1200A0	ED=4 WIRE D=0.5 H24 COMPRESSIO N SPRING	3.000	PC																																																						
SL1050A1	3M TRANSFER ADHESIVE TAPE	0.660	M																																																						
SL1155A1	LOCTITE BICOMPONENT SILICON	32.000	ML																																																						
TB2183B1	AUTONOMOUS DECK OVEN LEFT COLUMN	1.000	PC																																																						
TB2184B1	AUTONOMOUS DECK OVEN RIGHT COLUMN	1.000	PC																																																						

COMPONENT			SPARE PART																																																																						
Code	Description	Image	Code	Description	Kit components																																																																				
VT1246A	DECK OVEN INTERNAL GLASS		KDR1077A	XEBDC-0xEU-D COMPLETE DOOR	<table border="1"> <thead> <tr> <th>Code</th> <th>Description</th> <th>Qty</th> <th>UOM</th> </tr> </thead> <tbody> <tr> <td>TB3347A0</td> <td>TB3347A0</td> <td>1.000</td> <td>PC</td> </tr> <tr> <td>V11220A1</td> <td>4.2x12 TCB SELF-TAPPIN G SCREW</td> <td>8.000</td> <td>PC</td> </tr> <tr> <td>V11280A3</td> <td>M5x10 TC1/2T SCREW</td> <td>6.000</td> <td>PC</td> </tr> <tr> <td>V11855A0</td> <td>5X25 SELF-TAPPIN G SCREW</td> <td>2.000</td> <td>PC</td> </tr> <tr> <td>V11895A0</td> <td>BLIND NUT M4 STAINLESS STEEL DIN 917</td> <td>6.000</td> <td>PC</td> </tr> <tr> <td>VM1025A0</td> <td>Ø16 GREY NYLON LID</td> <td>2.000</td> <td>PC</td> </tr> <tr> <td>VM1145A1</td> <td>C.T. BOARD FRAME</td> <td>1.000</td> <td>PC</td> </tr> <tr> <td>VM1695A0</td> <td>HANDLE POSITION PIN</td> <td>2.000</td> <td>PC</td> </tr> <tr> <td>VM1916A0</td> <td>RIGHT UPPER COLUMN CAP</td> <td>1.000</td> <td>PC</td> </tr> <tr> <td>VM1917A0</td> <td>LEFT UPPER COLUMN CAP</td> <td>1.000</td> <td>PC</td> </tr> <tr> <td>VM1918A0</td> <td>RIGHT LOWER COLUMN CAP</td> <td>1.000</td> <td>PC</td> </tr> <tr> <td>VM1919A0</td> <td>LEFT LOWER COLUMN CAP</td> <td>1.000</td> <td>PC</td> </tr> <tr> <td>VM1920A0</td> <td>INTERNAL GLASS CLOSING RIGHT PLATE</td> <td>1.000</td> <td>PC</td> </tr> <tr> <td>VM1921A0</td> <td>INTERNAL GLASS CLOSING LEFT PLATE</td> <td>1.000</td> <td>PC</td> </tr> <tr> <td>VM2516A0</td> <td>BL SP PROVER HANDLE END</td> <td>2.000</td> <td>PC</td> </tr> <tr> <td>VT1310A0</td> <td>INDEPENDENT DECKOVEN EXT GLASS 856x383</td> <td>1.000</td> <td>PC</td> </tr> </tbody> </table>	Code	Description	Qty	UOM	TB3347A0	TB3347A0	1.000	PC	V11220A1	4.2x12 TCB SELF-TAPPIN G SCREW	8.000	PC	V11280A3	M5x10 TC1/2T SCREW	6.000	PC	V11855A0	5X25 SELF-TAPPIN G SCREW	2.000	PC	V11895A0	BLIND NUT M4 STAINLESS STEEL DIN 917	6.000	PC	VM1025A0	Ø16 GREY NYLON LID	2.000	PC	VM1145A1	C.T. BOARD FRAME	1.000	PC	VM1695A0	HANDLE POSITION PIN	2.000	PC	VM1916A0	RIGHT UPPER COLUMN CAP	1.000	PC	VM1917A0	LEFT UPPER COLUMN CAP	1.000	PC	VM1918A0	RIGHT LOWER COLUMN CAP	1.000	PC	VM1919A0	LEFT LOWER COLUMN CAP	1.000	PC	VM1920A0	INTERNAL GLASS CLOSING RIGHT PLATE	1.000	PC	VM1921A0	INTERNAL GLASS CLOSING LEFT PLATE	1.000	PC	VM2516A0	BL SP PROVER HANDLE END	2.000	PC	VT1310A0	INDEPENDENT DECKOVEN EXT GLASS 856x383	1.000	PC
					Code	Description	Qty	UOM																																																																	
TB3347A0	TB3347A0	1.000	PC																																																																						
V11220A1	4.2x12 TCB SELF-TAPPIN G SCREW	8.000	PC																																																																						
V11280A3	M5x10 TC1/2T SCREW	6.000	PC																																																																						
V11855A0	5X25 SELF-TAPPIN G SCREW	2.000	PC																																																																						
V11895A0	BLIND NUT M4 STAINLESS STEEL DIN 917	6.000	PC																																																																						
VM1025A0	Ø16 GREY NYLON LID	2.000	PC																																																																						
VM1145A1	C.T. BOARD FRAME	1.000	PC																																																																						
VM1695A0	HANDLE POSITION PIN	2.000	PC																																																																						
VM1916A0	RIGHT UPPER COLUMN CAP	1.000	PC																																																																						
VM1917A0	LEFT UPPER COLUMN CAP	1.000	PC																																																																						
VM1918A0	RIGHT LOWER COLUMN CAP	1.000	PC																																																																						
VM1919A0	LEFT LOWER COLUMN CAP	1.000	PC																																																																						
VM1920A0	INTERNAL GLASS CLOSING RIGHT PLATE	1.000	PC																																																																						
VM1921A0	INTERNAL GLASS CLOSING LEFT PLATE	1.000	PC																																																																						
VM2516A0	BL SP PROVER HANDLE END	2.000	PC																																																																						
VT1310A0	INDEPENDENT DECKOVEN EXT GLASS 856x383	1.000	PC																																																																						
VT1311A	CONTROLLED DECKOVEN EXT GLASS 856x383		KVT1311A	MM CONTROLLED DECKOVEN EXT GLASS	<table border="1"> <thead> <tr> <th>Code</th> <th>Description</th> <th>Qty</th> <th>UOM</th> </tr> </thead> <tbody> <tr> <td>0H7469A0</td> <td>DECKOVEN DOOR RIGHT PLATE</td> <td>1.000</td> <td>PC</td> </tr> <tr> <td>0H7470A0</td> <td>DECKOVEN DOOR LEFT PLATE</td> <td>1.000</td> <td>PC</td> </tr> <tr> <td>RC1200A0</td> <td>ED=4 WIRE D=0.5 H24 COMPRESSIO N SPRING</td> <td>2.000</td> <td>PC</td> </tr> </tbody> </table>	Code	Description	Qty	UOM	0H7469A0	DECKOVEN DOOR RIGHT PLATE	1.000	PC	0H7470A0	DECKOVEN DOOR LEFT PLATE	1.000	PC	RC1200A0	ED=4 WIRE D=0.5 H24 COMPRESSIO N SPRING	2.000	PC																																																				
Code	Description	Qty	UOM																																																																						
0H7469A0	DECKOVEN DOOR RIGHT PLATE	1.000	PC																																																																						
0H7470A0	DECKOVEN DOOR LEFT PLATE	1.000	PC																																																																						
RC1200A0	ED=4 WIRE D=0.5 H24 COMPRESSIO N SPRING	2.000	PC																																																																						



COMPONENT			SPARE PART																																																																													
Code	Description	Image	Code	Description	Kit components																																																																											
VT1311A	CONTROLLED DECKOVEN EXT GLASS 856x383		KVT1311A	MM CONTROLLED DECKOVEN EXT GLASS	<table border="1"> <thead> <tr> <th>Code</th> <th>Description</th> <th>Qty</th> <th>UOM</th> </tr> </thead> <tbody> <tr> <td>SL1050A1</td> <td>3M TRANSFER ADHESIVE TAPE</td> <td>0.660</td> <td>M</td> </tr> <tr> <td>SL1155A1</td> <td>LOCTITE BICOMPONEN T SILICON</td> <td>32.000</td> <td>ML</td> </tr> <tr> <td>SL1170A1</td> <td>S57 BLACK SILICON - 310ml CARTRIDGE</td> <td>1.000</td> <td>ML</td> </tr> <tr> <td>TB2183B1</td> <td>AUTONOMOU S DECK OVEN LEFT COLUMN</td> <td>1.000</td> <td>PC</td> </tr> <tr> <td>TB2184B1</td> <td>AUTONOMOU S DECK OVEN RIGHT COLUM</td> <td>1.000</td> <td>PC</td> </tr> <tr> <td>TB3347A0</td> <td>TB3347A0</td> <td>1.000</td> <td>PC</td> </tr> <tr> <td>VI1855A0</td> <td>5X25 SELF-TAPPIN G SCREW</td> <td>2.000</td> <td>PC</td> </tr> <tr> <td>VI1895A0</td> <td>BLIND NUT M4 STAINLESS STEEL DIN 917</td> <td>6.000</td> <td>PC</td> </tr> <tr> <td>VM1025A0</td> <td>Ø16 GREY NYLON LID</td> <td>2.000</td> <td>PC</td> </tr> <tr> <td>VM1145A1</td> <td>C.T. BOARD FRAME</td> <td>1.000</td> <td>PC</td> </tr> <tr> <td>VM1695A0</td> <td>HANDLE POSITION PIN</td> <td>2.000</td> <td>PC</td> </tr> <tr> <td>VM1916A0</td> <td>RIGHT UPPER COLUMN CAP</td> <td>1.000</td> <td>PC</td> </tr> <tr> <td>VM1917A0</td> <td>LEFT UPPER COLUMN CAP</td> <td>1.000</td> <td>PC</td> </tr> <tr> <td>VM1920A0</td> <td>INTERNAL GLASS CLOSING RIGHT PLATE</td> <td>1.000</td> <td>PC</td> </tr> <tr> <td>VM1921A0</td> <td>INTERNAL GLASS CLOSING LEFT PLATE</td> <td>1.000</td> <td>PC</td> </tr> <tr> <td>VM2516A0</td> <td>BL SP PROVER HANDLE END</td> <td>2.000</td> <td>PC</td> </tr> <tr> <td>VT1311A0</td> <td>CONTROLLED DECKOVEN EXT GLASS 856x383</td> <td>1.000</td> <td>PC</td> <td></td> <td></td> </tr> </tbody> </table>		Code	Description	Qty	UOM	SL1050A1	3M TRANSFER ADHESIVE TAPE	0.660	M	SL1155A1	LOCTITE BICOMPONEN T SILICON	32.000	ML	SL1170A1	S57 BLACK SILICON - 310ml CARTRIDGE	1.000	ML	TB2183B1	AUTONOMOU S DECK OVEN LEFT COLUMN	1.000	PC	TB2184B1	AUTONOMOU S DECK OVEN RIGHT COLUM	1.000	PC	TB3347A0	TB3347A0	1.000	PC	VI1855A0	5X25 SELF-TAPPIN G SCREW	2.000	PC	VI1895A0	BLIND NUT M4 STAINLESS STEEL DIN 917	6.000	PC	VM1025A0	Ø16 GREY NYLON LID	2.000	PC	VM1145A1	C.T. BOARD FRAME	1.000	PC	VM1695A0	HANDLE POSITION PIN	2.000	PC	VM1916A0	RIGHT UPPER COLUMN CAP	1.000	PC	VM1917A0	LEFT UPPER COLUMN CAP	1.000	PC	VM1920A0	INTERNAL GLASS CLOSING RIGHT PLATE	1.000	PC	VM1921A0	INTERNAL GLASS CLOSING LEFT PLATE	1.000	PC	VM2516A0	BL SP PROVER HANDLE END	2.000	PC	VT1311A0	CONTROLLED DECKOVEN EXT GLASS 856x383	1.000	PC		
Code	Description	Qty	UOM																																																																													
SL1050A1	3M TRANSFER ADHESIVE TAPE	0.660	M																																																																													
SL1155A1	LOCTITE BICOMPONEN T SILICON	32.000	ML																																																																													
SL1170A1	S57 BLACK SILICON - 310ml CARTRIDGE	1.000	ML																																																																													
TB2183B1	AUTONOMOU S DECK OVEN LEFT COLUMN	1.000	PC																																																																													
TB2184B1	AUTONOMOU S DECK OVEN RIGHT COLUM	1.000	PC																																																																													
TB3347A0	TB3347A0	1.000	PC																																																																													
VI1855A0	5X25 SELF-TAPPIN G SCREW	2.000	PC																																																																													
VI1895A0	BLIND NUT M4 STAINLESS STEEL DIN 917	6.000	PC																																																																													
VM1025A0	Ø16 GREY NYLON LID	2.000	PC																																																																													
VM1145A1	C.T. BOARD FRAME	1.000	PC																																																																													
VM1695A0	HANDLE POSITION PIN	2.000	PC																																																																													
VM1916A0	RIGHT UPPER COLUMN CAP	1.000	PC																																																																													
VM1917A0	LEFT UPPER COLUMN CAP	1.000	PC																																																																													
VM1920A0	INTERNAL GLASS CLOSING RIGHT PLATE	1.000	PC																																																																													
VM1921A0	INTERNAL GLASS CLOSING LEFT PLATE	1.000	PC																																																																													
VM2516A0	BL SP PROVER HANDLE END	2.000	PC																																																																													
VT1311A0	CONTROLLED DECKOVEN EXT GLASS 856x383	1.000	PC																																																																													



ASM4070A/0.D01 - General overview

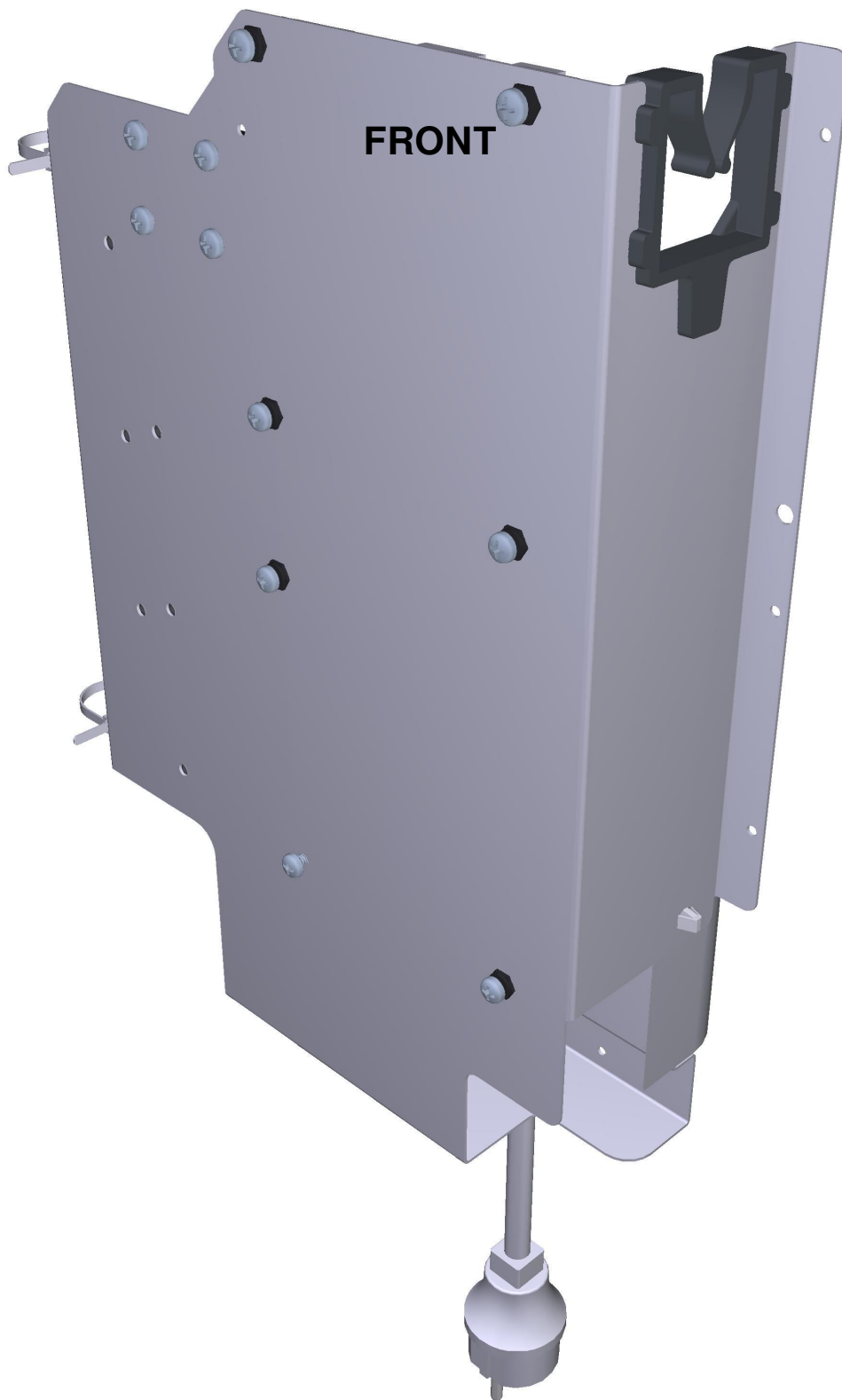





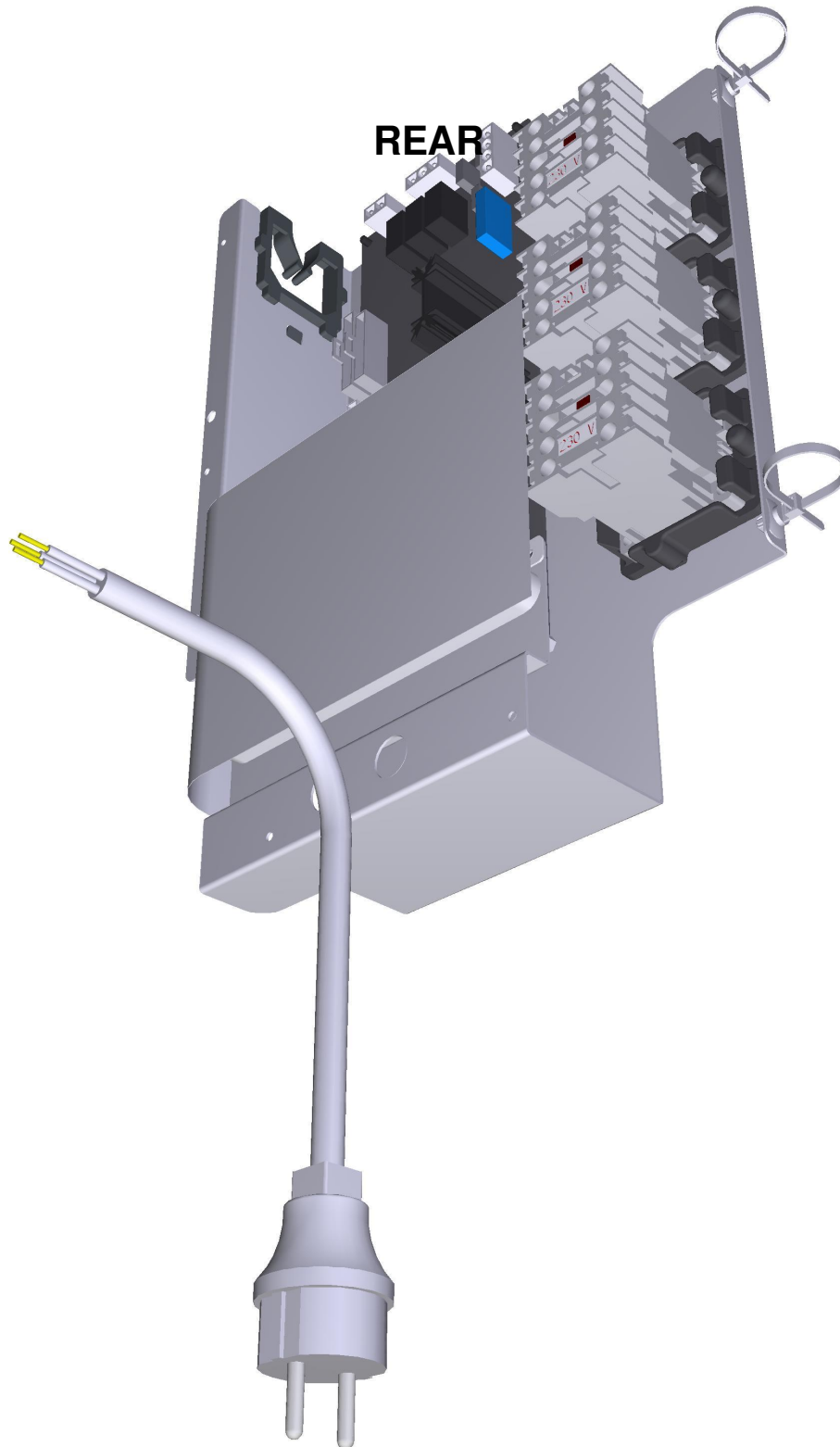

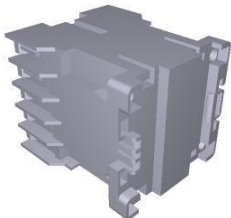

ASM4070A/0.D01 - General overview





COMPONENT			SPARE PART																		
Code	Description	Image	Code	Description	Kit components																
0H7508A	DECKOVEN SERIES 6 COMPONENT HOLD PANEL		0H7508A1	DECKOVEN SERIES 6 COMPONENT HOLD PANEL																	
VE1115A	20 A 230V 4 POLES MINICONTACTOR		KVE1115A	20A 230V 4 POLES MINICONTACTOR KI	<table border="1"> <thead> <tr> <th>Code</th> <th>Description</th> <th>Qty</th> <th>UOM</th> </tr> </thead> <tbody> <tr> <td>VE1115A0</td> <td>20 A 230V 4 POLES MINICONTACT OR</td> <td>1.000</td> <td>PC</td> </tr> <tr> <td>VM1075A1</td> <td>PLASTIC CLIP TO FIX CONTACTORS</td> <td>4.000</td> <td>PC</td> </tr> </tbody> </table>	Code	Description	Qty	UOM	VE1115A0	20 A 230V 4 POLES MINICONTACT OR	1.000	PC	VM1075A1	PLASTIC CLIP TO FIX CONTACTORS	4.000	PC				
Code	Description	Qty	UOM																		
VE1115A0	20 A 230V 4 POLES MINICONTACT OR	1.000	PC																		
VM1075A1	PLASTIC CLIP TO FIX CONTACTORS	4.000	PC																		
VM1056A	SMALL CONTACTOR BRACKET VE1115A		VM1056A0	SMALL CONTACTOR BRACKET VE1115A																	
PE1960B	DECK OVEN POWER BOARD		KPE1960B	MECH. SAFETY SWITCH DECK POWER BOARD KIT	<table border="1"> <thead> <tr> <th>Code</th> <th>Description</th> <th>Qty</th> <th>UOM</th> </tr> </thead> <tbody> <tr> <td>PE1960B1</td> <td>DECK OVEN POWER BOAR</td> <td>1.000</td> <td>PC</td> </tr> <tr> <td>VI1850A0</td> <td>TCB M4x6 SCREW</td> <td>6.000</td> <td>PC</td> </tr> <tr> <td>VM1745A0</td> <td>CARD SUPPORT</td> <td>6.000</td> <td>PC</td> </tr> </tbody> </table>	Code	Description	Qty	UOM	PE1960B1	DECK OVEN POWER BOAR	1.000	PC	VI1850A0	TCB M4x6 SCREW	6.000	PC	VM1745A0	CARD SUPPORT	6.000	PC
Code	Description	Qty	UOM																		
PE1960B1	DECK OVEN POWER BOAR	1.000	PC																		
VI1850A0	TCB M4x6 SCREW	6.000	PC																		
VM1745A0	CARD SUPPORT	6.000	PC																		
VM1745A	CARD SUPPORT		KVM1745A	BOARD SUPPORT 10 PCS KIT	<table border="1"> <thead> <tr> <th>Code</th> <th>Description</th> <th>Qty</th> <th>UOM</th> </tr> </thead> <tbody> <tr> <td>VM1745A0</td> <td>CARD SUPPORT</td> <td>10.000</td> <td>PC</td> </tr> </tbody> </table>	Code	Description	Qty	UOM	VM1745A0	CARD SUPPORT	10.000	PC								
Code	Description	Qty	UOM																		
VM1745A0	CARD SUPPORT	10.000	PC																		

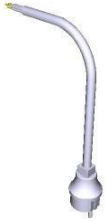
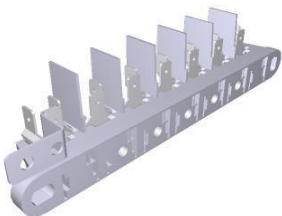

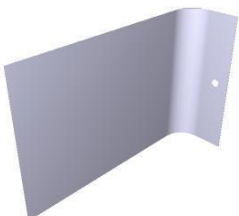
COMPONENT			SPARE PART										
Code	Description	Image	Code	Description	Kit components								
CE1580A	SCHUKO PLUG + 3G X 1,5 MMQ CABLE		CE1580A0	SCHUKO PLUG + 3G X 1,5 MMQ CABLE									
MR1004A	41A 450V 7 POLES TERMINAL		KMR1004A	7FTW 1+2+3/4+5+6 TERMINAL BLOCK KIT	<table border="1"> <thead> <tr> <th>Code</th> <th>Description</th> <th>Qty</th> <th>UOM</th> </tr> </thead> <tbody> <tr> <td>MR1004A1</td> <td>41A 450V 7 POLES TERMINAL</td> <td>1.000</td> <td>PC</td> </tr> </tbody> </table>	Code	Description	Qty	UOM	MR1004A1	41A 450V 7 POLES TERMINAL	1.000	PC
Code	Description	Qty	UOM										
MR1004A1	41A 450V 7 POLES TERMINAL	1.000	PC										
VM1188A	POWER BOARD WIRES PASS-THROUGH		KVM1188A	POWER BOARD WIRES PASS-THROUGH 10PCS KIT	<table border="1"> <thead> <tr> <th>Code</th> <th>Description</th> <th>Qty</th> <th>UOM</th> </tr> </thead> <tbody> <tr> <td>VM1188A0</td> <td>POWER BOARD WIRES PASS-THROU GH</td> <td>10.000</td> <td>PC</td> </tr> </tbody> </table>	Code	Description	Qty	UOM	VM1188A0	POWER BOARD WIRES PASS-THROU GH	10.000	PC
Code	Description	Qty	UOM										
VM1188A0	POWER BOARD WIRES PASS-THROU GH	10.000	PC										
VM1745A	CARD SUPPORT		KVM1745A	BOARD SUPPORT 10 PCS KIT	<table border="1"> <thead> <tr> <th>Code</th> <th>Description</th> <th>Qty</th> <th>UOM</th> </tr> </thead> <tbody> <tr> <td>VM1745A0</td> <td>CARD SUPPORT</td> <td>10.000</td> <td>PC</td> </tr> </tbody> </table>	Code	Description	Qty	UOM	VM1745A0	CARD SUPPORT	10.000	PC
Code	Description	Qty	UOM										
VM1745A0	CARD SUPPORT	10.000	PC										
VM2617A	DECK TERMINAL BLOCK PROTECTIO		VM2617A0	DECK TERMINAL BLOCK PROTECTIO									



ASM4073B/0.D00 - General overview

FRONT

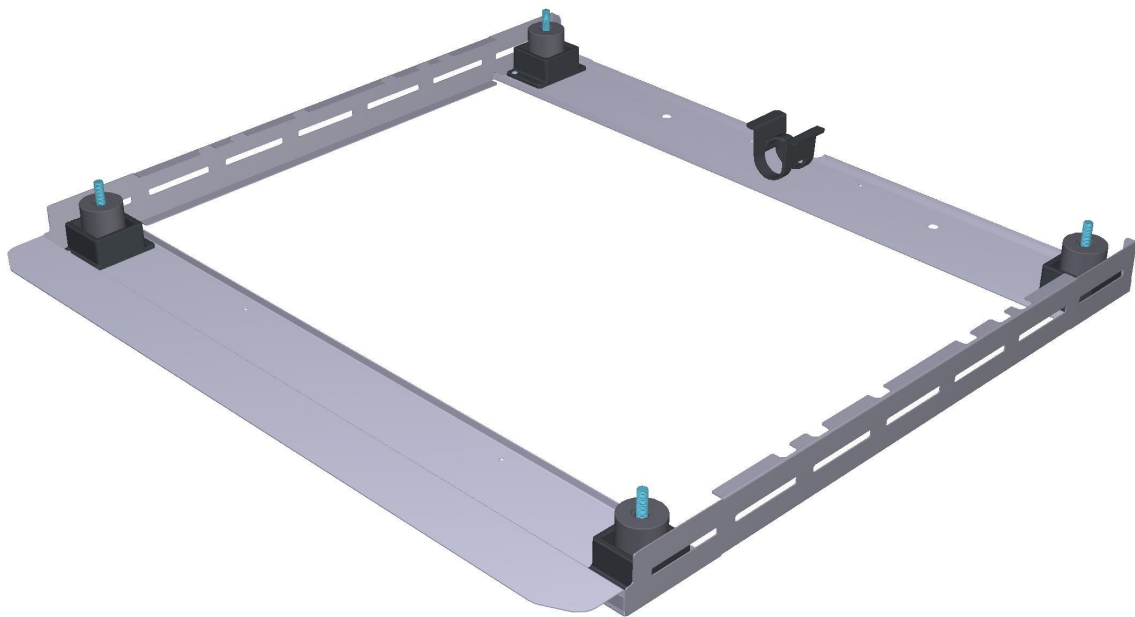





ASM4073B/0.D00 - General overview

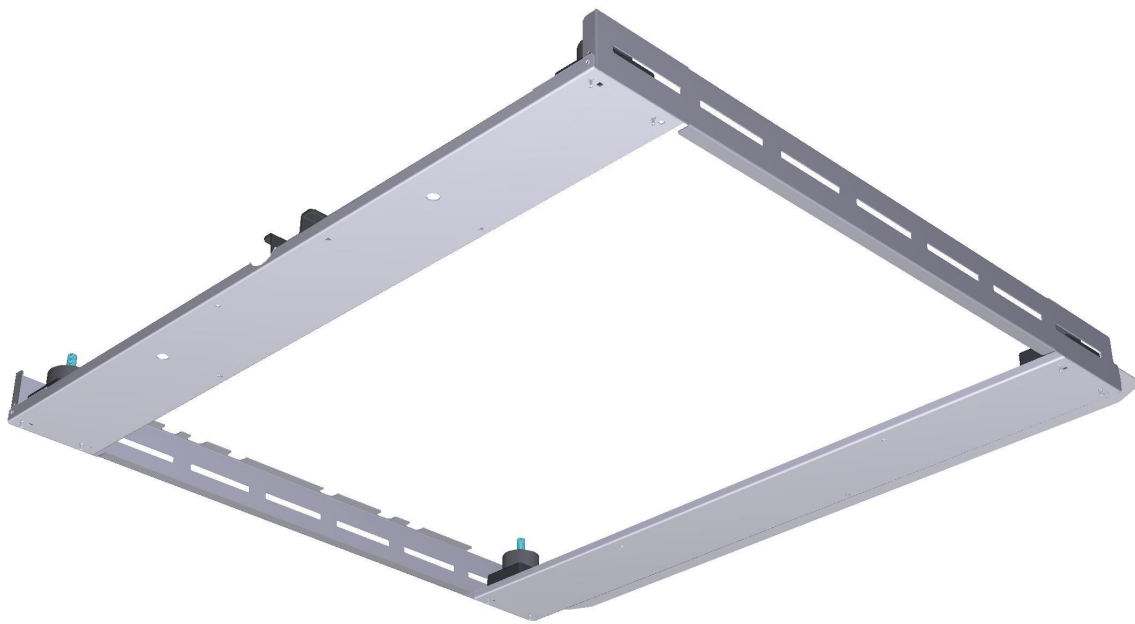

REAR

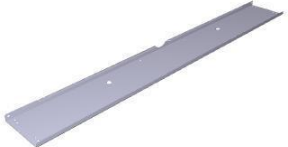
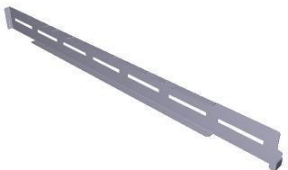
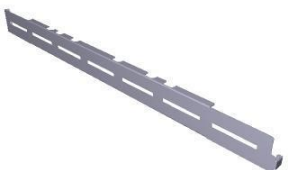



COMPONENT			SPARE PART														
Code	Description	Image	Code	Description	Kit components												
0H7463B	FRONT UPPER PROTECTIVE PROFILE		0H7463B0	FRONT UPPER PROTECTIVE PROFILE													
0H7465B	BACK PROTECTIVE PROFILE		0H7465B0	BACK PROTECTIVE PROFILE													
0H7466A	DECKTOP RIGHT UPPER LATERAL PROFILE		OUTOFPRODUCTIO	ITEM OUT OF PRODUCTION													
0H7467A	DECKTOP LEFT UPPER LATERAL PROFILE		OUTOFPRODUCTIO	ITEM OUT OF PRODUCTION													
PD1075A	PD1074 FOOT LOCKING BRACKET		KPD1075A	OVEN FOOT STOPPING BRACKET 4 PCS KIT	<table border="1"> <thead> <tr> <th>Code</th> <th>Description</th> <th>Qty</th> <th>UOM</th> </tr> </thead> <tbody> <tr> <td>PD1075A1</td> <td>PD1074 FOOT LOCKING BRACKET</td> <td>4.000</td> <td>PC</td> </tr> <tr> <td>V11950A0</td> <td>ST. STEEL 4,2X13 TCB SELF-DRILLIN G SCREW</td> <td>8.000</td> <td>PC</td> </tr> </tbody> </table>	Code	Description	Qty	UOM	PD1075A1	PD1074 FOOT LOCKING BRACKET	4.000	PC	V11950A0	ST. STEEL 4,2X13 TCB SELF-DRILLIN G SCREW	8.000	PC
Code	Description	Qty	UOM														
PD1075A1	PD1074 FOOT LOCKING BRACKET	4.000	PC														
V11950A0	ST. STEEL 4,2X13 TCB SELF-DRILLIN G SCREW	8.000	PC														



COMPONENT			SPARE PART										
Code	Description	Image	Code	Description	Kit components								
VM2390A	MM H60 DECKTOP FOOT		VM2390A0	MM H60 DECKTOP FOOT									
VM2035A	DRAIN PIPE SUPPORT		KVM2035A	DRAIN PIPE SUPPORT 2 PCS. KI	<table border="1"> <thead> <tr> <th>Code</th> <th>Description</th> <th>Qty</th> <th>UOM</th> </tr> </thead> <tbody> <tr> <td>VM2035A0</td> <td>DRAIN PIPE SUPPORT</td> <td>2.000</td> <td>PC</td> </tr> </tbody> </table>	Code	Description	Qty	UOM	VM2035A0	DRAIN PIPE SUPPORT	2.000	PC
Code	Description	Qty	UOM										
VM2035A0	DRAIN PIPE SUPPORT	2.000	PC										